

The Project Gutenberg EBook of A New Astronomy, by David Peck Todd

This eBook is for the use of anyone anywhere at no cost and with almost no restrictions whatsoever. You may copy it, give it away or re-use it under the terms of the Project Gutenberg License included with this eBook or online at www.gutenberg.net

Title: A New Astronomy

Author: David Peck Todd

Release Date: February 13, 2011 [EBook #35261]

Language: English

Character set encoding: ISO-8859-1

*** START OF THIS PROJECT GUTENBERG EBOOK A NEW ASTRONOMY ***

Produced by Susan Skinner, Jonathan Webley, Marilyn
Fraser-Cunliffe and the Online Distributed Proofreading
Team at <http://www.pgdp.net>

Transcriber's Note

Figures may have been moved with respect to the surrounding text.
Presentational changes have been made without comment.



PLATE I.—TOTAL ECLIPSE OF THE SUN (from a painting by Kranz, from *Himmel und Erde*, edited by Dr. Schwahn) Page 264.

A
NEW ASTRONOMY

BY
DAVID TODD

M.A., PH.D.

*Professor of Astronomy and Navigation and Director of the Observatory
Amherst College*



*"Hypothesis non fingo"
Is. Newton*

Copyright, 1897 and 1906, by American Book Company
NEW YORK . . . CINCINNATI . . . CHICAGO
AMERICAN BOOK COMPANY

—‘*Contemplated as one grand whole, astronomy is the most beautiful monument of the human mind, the noblest record of its intelligence.*’—LA PLACE

To
D. W. J. and A. C. J.
in grateful memory
of ‘Coronet’ Day
❖

—‘*The attempt to convey scientific conceptions, without the appeal to observation, which can alone give such conceptions firmness and reality, appears to me to be in direct antagonism to the fundamental principles of scientific education.*’—HUXLEY

Preface

Neglect hitherto of the availability of astronomy for a laboratory course has mainly led to the preparation of this *New Astronomy*. Written purely with a pedagogic purpose, insistence upon rightness of principles, no matter how simple, has everywhere been preferred to display of precision in result. To instance a single example: although the pupil's equipment be but a yardstick, a pinhole, and the 'rule of three,' will he not reap greater benefit from measuring the sun for himself (page 230) than from learning mere detail of methods employed by astronomers in accurately measuring that luminary?

Astronomy is preëminently a science of observation, and there is no sufficient reason why it should not be so studied. Thereby will be fostered a habit of intellectual alertness which lets nothing slip. Sixteen years' experience in teaching the subject has taught me many lessons that I have endeavored to embody here. Earth, air, and water (merely material things) are always with us. We touch them, handle them, ascertain their properties, and experiment upon their relations. Plainly, in their study, laboratory courses are possible. So, too, is a laboratory course in astronomy, without actually journeying to the heavenly bodies; for light comes from them in decipherable messages, and geometric truth provides the interpretation. But the student should learn to connect fundamental principles of astronomy with tangible objects of the common sort, somewhat as in physics and chemistry; and I have aimed to indicate practically how teachers and pupils of moderate mechanical deftness can themselves make the apparatus requisite for illustrating many of these principles. All of it has been repeatedly constructed; and its use should pave the way to better equipment for more advanced study.

Especial attention has been accorded the recommendations of 'The Committee of Ten' on secondary school studies (1892); the specifications concerning astronomical instruction published by the Board of Regents of the state of New York (1895); and the Action of the Editorial Board of *The Astrophysical Journal* with regard to Standards in Astrophysics and Spec-

trosopy (1896).

In order to secure the fullest educational value, I have aimed to present astronomy, not as mere sequence of isolated and imperfectly connected facts, but as an inter-related series of philosophic principles. The geometrical concept of the celestial sphere is strongly emphasized; also its relation to astronomical instruments. But even more important than geometry is the philosophical correlation of geometric systems. Ocean voyages being no longer uncommon, I have given rudimental principles of navigation in which astronomy is concerned. Few young students may ever see the inside of an observatory; but that is reason for their knowing about the instruments there, and prizing opportunities to visit such institutions.

Everywhere has been kept in mind the importance of the student's thinking rather than memorizing. Mere memorizing should be rendered facile; in treating of the planets, I have therefore presented our knowledge of those bodies, not subdivided according to the planets themselves as usually, but according to especial elements and features. The law of universal gravitation has received fuller exposition than commonly in elementary books, its significance demanding this. Biographic notes, intrusions in the text, have been relegated to the Index.

In conclusion, I desire to thank Professor Newcomb of Washington, Professor Pickering, Director of Harvard College Observatory, and my colleague, Professor Kimball, for helpful suggestions on the proof sheets. A few illustrations have been reëngraved from the *Lehrbuch der Kosmischen Physik* of Müller and Peters. For many of the excellent photographs, reader, publisher, and author are indebted to the courtesy of astronomers, in particular to M. Tisserand, late Director of the Paris Observatory, to the Astronomer Royal, to Professor Pickering, to Professor Hale; also to Dr. Isaac Roberts and Professor Barnard, both of whose series of astronomical photographs have received the highly honorable award of the gold medal of the Royal Astronomical Society.

DAVID TODD.

AMHERST COLLEGE OBSERVATORY.

Contents

I.	Introductory	7
II.	The Language of Astronomy	21
III.	The Philosophy of the Celestial Sphere	37
IV.	The Stars in their Courses	51
V.	The Earth as a Globe	67
VI.	The Earth Turns on its Axis	85
VII.	The Earth Revolves Round the Sun	115
VIII.	The Astronomy of Navigation	147
IX.	The Observatory and its Instruments	167
X.	The Moon	197
XI.	The Sun	227
XII.	Eclipses of Sun and Moon	257
XIII.	The Planets	277
XIV.	Argument for Gravitation	327
XV.	Comets and Meteors	343
XVI.	The Stars and the Cosmogony	367

Chapter I

Introductory

Astronomy is the science pertaining to all the bodies of the heavens. Parent of the sciences, it is the most perfect and beautiful of all. Sir William Rowan Hamilton, the eminent mathematician, has called astronomy man's golden chain between the earth and the visible heaven, by which we 'learn the

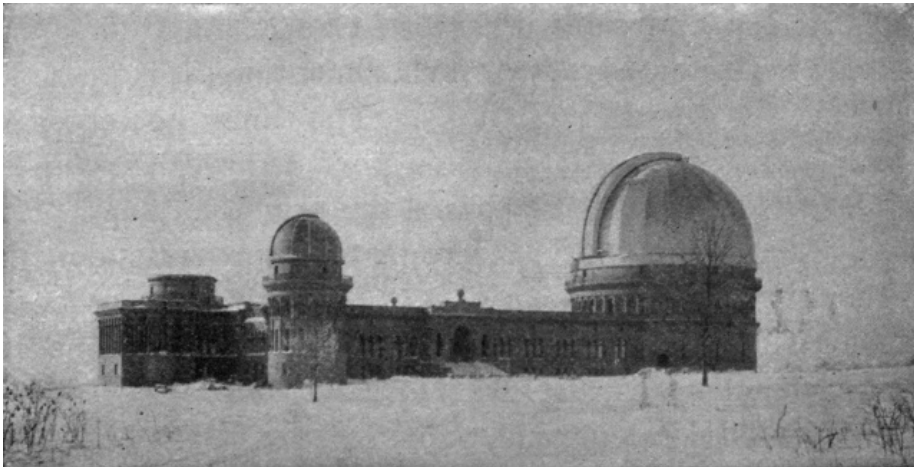

The Yerkes Observatory, Professor Edwin B. Frost, Director

language and interpret the oracles of the universe.' This noble science is to man a possession both old and ancestral, passing with resistless progress from simple shepherds of the Orient watching their flocks by night, to the rulers of ancient empires and the giants of modern thought; until to-day the civilized world is dotted with observatories equipped with a great variety of instruments for weighing and measuring and studying the celestial bodies, each of these observatories vying with the others in pure enthusiasm for new knowledge of the infinite spaces around us.

Astronomy a Useful Science.—Many devoted lives have been grandly spent in pursuit of this branch of learning; and it would hardly be possible for any one who has given even a general glance at their unselfish history to make the vulgar inquiry, ‘What’s the use?’ Only a very small and unambitious mind ever asks this question about any science which adds to the sum total of our actual knowledge, least of all with reference to this,—one of the most practical of all sciences. Astronomy binds earth and heaven in so close a bond that it even maps the one by means of the other, and guides fleet and caravan over wastes of sea and sand otherwise trackless and impassable. By faithful study, even for a short time, it is possible to discover many of these uses. They may not at once appear to put money into men’s pockets or clothes upon their backs; but we have passed the primitive stage of a rudely toiling community, where material progress alone is the thought and aim.

Especial Uses.—To specify in part the relations in which astronomy is useful: (1) In *chronology*,—fixing many disputed dates of ancient battles,

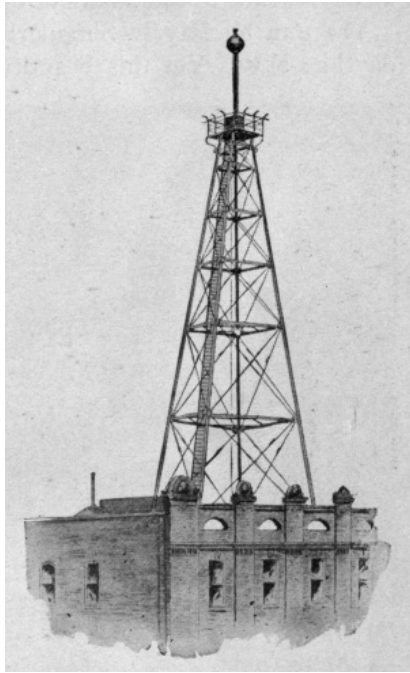

The Time-ball at New York

the reigns of kings, and other important historic events, and establishing the exact length of the units of time requisite for the calendar. For example, the surest basis of the chronology of ancient Assyria rests upon an eclipse of the sun observed in Nineveh in the middle of the reign of Jeroboam the Second, which modern astronomical calculations prove to have taken place on the 15th of June, B.C. 763. (2) In *navigation*—conducting ships from port to port, almost without risk, thereby saving human life and lessening the cost of many of the necessaries of existence. The great national observatory at Greenwich (page 377) is one of those founded for the especial and practical purpose of improving the astronomical means of navigation. (3) In *geodesy* and in *surveying*,—enabling us to ascertain the size of the earth, make accurate maps of

its continents and oceans, and run boundaries of countries and estates. (4) In determining exact *time*,—a vast convenience in all the affairs of life, particularly in the operation of railways. In many large cities, the dropping of

a ball on a high tower indicates exact noon. Every good watch has been carefully rated by an accurate clock (perhaps in some observatory), which again has been corrected by observations of the fixed stars—a knowledge of the precise positions of which depends upon the faithful patience of a multitude of astronomers who have given their lives to this work in the past. Indeed, it is hardly an exaggeration to say that there is no civilized person in existence whose comfort is not enhanced, whose life is not rendered more worth the living, or who is not affected, at least indirectly, by the work of astronomers, and by those who, though not astronomers, are yet practically applying the principles of this science to the affairs of everyday life.

The Sun by Day.—Singularity few persons regard the daytime sky. Yet this beautiful and ever-varying spectacle may be seen and enjoyed by all;

perhaps that is one reason why it is so little thought of. Even the sordid city court, the worst tenement district, may have its strip of blue above, far away from noise and uncleanness. No buildings are high enough to shut out this heavenly gift entirely. The study of the sky in daylight, especially its clouds, is properly part of a separate science,—meteorology as distinguished from astronomy. The marvelous sun, too, by which, as will be seen, we live and move and have our being, is held hardly less a matter of course. Here it is that meteorology joins on the boundary of the science we take up to-day; for the sun is one of the chief objects of study in modern astronomy,—its distance, its vast size, its apparent motion, the sources of its intense light and heat, its constantly changing spots, its con-

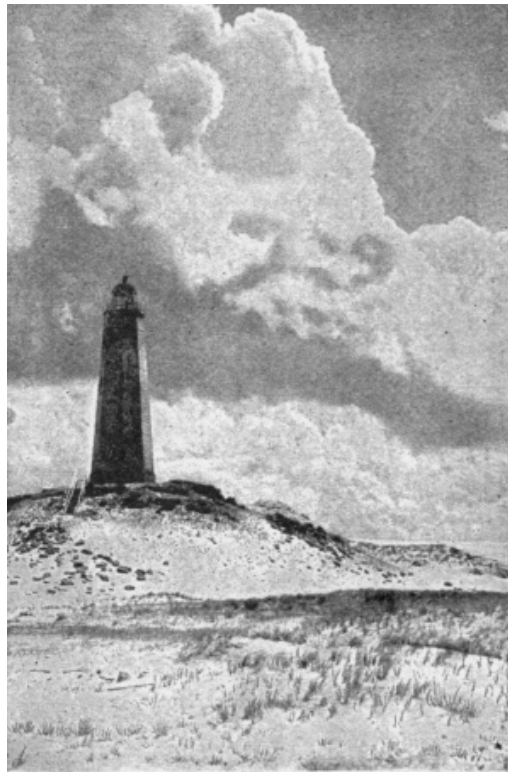

Clouds of the Daytime Sky (photographed by Henry)

stitution, the hydrogen prominences, which seem to spring from its edge as tongue-like flames, and its energies, tirelessly radiated into space and regnant in all the forms of life upon the earth, no less than in all those



PLATE II.—THE SUN AS REVEALED BY TELESCOPE AND SPECTROSCOPE. (*Trouvelot*, from *Annals of Harvard College Observatory*)

phenomena of the atmosphere which we call weather. Many of the spots on the sun are larger than our globe, like the one here pictured. Without fine instruments carefully adjusted, the prominences cannot be seen except during total eclipses of the sun.

The Stars by Night.—But this sense of everyday usualness in great part gives way, once the sun has set, and the stars have come forth, as if from their daytime hiding. Of course they fill the sky just as truly when the world is flooded with sunlight, shining all in their appointed places, where the brighter ones may be seen with the telescope during the day; but their feebler light is conspicuous only when this greater brilliance is withdrawn from our horizon, or when the moon comes in between us and the sun, causing a total eclipse. Immanuel Kant, a great German philosopher, has said that two things filled him with ceaseless awe,—the starry heavens above and the moral law within.



An Average Sunspot (Moreux)

Even the most prosaic cannot but notice and revere the night-time sky, and few are so hopelessly unimaginative as not to be impressed by the dark blue dome spangled with its myriad stars. The positions of the stars with reference to one another seem to remain constant, although they are continually changing their places relatively to objects on the earth. Hence the term *fixed stars*. But this is only seemingly the proper expression. In reality, all are speeding through space at very high velocities, but so infinitely removed are the stars from us that they appear to be at rest. Although quite the reverse, as we now know, from 'fixed,' the term is still used, because in the astronomically brief period from generation to generation, the changes are so slight that the naked eye is powerless to detect them.

Number of the Brighter Stars.—In ancient times the brilliant host of the nightly sky was thought to be countless; but surprising as it may seem, the stars actually visible to the unaided eye at a single place in the United



The Night-time Sky in a Great City

States do not exceed 2000 or 3000, and only upon exceptionally favorable nights may so many be counted without a telescope. As an average, on what may be termed clear nights, the number thus ordinarily seen at any given time is rather less than 2000; but this number varies greatly with changing conditions of our atmosphere. If one were to keep count, through the year, of all the stars visible to the naked eye in all that part of the heavens ever seen from a single place in the United States, the total number would be about 4000.

Number of the Telescopic Stars.—By the use of a small telescope, or even an opera glass, the number of visible stars is increased enormously. Even in Galileo's time, his 'optick tube' revealed an unsuspected and unnumbered host, beyond the dreams of any primitive astronomer. With our modern telescopes (in which the object glass of almost every famous new one has been an advance in size upon all its predecessors) the 'blue field of heaven' is estimated to contain at least 100,000,000 stars. Beyond what is shown even by these telescopes are the remarkable revelations of celestial photography, which reproduces unerringly upon the sensitive plate uncounted millions of other stars too faint for the eye to detect, even when aided by the most powerful optical means at our command. In a single field embracing but a slight fraction of the whole sky, recently charted with the Bruce telescope of Harvard Observatory (the largest photographic instru-

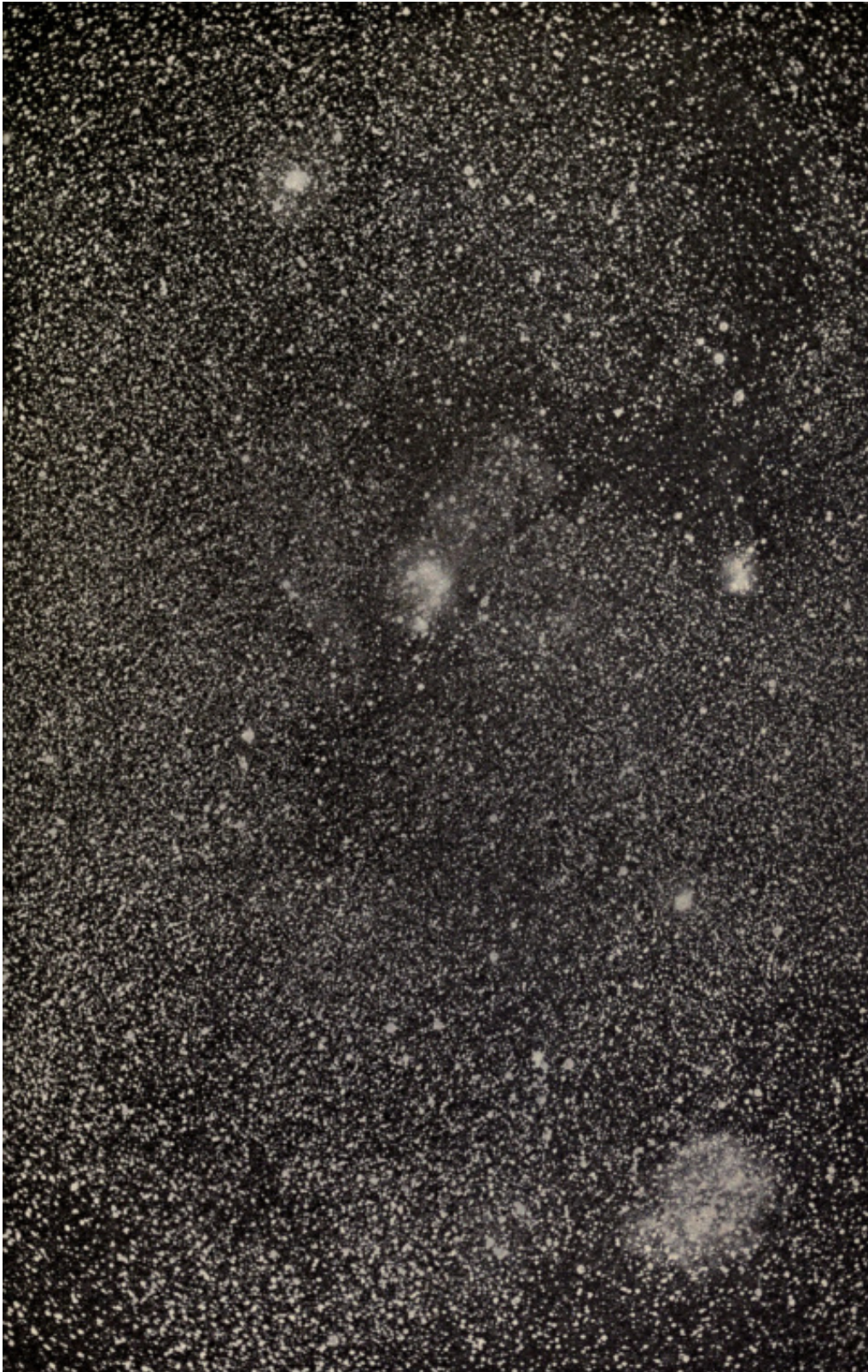

The Milky Way near the Star 15 Monocerotis, $R = 6$ h. 35 m., Decl. N. 10°
(photographed by Barnard, 1894. Exposure $3\frac{1}{2}$ hours)

ment in existence), there were counted no less than 400,000 stars. And who can say where this stupendous array ceases?

The Constellations.—The names and positions of the brighter stars are very easy to remember. By even a casual glance at the sky on any clear night, it will be seen that the stars make all sorts of figures with one another,—squares, triangles, half circles,—and fanciful combinations may be traced in all directions. The ancients called these various figures after their gods and heroes, dividing them into 48 groups, largely named after the characters associated with the voyage of the fabled ship *Argo*. Although these constellations bear little real resemblance to the men, animals, and other objects named, they too are easily learned. Properly that is not astronomy, but merely geography of the heavens; yet it is an interesting and popular branch of knowledge, often leading to farther studies into the most absorbing and uplifting of sciences.



The Moon (photographed by the Brothers Henry)

The Moon.—Of all celestial bodies, meteors alone excepted, the moon is the nearest to us, and apparently of about the same size as the sun; but this is the result of a somewhat curious coincidence, by which the sun, although 400 times broader than the moon, is also very nearly 400 times farther away. Even with a small telescope we may generally see the deep craters and the rugged mountain peaks of the moon, partly illuminated by sun-

light, while the rest of our satellite is turned away from the sun, lying in shadow and seen very faintly by the sunlight falling upon it after reflection from the earth. Our companion world is dead and cold, its air and

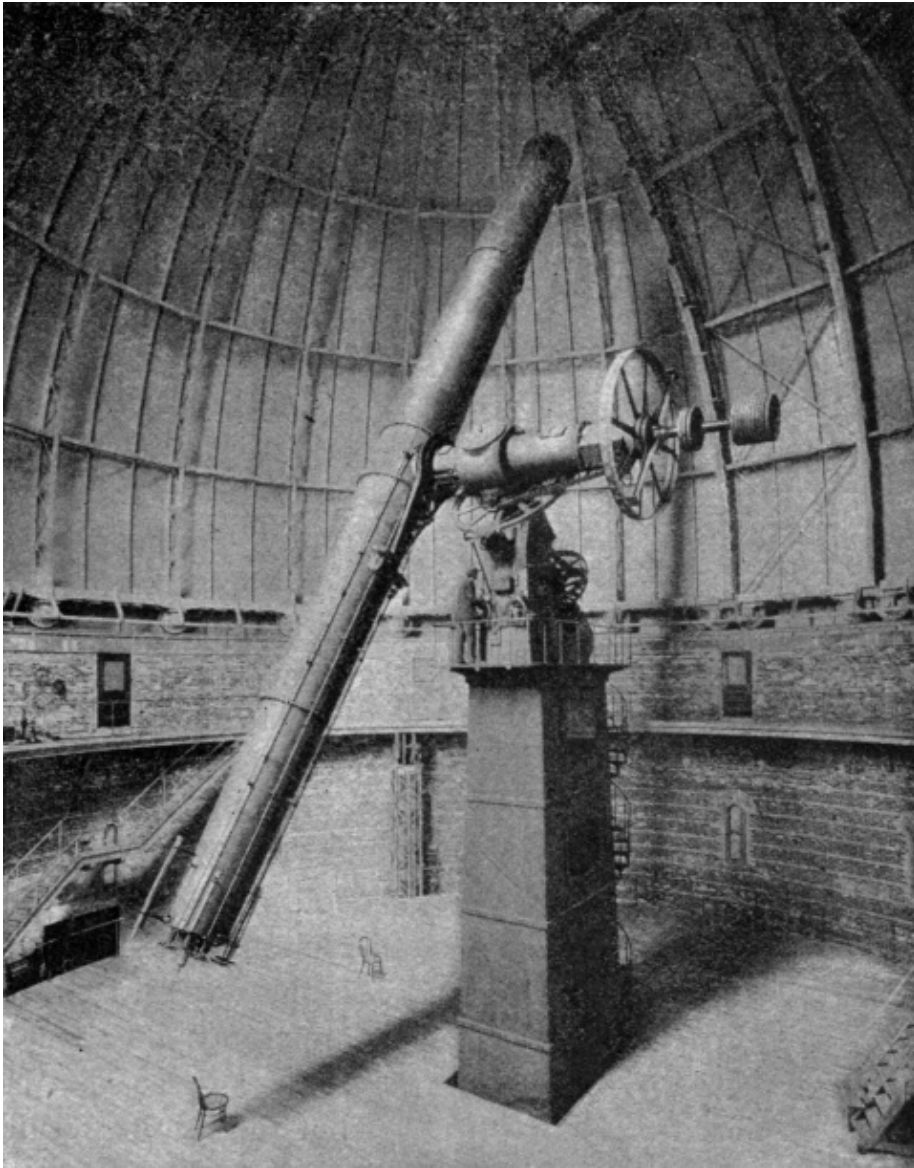

The Yerkes Telescope of the University of Chicago

This great telescope was mounted in 1896–97 at Williams Bay, Wisconsin. It is the principal instrument of the Yerkes Observatory, and cost about \$125,000. The glasses for its 40-inch lenses, the largest in America, were made by M. Mantois of Paris, ground and figured by Alvan Clark & Sons of Cambridgeport; and the tube and all the intricate machinery for handling the telescope with ease and precision were built by Warner & Swasey of Cleveland.

water almost certainly gone, so that no amount of brightest sunshine can of itself bring back any warmth of life. Earth and other planets are dark, too, on the surface, save for what the sun bestows of brightness and warmth; but our own planet and some of the others are blessed with an encircling atmosphere, best gift after sunlight itself, to save and store for our use the sun's heat shed lavishly upon us.



Jupiter in a Small Telescope

The Planets.—When frequent looking at the nightly sky has somewhat familiarized the evening constellations,—different at the same hour at the various seasons of the year,—one may notice three or four very bright stars which do not twinkle. A few evenings' watching will show that they are slowly changing their positions relatively to other and fainter stars about them. These are the planets ('wanderers'), and will at first be thought and called stars; but although speaking in the most gen-

eral terms, it is proper to refer to them as stars, they are worlds, among which the earth is one, traveling round the sun in nearly circular paths. Like our own planet, they receive their light from the central orb, and reflect it afar. The planets and all their moons (called satellites), as well as our moon, give light only as reflected sunshine,—second-hand. Some of the planets are brighter than most stars, only because they are very much nearer to us and to the sun.

Differences between Stars and Planets.—Besides the noticeable change of position of the planets, and their shining by reflected light, another difference between planets and fixed stars is that, when seen through a telescope, planets appear larger in size than with the naked eye. This the stars never do. Most planets have an appreciable breadth, called the *disk*; and this seems to grow larger as the power of telescopes is increased. Stars, on the contrary, seem to be mere points of light, intensely luminous, and infinitely far away. They increase only in brilliancy with the size of our largest glasses; and even the strongest lenses cannot produce the slightest effect upon the apparent size of these stupendously distant blazing suns. Also some of the planets as seen in the telescope show phases; in particular, Venus, the brightest planet, a familiar glory of the western sky, passing through all the changing phases of our moon,—full, quarter, and crescent.

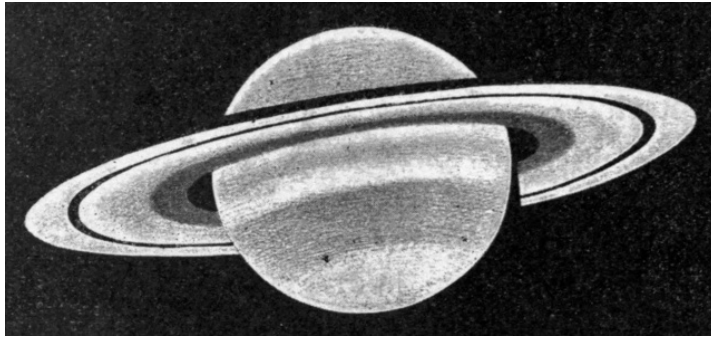

The Planet Saturn in 1894 (drawn by Barnard with the Lick Telescope)

A planet called Saturn is surrounded by a thin ring, as shown in above engraving. It suggested a process of evolution called the nebular hypothesis, by which stars, planets, and satellites seem to have developed into present forms through the operation of natural laws.

The Fixed Stars are Suns.—All these fixed stars are suns like our own—singularly similar, the modern revelations of the spectroscope tell us, as to material elements composing them. Probably, at their inconceivable distances from us, these suns afford light and heat to uncounted worlds not unlike those in the system of planets to which our earth belongs. But if such planets exist, they are too near their own central luminaries, and too faint for their reflected light ever to reach our far-off eyes. One must think of the vaster brilliance of the sun as due almost wholly to our relative nearness to him. Were the earth to be removed as far from the sun as it is distant from the stars, our lord of day would shrink to the feeble insignificance of an average star.

The Distances of the Stars.—The nearest star is so far from us that its distance in figures, however expressed, remains unapprehended by the human mind. Who can conceive of 25 millions of millions of miles? Yet so remote is our closest stellar neighbor. As the stars vary enormously in their distances from us, so they are equally diverse in their relations to each other. We see them all by the light they emit—light which does not come to us instantaneously, yet with speed almost inconceivably great. While one is taking two ordinary steps, at an average walking pace, light will travel a distance equal to eight times round the world (nearly 200,000 miles). Now, to realize in some sense the enormous distance of the nearest fixed star from our earth, open a Webster's International Dictionary, which contains over 2000 pages of three columns each, or the equivalent. Begin to read as rapidly as you can, and imagine a ray of light to have just left the nearest fixed star

at the instant you began. By the time you have finished a single page, the star's light will have sped onward toward the earth no less than 100,000,000 miles. Imagine that you could keep right on reading, tirelessly and without ceasing, day and night, just as light itself travels—how many pages would you have read when the ray of light from Alpha Centauri, the nearest fixed star, had reached the earth? You would have read it completely through,—not once, or twice, but nearly a hundred times. So enormously distant is this nearest of the stars that, if it were blotted out of existence this present moment, it would continue to shine in its accustomed place for more than three years to come. And other stars whose distances have been measured are a hundredfold more remote.

The Shooting Stars and Comets.—Very frequent celestial sights, especially in April, August, and November, are the swarms of swiftly-falling



The Great Comet of 1858

meteors. They flash across the sky and seem to vanish into the blackness whence they came, burning sparks in the starry firmament. On rare occasions a fragment of a meteor falls down upon the surface of the earth, and many thousands of such specimens are preserved as collections of meteorites in various scientific centers,—Vienna, London, Paris, and Washington. Sometimes they are of iron, and sometimes of stone. Much less common than the spectacle of shooting stars is that of a majestic comet, whose long and graceful tail sweeps many degrees along the sky, sometimes for weeks or even months together. All these wandering visitors, too, must be studied in their place.

General Outline.—We know that the stars are suns; that our sun is one of them, seemingly larger only because very much nearer; that he conducts with him through space our earth and her companion planets with their moons, or satellites; that the stars are all moving through the celestial spaces with great velocity, though at such enormous distances from us that they appear to be almost at rest; that meteors and comets flash into our firmament, the former to perish after one bright, sparkling clash with our atmosphere, while the latter have their known and regular orbits, or paths,

some of them coming back within our sight at predicted intervals.

Gravitation.—The mighty power called gravitation holds all these whirling, flying, incandescent or white-hot, or cold and dead bodies from swerving outside their paths in space; and, little by little, the patience and ingenuity and genius of man have interpreted many of the laws governing them, and have brought to our knowledge manifold facts about them,—their weights and distances, sizes and motions, and even the elemental substances of which they are composed. Their physical appearances, as revealed by telescope and camera, will be abundantly emphasized. But perhaps the most striking fact in all astronomy is that unerring precision with which the heavenly bodies move through the celestial spaces in accordance with this great law of gravitation, whose action enables us to foretell with great accuracy, hundreds of years in advance, the places of planets in the starry heavens, and the exact hour, minute, and second, when eclipses will happen. And progress through the chapters of this book will unfold in part the knowledge gained by astronomers through centuries of careful investigation.

Chapter II

The Language of Astronomy

No one can understand even the simplest truths of astronomy without first learning the language of precision which astronomers use. Only a few terms in this language will be necessary at the outset, and they will be illustrated and ideas of them conveyed by means of common objects and simple pro-

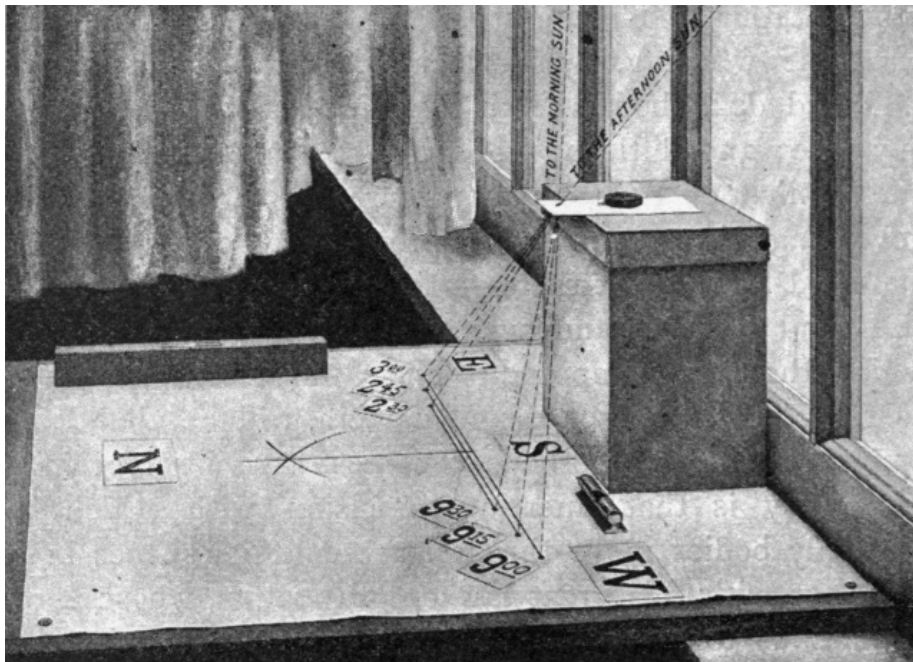

How to find True North (Approximately)

cesses. First, the four cardinal points, east, north, west, and south,—terms in constant use from the remotest antiquity.

How to find the Cardinal Points.—Any sharply-pointed object, firmly set, may be used as a gnomon for finding the cardinal points. But the following

method has greater advantages. Place a carefully leveled board or table so that the sun may fall freely upon it, from about nine o'clock in the morning until three in the afternoon. Fasten securely. Near the sunward end of the table, and about eight inches above it, fix firmly a card with a smooth pin hole through it. This will give a small, oval image of the sun on the table, and its position must be marked at nine o'clock, at a quarter past, and at half after nine; again at half after two in the afternoon, a quarter to three, and three o'clock. The principle involved is that of the gnomon of Anaximander in very compact form. Take especial care that the marked surface, whether board or paper, shall not have moved meanwhile. Draw three straight lines joining the sun marks, as indicated in the picture opposite; connect the nine o'clock mark with the three o'clock one; draw a second line connecting the 9:15 mark with that made at 2:45; and a third, joining the 9:30 and 2:30 marks. These three lines will be nearly parallel,

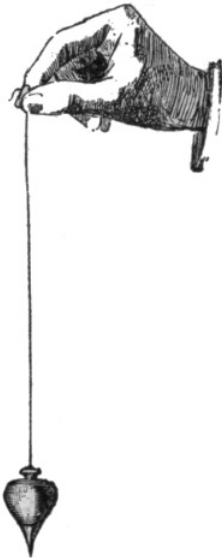

A Plumb-line

and they mark the direction east and west approximately, the east end being indicated by the three afternoon marks. Three pairs of points are better than one, because clouds may interfere with the afternoon observations; also, we can take the average direction of three lines, which will give true east and west more accurately than a single line. By the simple construction in geometry indicated in the illustration, draw a perpendicular to this average line; this perpendicular, then, will lie in the direction north and south, north lying on the right hand as one faces west. Extend these two straight lines indefinitely, and they will mark the four cardinal points called east, north, west, and south.

Plumb-line, Zenith, and Nadir.—Suspend any heavy object by a delicate cord attached to a firm support, and allow it to come to rest. Draw it to one side or the other from its support, and let it swing freely. Such an object capable of swinging is called a pendulum. The force causing it to swing back and forth is called the attraction of gravity. We shall see subsequently that this is the same force that makes all

bodies fall to the earth; also that it holds the moon, our satellite, in its monthly path, or orbit, about us. After swinging back and forth many times, the pendulum will come to rest; and it will do so more quickly if the weight or bob of the pendulum is freely suspended in a basin of water. A pendulum that has stopped swinging becomes a plumb-line. Imagine the cord of the plumb-line extended both upward to the sky and downward through the earth indefinitely. The point overhead where the plumb-line intersects the sky is called the *zenith*; the opposite point is called the *nadir*.

The Apparent or Visible Horizon.—Looking up to the sky, it seems to be arched over us like the inside of a great hollow sphere. The dome of the sky is nearly hemispherical, and seems to most eyes less distant overhead. In ordinary inland regions the sky seems to meet the earth in an irregular and broken line. This is called the apparent or visible horizon; and nearly every

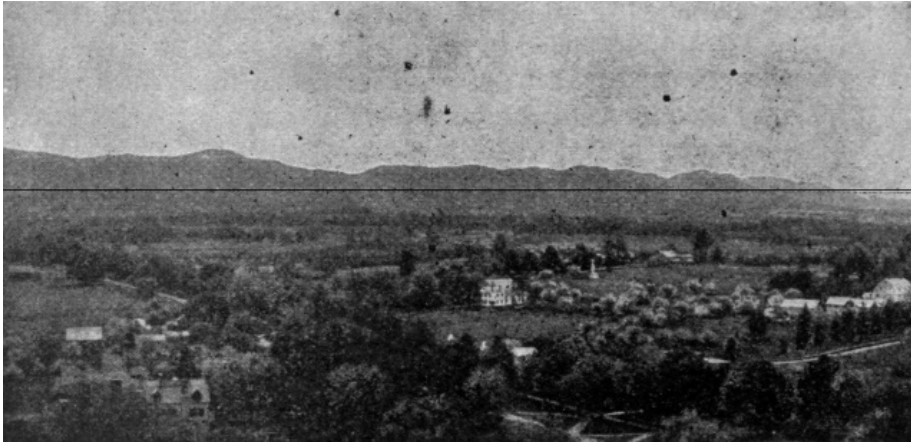

Plane of the Sensible Horizon cuts through the Mountains

point of it, even in locations not especially mountainous, will usually be considerably above the level of the eye. In cities the surrounding buildings, the trees in the park, and the spires of churches will lift themselves into our vision, too near by to allow any observation of the sky at the exact level of the eye. In the country, in Massachusetts, for example, it is not always easy, without ascending some great height, to reduce the obstacles forming the apparent horizon to a minimum; and usually the sensible horizon lies far below them all. Objects relatively near, then, whether houses, grain elevators, churches, forests, or mountains, make irregular curves and broken lines which limit the outward view in every direction. Their outline marks the observer's apparent, or local, or visible horizon.

The Sensible Horizon.—From the surface of the ocean, or from a widely extended plain or prairie, the dome of the sky appears to join the earth in a nearly perfect circle about 25 miles in diameter. In Boston, for instance, we may take the steamer for Nahant, and for a portion of even that short trip our perfect ocean horizon on one side will hardly be interfered with. In New York a boat trip to Far Rockaway or Long Branch will give us a similar opportunity. In Chicago we have a choice of ways to get a complete view of the sensible horizon. A car ride in almost any direction—to Evanston, perhaps—will show widely extended prairies, seeming to stretch to the sky on all sides; far out upon Lake Michigan,

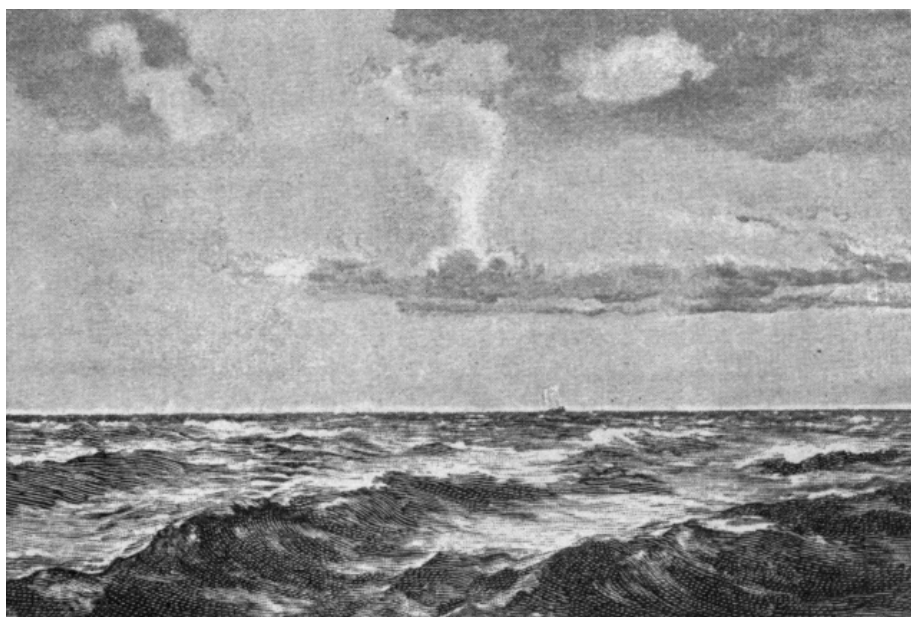

The Visible Horizon on the Ocean

the effect upon the observer is like that of the ocean; or perchance the Auditorium tower may be ascended, and if the distant view is clear, a far-away horizon of the sensible order is within sight. Practically in this circle, the four cardinal points are located. Imagine a plane passed through these four points. It will pass through the eye of the observer, and will essentially be the plane of his sensible horizon, neglecting only a small angle called the dip of the horizon, a term used in navigation, and explained in a later chapter. On a small piece of cardboard draw two lines at right angles, one of them being near the middle of the card. Pierce the card at each end of this line, and draw a piece of twine through the holes. Fasten one end of the twine to some firm object, and suspend a weight of a few pounds by the other end. When the pendulum has come to rest, fasten the bottom of the plumb-line carefully in that position, and stretch it taut. Then twirl the card round, and the second line on it will point everywhere in the direction of the sensible horizon.

The sensible horizon, then, is a plane passing through the point of observation and perpendicular to the plumb-line. When the term *horizon* alone is used, the sensible horizon is meant. It is a fundamental plane of reference in astronomical measurement.

The Terrestrial Sphere.—A sphere is a solid figure all points on whose surface are at the same distance from a point within called the center. The general figure of the earth being spherical, it will be seen that the directions

indicated by the terms north, south, east, and west, if extended in straight lines into space, are true only for a given locality, or position of the observer. This is because he is situated upon the surface of a globe or sphere, and the moment he changes his position upon it, his zenith and horizon and system of cardinal points all change with him. *Down* always means toward the center of this globe; so that if a plumb-line were imagined as extended downward through the earth, at the antipodes it would coincide with the direction *up*. If we go to the opposite side of the globe, changing our longitude by 180° , evidently the directions called east by us in these two remote localities will be exactly opposite to each other in space. So that a continuous line, in order to represent a constant direction, must have a constant curvature, corresponding to that of the surface of the earth. The plane passing through the earth's center parallel to the sensible horizon is called the *rational horizon*.

The Celestial Sphere.—We have spoken about the hemisphere or dome of the sky. It is obvious from geometry that the hemisphere above the sensible horizon must be matched by an equal hemisphere inverted, and lying below it. This complete and regular form, made by the two hemispheres joined, is called the *celestial sphere*. Sun, moon, and all the stars of the firmament are scattered apparently at random upon its inner surface. We need not now concern ourselves about the remoteness of the bodies in the sky. All appear to be at the same distance from us; and the eye unaided is powerless to find out what that distance is. But evidently there may be a very great range in their distances, just as there is in the lights of different sizes on ships in a harbor, or in the night signals along a straight stretch of railway in or near a great city. In either case, on a dark night, an inexperienced person has little to guide him safely in judging what the distances and relative location of the lights may be.

Properties of the Celestial Sphere.—The celestial sphere, notwithstanding its inconceivable magnitude, possesses all the properties of a geometric sphere: not only is every point of its surface equally distant from

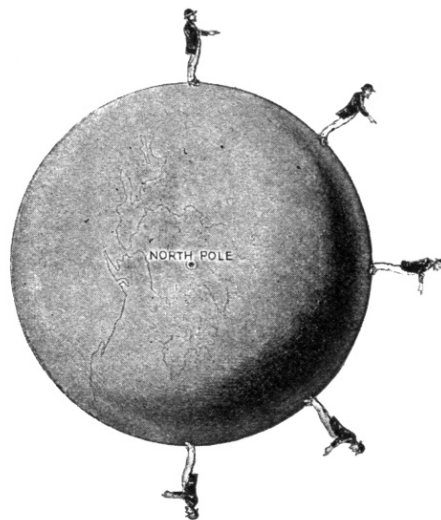

West the same as East at Antipodes

a point within called its center (the point where the observer is), but all planes cutting the sphere through its center trace out circles of equal magnitude upon its surface. These are called *great circles*. All planes cutting the sphere otherwise than through its center trace out small circles upon its surface. Evidently it is possible to imagine upon any sphere as many great circles and as many small circles as may be desired. Three systems of circles of the celestial sphere, with their related points, lines, and arcs, are in common use. They are:

- (A) the Horizon System,
- (B) the Equator System,
- (C) the Ecliptic System.

(A) **The Horizon System.**—The great circle that passes through the four cardinal points is called, as we have seen, the *horizon*. Upon it is

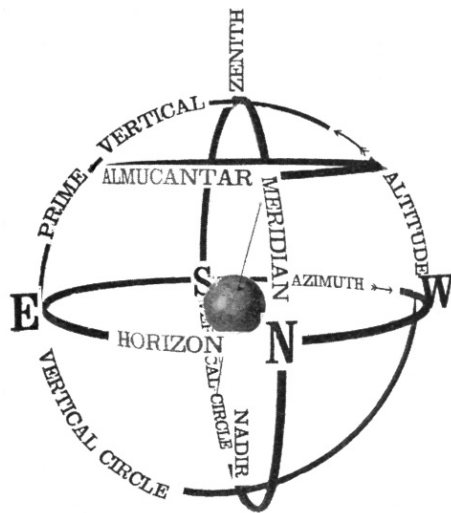

Chief Circles of Horizon System (A)

based a system of circles of the celestial sphere much used in astronomical descriptions and measurements. Any great circle traced on the celestial sphere by a vertical plane passing through the point of observation is called a *vertical circle*. Clearly an indefinitely great number of vertical circles may be imagined as drawn. The planes of all vertical circles intersect each other in a vertical line—the plumb-line extended,—joining zenith and nadir. Two vertical circles are very frequently used, and have especial names: first, the vertical circle passing through the north and south points of the horizon is the *meridian*;

second, the vertical circle at right angles to the plane of the meridian, and passing through the east and west points of the horizon, is called the *prime vertical*. Any small circle of the celestial sphere cutting it parallel to the horizon is called an *almucantar*. Evidently there is no limit to the number of almucantars; one may be imagined as drawn through every star in the sky. The nearer a star is to the zenith, the smaller its almucantar, just as parallels of geographic latitude upon the earth become smaller and smaller as the poles are approached. Three hoops of a barrel tied or tacked together, with all the angles right angles, as in the illustration, form an

excellent representation of horizon, meridian, and prime vertical; a much smaller hoop (near the top) may illustrate an almucantar. Such a concrete model is a necessary aid to many minds in attaining an adequate conception of the abstract circles of the celestial sphere. Essentially they are a pattern of the armillary sphere of the ancient astronomy.

Change of Horizon System with Change of Place.—The terms *horizon*, *meridian*, *prime vertical*, and *almucantar* are generally applied to the circles upon the celestial sphere traced by their planes. The terms are, however, often, and properly, employed to designate the planes themselves. It will be understood that these four terms apply to an observer wherever he may be located upon the surface of the earth. If he remains in a single position, or has an observatory with a single instrument, his horizon plane, meridian, and other circles, planes, and points connected with it, have always a constant and definite position, relative to the observer himself. They are imaginary planes and circles which the observer carries about with him wherever he goes. The moment he changes his locality, by so much even as a few feet, he has thereby changed the position of all this network, or system of celestial circles, by an amount small, to be sure, but readily measurable by the instruments and methods of the modern astronomer.

Diurnal Motion and the Diurnal Arc.—The sun, moon, and stars, in their everyday motion, appear to cross these circles in various directions, and at various angles, and with various velocities. A few evenings' observation will show this. These movements are known as the phenomena of the diurnal motion. Observe the points where the sun rises and sets; if in the latter half of September or March, these will be found to be almost due east and west. As noon approaches, near which time the sun will cross the meridian, his course, in the latitude of the United States, will be found to have been, not upward along the prime vertical, but obliquely toward the south, as illustrated: his paths at various seasons are all in parallel planes. He will reach the highest point when crossing the meridian, and is then said to *culminate*. Onward to sunset he describes an arc almost precisely symmetrical with the forenoon path. This apparent track of the sun through the daytime sky, from sunrise to sunset, is called the *diurnal arc*; and either half of it, between meridian and horizon, is called the *semidiurnal arc*. Similarly observe the moon.

Perhaps it will rise considerably north of east. Watch it as it mounts to the meridian. It will cross this plane only a few degrees south of the zenith, and descend the western half of its diurnal arc, setting about as far north of true west as it rose north of true east. Select very bright stars in other parts of the sky both north and south of sun and moon, and observe where they rise and set

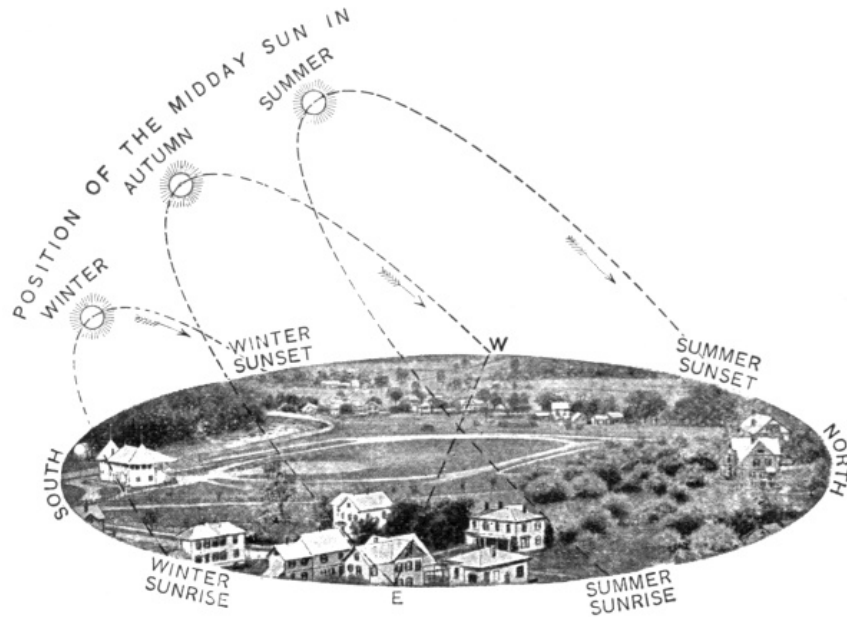

The Midsummer Sun is Highest and its Diurnal Arc is Longest

and culminate. It is apparent, then, that the term *diurnal arc* refers only to the interval during which a celestial object is above the horizon; and this interval of time (for any heavenly body except the sun) may elapse partly during actual day and partly during night, or even entirely during the night-time. For example, note the rising of some bright star near the southeast. How slowly it appears to leave the horizon. Notice its low elevation when it reaches the meridian, and its declining arc in the southwest. Evidently its diurnal arc is very short; it has not been above the horizon more than seven or eight hours in all.

The Diurnal Motion of a Star Overhead.—Next select a bright star almost overhead. Early in September evenings in the United States, Vega (Alpha Lyræ) will be in this position. As it descends toward the west, its course will seem to curve rapidly toward the north; and as it approaches the northwestern horizon, it will seem to go down less and less rapidly, meanwhile moving more and more toward the north. Finally, it will disappear only a few degrees west of true north. In making this circuit from the meridian to the northern horizon, it will have consumed perhaps 10 or 11 hours; and as there will be a similar arc of 10 or 11 hours between meridian and eastern horizon, evidently such a star's diurnal arc may be as much as 20 or 22 hours in length.

The Diurnal Motion of a Circumpolar Star.—Then choose a star

still farther north, but near the meridian, and observe its motion critically. Very noticeable will be the fact of its moving away from the meridian less rapidly than the star just observed. It will not go nearly so far west, and after about six hours it will begin to return toward the north. Then, if we could follow it into the daylight, six hours later still, or about 12 hours after it was first observed, it would be seen nearly due north, and at a considerable distance above the horizon. This plane, in fact, it will never have reached. It will then continue to move backward from west toward east, ascending from the horizon at first very slowly, and making an excursion as far east of the meridian as it was observed to the west. After an interval of 24 hours from the first observation, this star will be seen nearly in the first position, just like any other star, having described an entire small circle of the celestial sphere; and it would have been visible all the time except for the overpowering brilliance of the sun.

The Pole Star.—If we select a star yet farther north, we shall find that it describes an even smaller circle of the celestial sphere. This tentative method alone would enable us, by a few nights' observations, to select that star which describes the smallest circle of all; the bright star known as [Stella] Polaris, or the *pole star*. Next to sun and moon the most important object in the heavens, it is always visible in all places in the United States when the sky is clear, not only by night, but by day with the assistance of a small telescope. The center of the very small circle which Polaris appears to describe every 24 hours is the north pole of the heavens. Also the diurnal paths of all other stars are central about it.

How to find the Pole of the Heavens.—First focus the camera carefully on some very distant object, and mount it in the meridian. Secure it firmly, with the lens directed northward and upward at an angle of about 45° . As soon as the stars are out, and it has become quite dark, take off the cap and leave the plate exposed as long as is convenient, or until the beginning of dawn. Development will then show something like the above, a series of concentric arcs, the shortest and brightest of which will be that of Polaris. Star trails will be broken lines, if clouds temporarily intervene. At the center of all these curving arcs is the celestial pole itself, always situated in the observer's meridian; or strictly speaking, the meridian is the vertical circle passing through the pole of the heavens. If the camera is pointed near the celestial equator, star trails will be straight lines, as on page 31.

(*B*) **The Equator System.**—The north pole of the heavens is a fundamental point of a second system of planes and circles of the celestial sphere, just as the zenith is the primary point of the horizon system. Imagine this horizon system of planes and circles—horizon, prime vertical, meridian, and

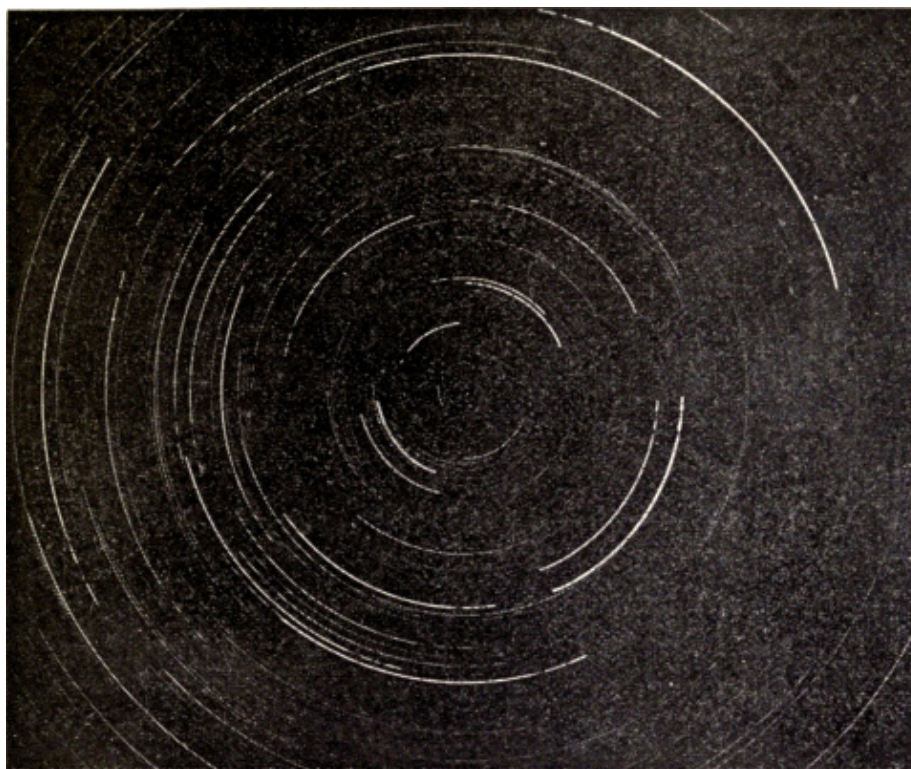

Five-hour Trails of Northern Circumpolar Stars (photographed by Barnard)

almucantar—to be outlined in a connected skeleton upon the vault of the sky. Also think of this skeleton system as pivoted at the east and west points, and free to turn about them. Then move the zenith point northward along the meridian, until it coincides with the north pole. The south point of the horizon will then have traveled upward along the meridian by an angle equal to the distance of the zenith from the north pole. Also the north point of the horizon will have been depressed below it by an equal arc. In this novel position the circles and planes of the celestial sphere need defining anew. What was the zenith is now the north pole of the heavens. The horizon has become the celestial equator, every point of which is distant 90° from the celestial pole, just as the horizon is everywhere 90° from the zenith. What were vertical circles now converge toward the poles, the southern one of which is depressed below the south horizon as much as the northern one is elevated above it. Instead of vertical circles they are called, in this position, meridians of the celestial sphere, or *hour circles*. They correspond to, and are planes extended from, the terrestrial meridians of geography. Almucantars in system (A) become parallels of declination in

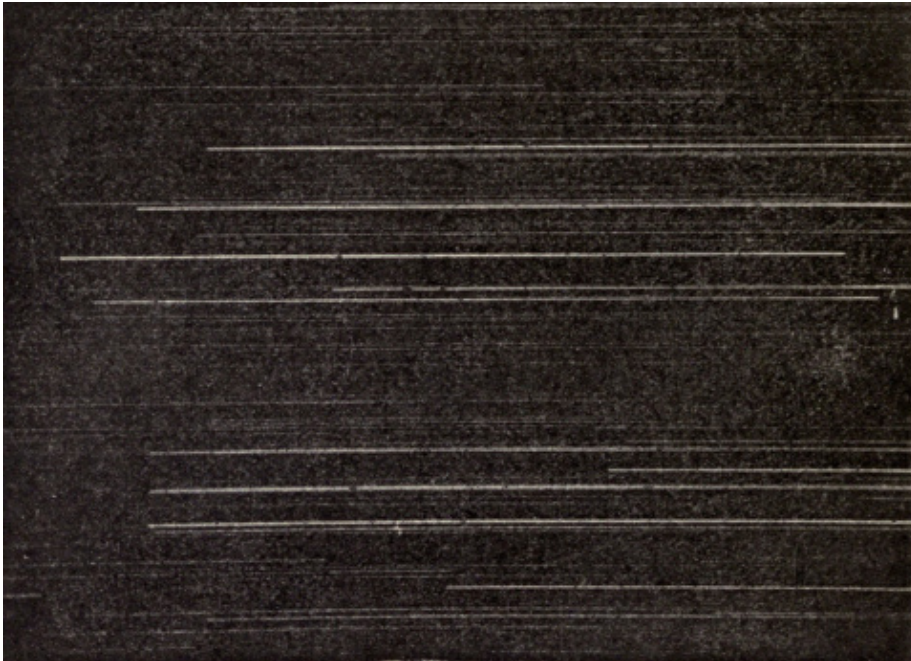

One-hour Trails of Stars in Orion's Belt (photographed by Barnard)

system (*B*).

The Colures.—Evidently an hour circle may, if desired, be drawn through any star of the sky. Two of these hour circles at right angles to each other, have especial names; they are counterparts of prime vertical and meridian in the first or horizon system, and are called the *equinoctial colure* and the *solstitial colure*. The equator, both the colures, and all the other hour circles have nearly constant directions and fixed positions among the stars, just as the prime vertical and the meridian have with reference to the landscape at a particular place. The absolute position of the north pole, the celestial equator, and its colures among the stars can be determined

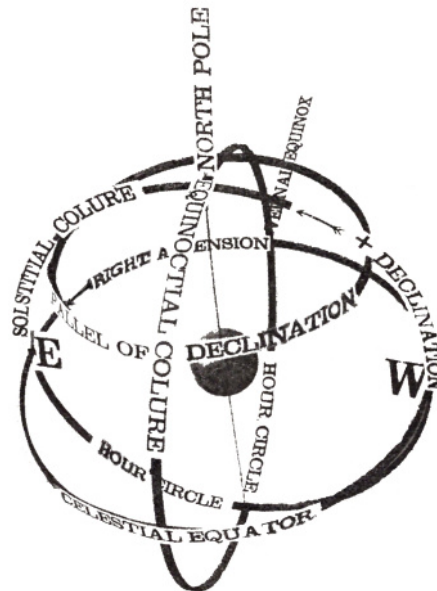

Chief Circles of Equator System (*B*)

at any time; and the astronomical processes by which this is done will be indicated farther on. Equator and colures should be concretely illustrated by three hoops secured at right angles, as in the horizon system.

Equator System glides over Horizon System.—It has already been seen that the stars themselves, by the diurnal motion, cross the planes and circles of the horizon system at a great variety of angles and velocities; evidently then, as the circles of the new system are practically fixed among the stars, the circles of this equator system must be imagined as all the time gliding over and across those of the horizon system. Spherical astronomy is a branch of the science dealing very largely with the relations of equator and horizon systems; and is mostly concerned with the angles that the circles of the horizon system make with those of the equator system. The problems arising are mostly solved by means of that branch of mathematics called spherical trigonometry, which is the science of ascertaining all the different parts of triangles described on the sphere, from certain parts that have been measured by instruments.

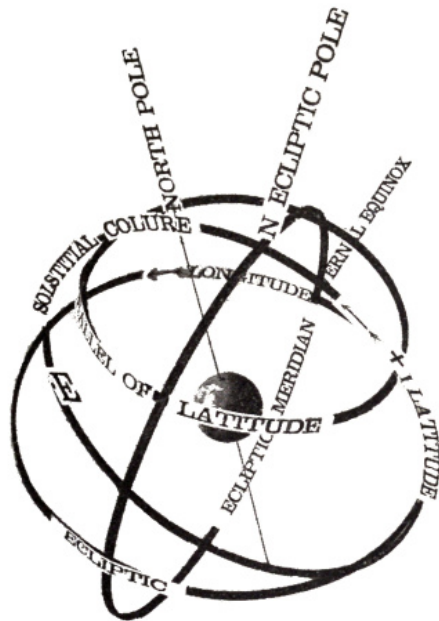

Chief Circles of Ecliptic System (C)

(C) **The Ecliptic System.**—

A third system of planes and circles of the celestial sphere, much used in astronomy, may best be defined and illustrated here, because it follows naturally and readily from the horizon system and the equator system. An idea of its relation to these other systems is easily obtained on recalling the way in which the equator system was derived from the horizon system—by pivoting the latter at the east and west points, and turning the skeleton horizon system about these pivots, until the zenith became the north pole of the heavens. Now in a precisely similar way, imagine the equator system pivoted at the two opposite points where equator and meridian cross. Then carry the north pole toward the west $23\frac{1}{2}^\circ$. The equator will

then have assumed a position inclined by an angle of $23\frac{1}{2}^\circ$ to its former position. It will, in short, have become the ecliptic; and in this novel relation nearly all the elements of the celestial sphere must again be defined.

A third system of hoops should be arranged as in the illustration. The ecliptic, as we shall see farther on, is the path in which the sun seems to travel completely round the sky once every year—a motion entirely distinct from that now under consideration.

Parallels of Latitude, Equinoxes and Solstices.—What was the north pole of the heavens becomes, in the ecliptic system, the north ecliptic pole. The equator itself, as has been said, is now the ecliptic. What were vertical circles in the horizon system, and hour circles in the equator system, are now *ecliptic meridians*. As almucantars became parallels of declination, so now parallels of declination become *parallels of celestial latitude*. Upper of the two pivotal points upon which equator turned about meridian is called the *Vernal Equinox*, or First of Aries; its opposite point, 180° away, the *Autumnal Equinox*. Or the equinoxes are, simply, two opposite points of the celestial sphere where equator and ecliptic cross each other. The word *equinox* signifies equality of day and night; and these points have this name because when the sun is exactly at either of them (in spring and autumn), it rises due east and sets due west. As the relations in the figure on the next page show, it is 12 hours above the horizon, making the day, and an equal interval of 12 hours below the horizon. Day and night are therefore equal in duration. Passing along the ecliptic eastward 90° from the vernal equinox, a point is reached that bears the name *Summer Solstice* (the sun's place in the latter part of June). Exactly opposite to it in the sky, or 90° beyond the autumnal equinox, is situated the *Winter Solstice* (the position of the sun just before Christmas).

Ecliptic System glides over Horizon System.—The ecliptic system of planes and circles maintains an almost invariable relation to the equator system and to the fixed stars. Therefore it also must glide over the seemingly stationary circles of the horizon system, in much the same manner that the planes and circles of the equator system do. In consequence, however, of the angle of $23\frac{1}{2}^\circ$ between equator and ecliptic the constantly varying relations of the ecliptic system to the horizon system will be more intricate than those of the equator system to the horizon system. But all these relations are readily understood, and may be completely solved by the processes of spherical astronomy.

The relation of equator to ecliptic, and their apparent daily motion through the sky, may be well illustrated by a plain model like the one here shown—two pasteboard disks cut together and secured to an ordinary thread-spool slipped on a lead pencil pointing upward to the pole, and twirled round in the direction of the arrows. In the first place, the north pole of the ecliptic, being $23\frac{1}{2}^\circ$ from the north pole of the heavens, is always distant $66\frac{1}{2}^\circ$ from the equator, and so seems

to move round the pole once every day, exactly as if it were a star in that position. Everywhere in the United States the north ecliptic pole is perpetually above the

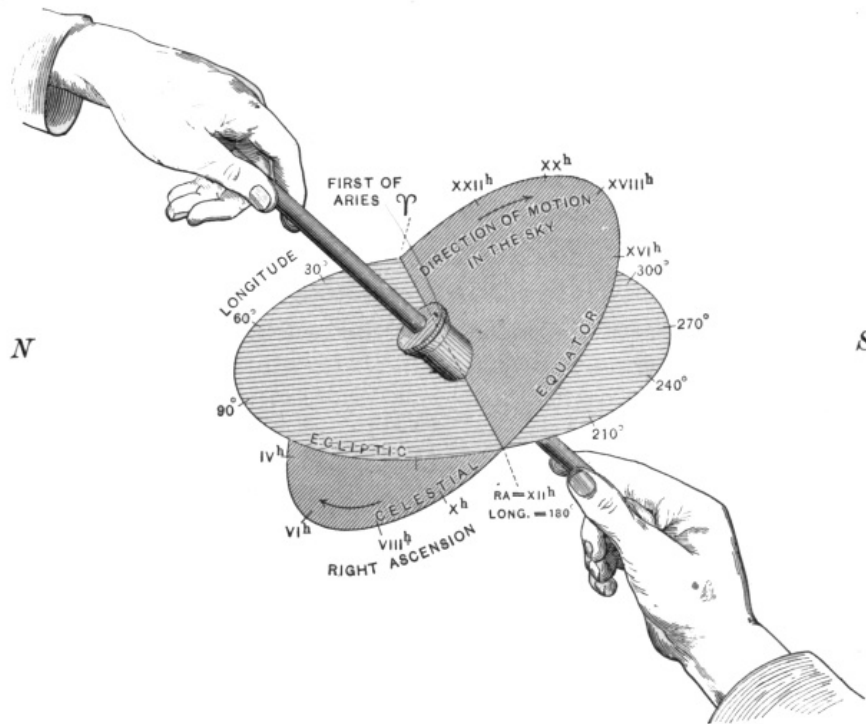

Model showing Apparent Motion of Equator and Ecliptic

horizon. The solstices being points $23\frac{1}{2}^\circ$ from the equator, the summer solstice north of it, and the winter solstice south, they also seem to move round the sky obliquely to the vertical circles of the horizon system. As the axis of revolution of the celestial sphere passes through the north and south poles of the equator system, the equator revolves round in its own plane, like a pulley on a shaft, and is always parallel to itself. Evidently, then, the ecliptic must partake of a wobbling motion because of its constant inclination of $23\frac{1}{2}^\circ$ to that seemingly stationary circle among the stars, the celestial equator. These three systems of circles—(A) *the horizon system*, (B) *the equator system*, (C) *the ecliptic system*—comprise all that are in general use by the astronomers of the present day.

Usual Astronomical Symbols.—There is a variety of symbols in common use for expressing in abbreviated form the names of sun, moon, and planets, their location in the sky, the signs of the zodiac, and so on. Some of them are frequently employed in other sciences with differing significations, but their astronomical meanings are as follows:—

☉ = the sun.	☿ = Mercury.
☾ = the moon.	♀ = Venus.
● = the new moon.	♁ = the earth.
○ = the full moon.	♂ = Mars.
♌ = conjunction, or the same in	♃ = Jupiter.
□ = quadrature, or differing 90° in	♄ = Saturn.
♍ = opposition, or differing 180° in	♅ = Uranus.
♊ = the ascending node.	♆ = Neptune.

} either longitude or
right ascension.

And for the signs of the zodiac (not the constellations of the same name), the following:—

(I) ♈ Aries	} Spring signs.	(VII) ♎ Libra	} Autumn signs.
(II) ♉ Taurus		(VIII) ♏ Scorpio	
(III) ♊ Gemini		(IX) ♐ Sagittarius	
(IV) ♋ Cancer	} Summer signs.	(X) ♑ Capricornus	} Winter signs.
(V) ♌ Leo		(XI) ♒ Aquarius	
(VI) ♍ Virgo		(XII) ♓ Pisces	

The explanation of technical terms used above will be given subsequently in appropriate paragraphs.

Expressing Large Numbers.—In astronomy there is frequent occasion to express very large numbers, because our earth is so small a part of the universe that terrestrial units often have to be multiplied over and over again, in order to represent celestial magnitudes. In this book, and in accordance with American usage generally, the French system of enumeration is used. From one million upward, it is as follows:—

1,000,000 = one million	} The usual or French system
1,000,000,000 = one billion	
1,000,000,000,000 = one trillion	
1,000,000,000,000,000 = one quadrillion	
etc. etc.	

through quintillions, sextillions, and so on; the Latin terms being employed, and each order being 1000 times that next preceding it. It is necessary, however, to note that in works on astronomy published in England, and now widely circulated in America, the English system of enumeration is always employed. The terms billion, trillion, quadrillion, and so on are used, but with entirely different signification: each is one million, instead of 1000, times the one next preceding

it. So that

$$\begin{aligned}
 1,000,000 &= \text{one million (English)} \\
 &= \text{one million (French)} \\
 1,000,000,000,000 &= \text{one billion (English)} \\
 &= \text{one trillion (French)} \\
 1,000,000,000,000,000,000 &= \text{one trillion (English)} \\
 &= \text{one quintillion (French)}
 \end{aligned}$$

Also, very large numbers are often expressed by an abridged or algebraic notation, in which there is no ambiguity.

$$\begin{aligned}
 \text{Thus, } 3 \times 10^9 &= 3,000,000,000 = \text{three billions (French)} \\
 6 \times 10^{12} &= 6,000,000,000,000 = \text{six billions (English)} \\
 &= \text{six trillions (French)}
 \end{aligned}$$

The small figure above the 10 is called an exponent, and indicates the number of times that 10 is taken as a multiplier.

East and West, North and South, in the Heavens.—Ordinary and restricted use of these terms, as adopted from geography, has already been defined: north and south state the direction of the true meridian; an east and west line is horizontal and at right angles to a north and south one. This use of these terms is wholly confined to the planes and circles of system (*A*), whose fundamental plane is the horizon. When, however, we pass to systems (*B*) and (*C*), the meaning of the terms *east* and *west*, *north* and *south*, changes also, to correspond with their fundamental planes. As related to these systems, then, we must define north, south, east, and west anew. *North* is the direction from any celestial body toward the north pole of the heavens; it is a constantly curving direction along the hour circle passing through that body. Similarly, *south* is the opposite direction, along the same hour circle, toward the south pole. Immediately underneath the pole, south, in system (*B*), means toward the north point of the horizon. *East* and *west* lie along equator and parallels of declination, in curving directions on the celestial sphere. When facing toward the south, east is the direction toward the left, or counter-clockwise around equator and parallels. The farther north or south a star is, the smaller its parallel, and the more rapid the curvature of the direction east and west from it. Also the terms *east* and *west*, *north* and *south*, are often used with reference to the planes and circles of system (*C*); north and south then lie along ecliptic meridians, and east and west are at right angles to these meridians, in the curving direction of ecliptic and parallels of celestial latitude. East is counter-clockwise, as in system (*B*), and north is toward the north pole of the ecliptic.

We are now prepared to consider the relations of these three systems to the work of the practical astronomer, to study the terminology of each, and to trace their points of geometric likeness philosophically.

Chapter III

The Philosophy of the Celestial Sphere

As the conception of the celestial sphere is now understood, we next give the reasons underlying the different systems already explained. These reasons are fundamental, having their origin in the principles of geometry itself. They have been known, and accepted since the days of Euclid (B.C. 280), who first gave a rational explanation of all those ordinary phenomena of the celestial sphere that the ancients were able to observe. Practical astronomy is the science of accurate ob-

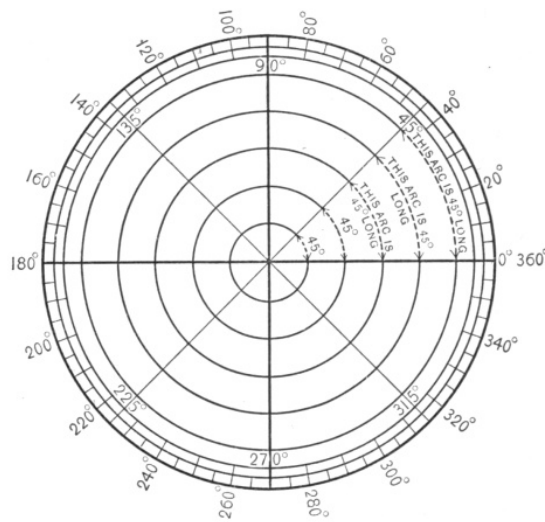

All Circles are divided into 360 Degrees

serva-tion and calculation of the positions of the heavenly bodies. In order that it should advance from a rudimentary beginning, the observations, as well as the mathematical processes by which they were calculated, had to be accurate. Precise observation was possible only when the heavenly bodies could be referred to some established point, or circle, or plane. Naturally the horizon was the first plane of reference, because the rising and setting of sun and moon and the brighter stars could be watched quite definitely. This fact explains the origin of the fundamental plane of the horizon system. Its related points, circles, and planes came naturally and necessarily

from the principles of geometry.

The Measure of Angles.—In astronomical measurements, circles of all possible sizes are dealt with; and every circle regardless of its size is divided into 360° . The degree is a unit of angular measure, not of length; and its value as described on a circular arc varies uniformly with the size of the circle. In concentric circles, for example, the number of degrees included between any two radii, as illustrated on page 41, is the same in all circles. Every degree is divided into $60'$, and every minute into $60''$. Do not confuse with the same symbols, often used to designate feet and inches.

Light moves in Straight Lines.—All astronomy is based on the truth of the proposition that, in a homogeneous medium like the ether, a weightless substance filling space, light moves in straight lines. The physicist demonstrates this from the wave theory of the motion of light.

The nature of a homogeneous medium may be illustrated by contrast with one that is not so. Look out of the window at objects seen just above the top of a heated radiator. They appear to be quivering and indistinct. We know that such objects—buildings, signs, trees—are really not distorted, as they seem to be; and we refer this temporary appearance to its true cause—the irregular expansion of the air surrounding the radiator. A portion of the medium, then, through which the light has passed, from the objects outside to the eye, is not homogeneous; and we know that if the radiator and the air round it were of the same temperature, there would be no such blending and scattering of the rays. The light passing over a heated chimney, the air above an asphalt walk on which the sun is shining, a flagstaff seemingly cut in two on a sunny day (when the eye is placed close to it and directed upward),—these and many other simple phenomena have a like origin. That violent twinkling of the stars which adds so much to the beauty of a winter night is due in large part to a vigorous commingling of warm air with cold, causing departure of the light-bearing medium from a perfectly homogeneous structure. On such nights the telescope cannot greatly assist the eye in astronomical observations.

Angles and Distances.—As light moves in straight lines, the angle which a body seems to fill, or subtend, is wholly dependent upon its distance from the eye. The more remote a given object is, the smaller the angle it subtends, and the nearer it is, the greater this angle. We do not always think of this when crossing a straight stretch of railway track, although we know that the rails are everywhere the same distance apart. But the camera, by projecting all objects on a plane surface regardless of their distance, brings out prominently the great difference in the angular breadth of the track near by and far away, so well shown in the picture. By trial we readily verify the following law:— *Angles subtended by a given object are inversely*

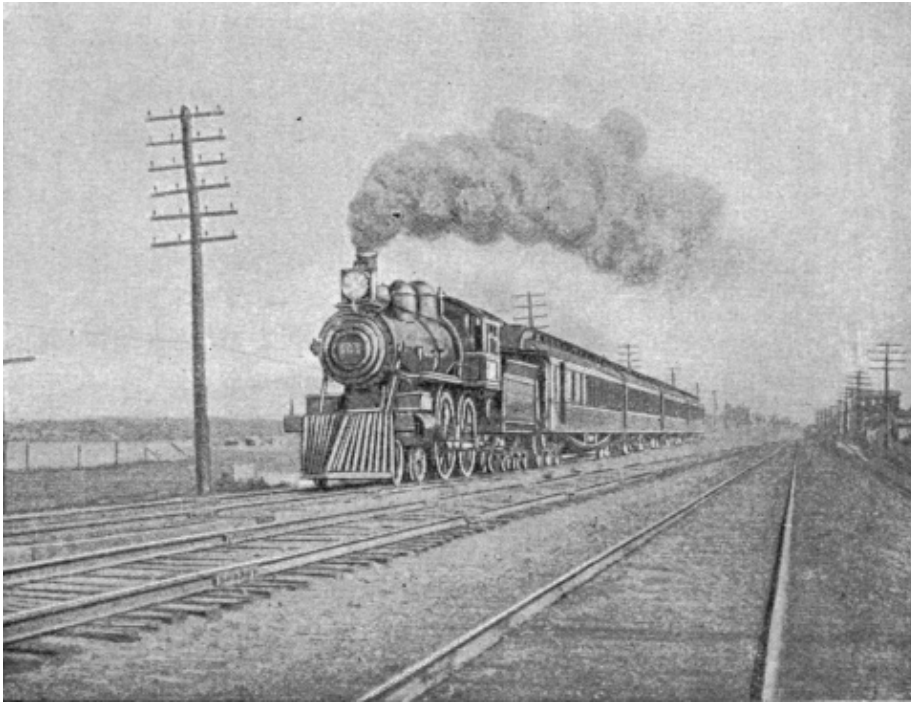

The Nearer the Track, the Broader it seems (Instantaneous Photograph by Trowbridge)

proportional to the distances at which it is placed. Consequently a number of bodies of various sizes—the silver dollar, the saucer, and the bicycle wheel, as shown in the illustration—may all subtend exactly the same angle, provided they are placed at suitable distances. Obviously, then, it is very indefinite to say that the moon looks as big as a dinner plate or a cart wheel, or anything else, unless at the same time it is stated how far from the eye the dinner plate or cart wheel or other object is supposed to be.

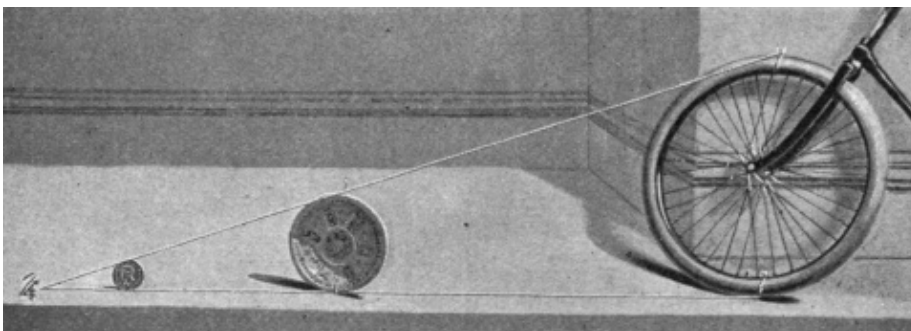

If Bodies fill the Same Angle, their Size is Proportional to their Distance

Moon and the Radian are Standards.—Observation shows that the moon actually subtends an angle of about one half a degree; and it has been demonstrated by geometry that a sphere whose distance is

$$\left. \begin{array}{l} 206,000 \\ 3,400 \\ 57 \end{array} \right\} \text{ times its diameter just fills an angle of } \left\{ \begin{array}{l} 1'' \\ 1' \\ 1^\circ \end{array} \right.$$

These numbers are obtained accurately as follows: Recalling the rule of mensuration concerning the circle, whose radius is r , its circumference, or $360^\circ = 2\pi r$, π being the familiar 3.14159, or $3\frac{1}{7}$. But as

$$\begin{aligned} 2\pi r &= 360^\circ = 21,600' = 1,296,000'' \\ r &= 57\frac{1}{3}^\circ = 3,438' = 206,265'' \end{aligned}$$

The angle r is a convenient unit of angular measure. As it is the arc measured on the circumference of any circle by bending the radius round it, this angle is often called the *radian*.

So that if the distance of an object from the eye is equal to 115 times its diameter, it will subtend the same angle that the moon does, and so will appear to be of the same size as the moon. The eye is often deceived in the distance and size of objects, generally placing them much nearer than they should be. This experiment is very easily tried: an ordinary copper cent, in order to fill the same angle as the moon should be placed at a distance of about seven feet; while a silver dollar should be nearly $14\frac{1}{2}$ feet away. The moon, then, always filling nearly the same angle of $\frac{1}{2}^\circ$, is an excellent standard of angular value; a small unit of arc measure. To express the apparent distance of a planet, for example, from a star alongside it, estimate how many times the moon's disk could be contained between the two objects; then half this number will express the distance roughly in degrees. Though the result may be somewhat erroneous, the principle is correct.

Altitude and Azimuth.—Altitude is the angular distance of a body above the horizon; and it is measured along the arc of the vertical circle passing through the body. Evidently the altitude of the zenith is 90° , and this is the maximum altitude possible. Oftentimes the term *zenith distance* is used; it is always equal to the difference between 90° and the altitude. But in order to fix the position of a body in the sky, it is not sufficient to give its altitude alone. That simply tells us that it is to be found somewhere in a particular small circle, or almucantar; but as it may be anywhere in that circle, a second element, called *azimuth*, becomes necessary. This tells us in what part of the almucantar the star is to be found. Azimuth is the

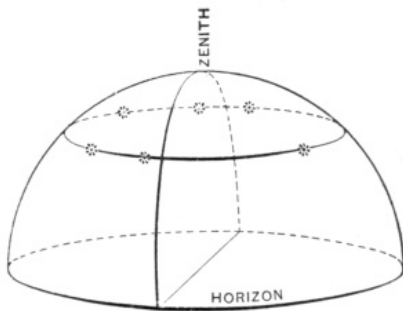

Stars of Equal Altitude

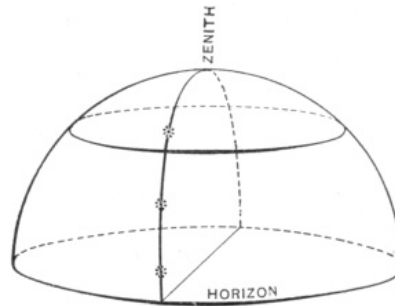

Stars of Equal Azimuth

angular distance of a body from the meridian; and it is measured along the horizon from the south point *clockwise* (that is, in the direction of motion of the hands of a clock), or through the points west, north, east, to the foot of the star's vertical circle. Azimuth, then, may evidently be as great as 360° . The position of a star in the northwest, and 40° from the zenith, would be recorded as follows: altitude 50° , azimuth 135° . One at 10° from the zenith, but in the southeast, would be: altitude 80° , azimuth 315° . The figures (on the current page) make it clear that many stars may have equal altitudes, although their azimuths all differ; while yet others, if located on the same vertical circle, may have equal azimuths, although their altitudes range between 0° and 90° .

A Simple Altazimuth Instrument.—This simple and readily built instrument is all that is needed to find altitudes and azimuths. Of course the measures will be made roughly, but the principles are perfectly correct. The illustration shows plainly the essentials of construction. From the corners of a firm board base about two feet square, let four braces converge, to hold an upright bearing, just below the azimuth circle. Through this bearing run an upright pole or straight piece of gas pipe, letting it rest in a socket on the base, in which it is free to turn round. A broom handle run through two holes bored in the middle of two opposite sides of a packing box will do very well, in default of anything better. Just above the azimuth circle attach to the upright axis a collar with a pointer equal in length to the radius of the azimuth circle. It is more convenient if this collar is fastened by a set screw. The circle is made of board, to which is glued a circle of paper or thin card, divided in degrees, beginning with 0° at S, and running through 90° at W, 180° at N, 270° at E, and so on. After dividing and numbering, the circle may be covered with two or three coats of thin shellac, in order to preserve it. Attach to the top of the vertical axis a second circle, the altitude circle, divided through its upper half, from 0° on each side up to 90° , or the zenith. Through the center of the altitude circle run



Model Sight

a horizontal bearing; it is better if large, say $\frac{1}{2}$ inch or more, because the index arm attached to it will then turn more evenly, and stop at any required position more sharply. In line with the index point and the center of the bearing, attach two sights near the ends of the arm. Essentially the altazimuth instrument is then complete. Sights for use upon stars with the naked eye should be of about this size and construction: The aperture of about $\frac{1}{5}$ inch does not diminish the star's light, and the small cross threads or wires give the means of fairly accurate observation.

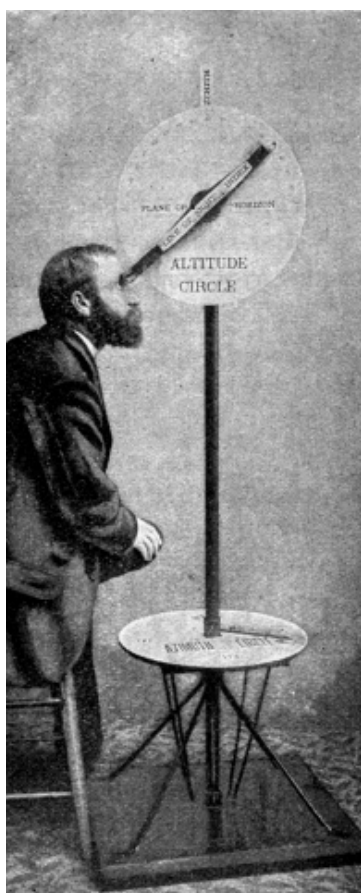

Model of the Altazimuth

Use of the Altazimuth.—To use it, level the azimuth circle, and bring the line through N and S to coincide with the meridian, already found. See that the line of zeros of the altitude circle is, as nearly as may be, at right angles to the vertical axis. Point the sights in the line of the meridian, and while looking northward, clamp the azimuth pointer exactly at 180° , by means of its collar. The instrument is then ready for use; and on pointing it at any celestial body, its altitude and azimuth at the time of observation may be read directly at the ends of the pointers of the two circles. If the instrument has been made and adjusted with even moderate care, its readings will pretty surely be within one degree of the truth; and for practicing the eye in roughly estimating altitudes and azimuths at a glance, nothing could be better. Also take the altitude of the sun and stars when on the meridian and the prime vertical. To observe the sun most conveniently, let its rays pass through a pin hole at the upper end of the index, or pointer, and fall upon a card at the lower end with a cross marked upon it; care being taken that the line of the pin hole and the cross is parallel to the line of sights.

Origin of the Equator System.—The motion of the celestial sphere is continually changing the altitude and azimuth of a star. Consequently the horizon and its connected circles are a very inconvenient system of noting the positions of stars with reference to each other; even the ancients had observed that these bodies did not seem to move at all among themselves from age to age. It was natural and necessary therefore to devise a system

of coördinates, as it is called, in which the stars should have their positions fixed, or nearly so. From the time of Euclid, at least, a philosopher here and there was satisfied that the earth is round, that it turns on its axis, and that the axis points in a nearly constant direction among the stars. Readily enough, then, arose the second, or equator system of elements of the celestial sphere; the north end of the earth's axis prolonged to the stars gave the primal point of the system—the north pole of the heavens. Everywhere 90° from it is the great circle girdling the sky, in the plane of the earth's equator extended, and called therefrom the celestial equator.

Declination.—This plane or circle (often termed the *equinoctial*, but generally called the *equator* simply), becomes the fundamental reference plane of the equator system (*B*). It sustains exactly the relation to the equator system that the horizon has to the horizon system (*A*). And, similarly, two terms are necessary to fix the position of a star relatively to the equator. First, the declination, which is the counterpart of altitude in system (*A*). The *declination* of a body is its angular distance from the equator; and it is measured north or south from that plane, along the hour circle passing through the body. If the star is north of the equator, it is said to be in *north* or plus declination; if south, then in minus or *south* declination. Evidently, stars north of the equator may have any possible declination up to plus 90° , the position of the north pole; and stars south of the equator cannot exceed a declination of minus 90° . The symbol for declination is *decl*, or simply δ (the small Greek letter *delta*). Sometimes the term *north polar distance* is substituted for declination; and it is counted along the star's hour circle southward, from the north pole, right through the equator if necessary. North polar distance cannot exceed 180° , the position of the south pole of the heavens. For example, the north polar distance of a star in declination $+20^\circ$ is 70° ; and if the declination is -22° , the north polar distance is 112° .

Right Ascension.—Recalling again the terms and circles of the horizon system, it is apparent that declination alone cannot fix a star's position on the celestial sphere any more than mere altitude can. It would be like trying to tell exactly where a place on the earth is by giving its latitude only; the longitude, or angular distance on the earth's equator from a prime meridian must be given also. So the companion term for declination is *right ascension*; and it is the counterpart of azimuth in the horizon system (*A*). But note two points of difference. The right ascension of a body is its angular distance from the vernal equinox (a point in the equator whose definition has already been given on page 33). Right ascension is measured *eastward*, or counter-clockwise, along the equator, to the hour circle passing through the body. It may be measured all the way round the heavens, and

therefore may be as great as 360° . But as a matter of convenience purely, right ascension is generally denoted in *hours*, not degrees (figure on page 34). As 24 hours comprise the entire round of the sky, and 360° do the same, one may be substituted for the other. Each hour, then, will comprise as many degrees as 24 is contained times in 360; that is, 15. Also hours are divided into minutes and minutes sub-divided into seconds of time, just as degrees are, into minutes and seconds of arc. So that we have:—

$$\left. \begin{array}{l} 1 \text{ h.} = 15^\circ \\ 1 \text{ m.} = 15' \\ 1 \text{ s.} = 15'' \end{array} \right\} \text{ and } \left\{ \begin{array}{l} 1^\circ = 4 \text{ m.} \\ 1' = 4 \text{ s.} \\ 1'' = 0.0667 \text{ s.} \end{array} \right.$$

These are relations constantly required in astronomy. Usual symbols for right ascension are R. A., or \mathcal{R} , or simply α (the small Greek letter *alpha*), standing for *ascensio recta*. The figures make it clear that stars may have equal right ascension, although their declinations differ widely, and *vice versa*.

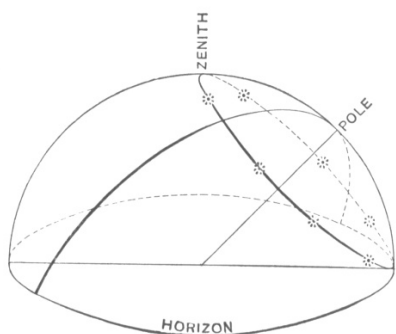

Stars of Equal Declination

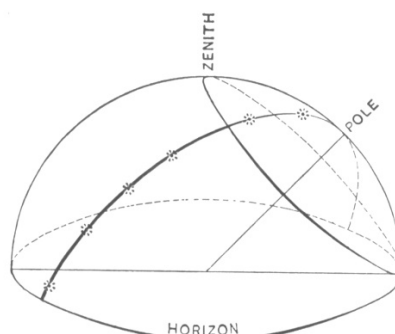

Stars of Equal Right Ascension

The Equatorial Telescope.—Just as the altazimuth is an instrument whose motions correspond to the horizon system, so the motions of the equatorial telescope correspond to the equator system. This instrument, generally called merely the *equatorial*, is a form of mounting which enables a star to be followed in its diurnal motion by turning the telescope on only one axis.

This axis is always parallel to the axis of the earth, and is called the *polar axis*. As it must point toward the north pole of the heavens, the polar axis will stand at about the angle shown in the picture, for all places in the United States. The simplest way to understand an equatorial is to regard it as an altazimuth with its principal or vertical axis tilted northward until it points to the pole. The azimuth

circle then becomes the *hour circle* of the equatorial; the horizontal axis becomes the *declination axis* of the equatorial; and the circle attached to it is called the *declination circle* (the counterpart of the altitude circle in the al-tazimuth). At one end of the declination axis and at right angles to it the telescope tube is attached, as shown. The model in the illustration may be constructed by any clever boy. The axes are pine rods running through wooden bearings, and it is well to soak them with hot paraffin. The telescope tube is a large pasteboard roll.



Model of the Equatorial Telescope

How to adjust and use this Equatorial.—

Having already found direction of the meridian, the polar axis must be

brought into its plane, and the north end of this axis elevated to an angle equal to the latitude. This can be taken accurately enough from any map of the United States. Draw a line on the outside of the bearing of the polar axis parallel to the axis itself; and across this line, at an angle equal to the latitude (laid off with a protractor), draw another line which will be nearly horizontal. The adjustment is completed by means of an ordinary artisan's level, placed alongside this second line. Take out the object glass and eyepiece, and point the telescope at the zenith, as nearly as the eye can judge. Then hang a plumb-line through the tube, suspending it from the center of the upper end, and continuing to adjust the tube till the line hangs centrally through it. While the tube remains fixed in this position, set the hour circle to read zero, and the declination circle to a number of degrees equal to the latitude. The model equatorial is then ready to use. Declinations can be read from the declination circle directly, bringing any heavenly body into the center of the field of view. And right ascensions can be found when the hour angle of the vernal equinox is known. A method of finding

this will be given in the next chapter (p. 59). Distinguish between the double and differing significations of the term *hour circle*: when the equatorial is adjusted, *its* hour circle, being parallel to the terrestrial equator, is therefore at right angles to *the* hour circles of the celestial sphere.

Telescopes as mounted in Observatories.—Nearly all the telescopes in observatories are mounted equatorially. The cardinal principles of these mountings are similar to those of the model already given. An equatorial telescope is

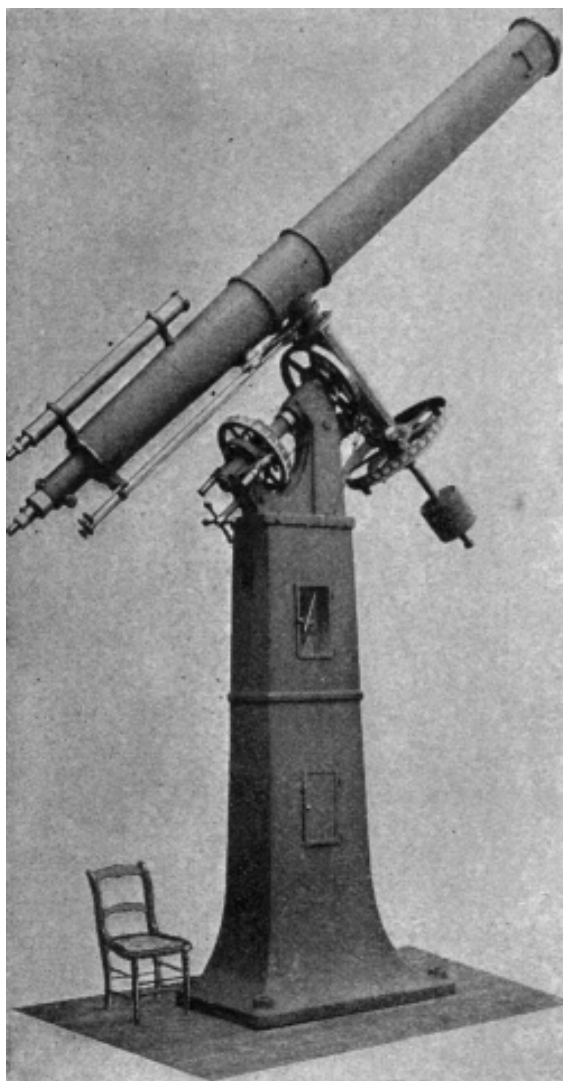

10-Inch Equatorial (Warner & Swasey)

shown in the illustration opposite. The small tube at the lower end of the large one and parallel to it is a short telescope called the 'finder,' because it has a large field of view, and is used as a convenience in finding objects and bringing the large telescope to bear upon them. Iron piers, nearly cylindrical in the best mountings, but often rectangular, are now generally employed in supporting the axes of telescopes. An hour circle is sometimes attached to the upper end of the polar axis, as shown; and geared to the outside of this circle is a screw or worm, turned by clockwork (underneath in the middle of the pier). The clock is so regulated as to turn the polar axis once completely round from east toward west in the same period that the earth turns once completely round on its

axis from west toward east. When a star has been placed in the field of view, and the axis clamped, the clock maintains it there without readjusting, as long

as the observer may care to watch. Each axis of a large equatorial is provided with a mechanical convenience called a 'slow motion,' one for right ascension and one for declination. These devices are operated by handles (at the right of the tube), which can be turned by the observer while looking through the eyepiece; and they enable him to move an object slowly from one part of the field of view to another, as required.

Celestial Latitude.—The third system of coördinates of the celestial sphere—(*C*) the ecliptic system—is founded on the path which the sun seems to travel among the stars, going once around the entire heavens every year. In fact, the ecliptic is usually defined as the apparent annual path Of the sun's center. This path is a great circle of the celestial sphere. And as it always remains constant in position, relatively to the fixed stars, its convenience as a fundamental plane of reference is easy to see. The name *ecliptic* is applied, because eclipses of sun and moon are possible only when our satellite is in or near this path. Upon the ecliptic as a fundamental plane is based a system of coördinates, precisely as in the equator system (*B*). Celestial *latitude*, or a star's latitude merely, is its angular distance from the ecliptic; and it is measured north or south from that plane, along the ecliptic meridian passing through the star. Latitude is the counterpart of altitude in the horizon system, and of declination in the equator system. If the star is north of the ecliptic, it is said to be in *north* or *plus* latitude; if south, then in *minus* or *south* latitude. No star can exceed $\pm 90^\circ$ in latitude. As the center of the sun travels almost exactly along the ecliptic, year in and year out, its latitude is always practically zero. The symbol for latitude is β (the small Greek letter *beta*). Sometimes the term *ecliptic north polar distance* is convenient; it is measured southward along the ecliptic meridian passing through the star. It is independent of the ecliptic itself, and may have any value from 0° to 180° , according to the star's place in the heavens. A star whose

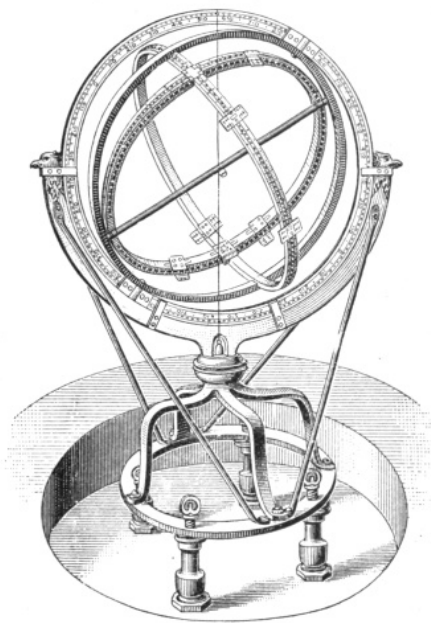

The Ecliptic Astrolabe

latitude is -38° is located in ecliptic north polar distance 128° .

Celestial Longitude.—Celestial longitude is the term used to designate the angular distance of a star from the vernal equinox, measured eastward along the ecliptic to that ecliptic meridian which passes through the star. It is counted in degrees from 0° all the way round the heavens to 360° if necessary. By drawing a figure similar to that on page 44, and replacing the celestial pole by the pole of the ecliptic, it becomes clear that all stars on any parallel of latitude have the same latitude, no matter what their longitudes may be; and that all stars on any half meridian of longitude included between the ecliptic poles must have the same longitude, although their latitudes may differ widely. As the equinoxes mark the intersection of equator and ecliptic, they must both be in equator and ecliptic alike. On the ecliptic, and midway between the two equinoxes, are two points, called the *solstices*. Hence the name of the hour circle, or colure which passes through them—the solstitial colure. At the times of the solstices, the sun's declination remains for a few days very nearly its maximum, or $23\frac{1}{2}^\circ$. It was this apparent *standing still* of the sun with reference to the equator (north of the equator in summer, and south of it in winter) which gave rise to the name *solstice*.

In observing the positions of the heavenly bodies before the invention of clocks, the ancient astronomers, particularly Tycho Brahe, used a type of astronomical instrument called the ecliptic *astrolabe*, a kind of armillary sphere, in which the longitude and latitude of a star could be read at once from the circles. But instruments of this character are now entirely out of date, only a few being preserved in astronomical museums, the principal one of which is at the Paris Observatory. The astronomers of to-day never determine the longitude and latitude of a body by direct observation, but always by mathematical calculation from the right ascension and declination; because the longitude and latitude can be obtained in this way with the highest accuracy.

Summary and Correlation of Terms.—Correlation of the three systems just described, and of the terms used in connection with each, is now in order. In the first column is the nomenclature of system (*A*), with the horizon for the reference plane; in the second column, the terminology of system (*B*), in which the celestial equator is the fundamental plane; and in the third column are found the corresponding points, planes, and elements referred to the ecliptic system (*C*):—

THE PHILOSOPHY OF THE CELESTIAL SPHERE

IN THE HORIZON SYSTEM (<i>A</i>)	BECOMES IN THE EQUATOR SYSTEM (<i>B</i>)	BECOMES IN THE ECLIPTIC SYSTEM (<i>C</i>)
Horizon	Celestial equator	Ecliptic
Vertical circle	Hour circle	Ecliptic meridian
Zenith	North pole	N. pole of the ecliptic
Meridian	Equinoctial colure	Ecliptic meridian
Prime vertical	Solstitial colure	Solstitial colure
Azimuth (<i>negative</i>)	Right ascension	Celestial longitude
Altitude	Declination (N.)	Celestial latitude (N.)

These three systems of planes and circles of the celestial sphere comprise all those used by astronomers, except in the very advanced investigations of mathematical and stellar astronomy.

Chapter IV

The Stars in their Courses

The fundamental framework for our knowledge of the heavens may now be regarded as complete. We next consider its relations from different points of view on earth, at first filling in details of the stars as necessary points of reference in the sky.

The Constellations.—In a very early age of the world, the surface of the celestial sphere was imagined to be covered by figures, human and other, connecting different stars and groups of stars together in a fashion sometimes clear, though usually grotesque. The groups of stars making up these imaginary figures in different parts of the sky are called *constellations*. Eudoxus (B.C. 370) borrowed from Egyptian astronomers the conception of the celestial sphere, bringing it to Greece, and first outlining upon it the ecliptic and equator with the more prominent constellations. About 60 are well recognized, although the whole number is nearly twice as great. This ancient, and in most respects inconvenient, method of naming and designating the stars is retained to the present day. In general, small letters of the Greek alphabet are used to indicate the more prominent stars of a constellation, α representing its brightest star, β the next, γ the third, and so on. The Greek letter is followed by the Latin genitive of name of constellation; thus α Orionis is the most conspicuous star in the constellation of Orion, γ Virginis is the third star in order of brightness in Virgo, and so on. Following are these letters, written either as symbols, or as the English names of these symbols:—

α	Alpha	η	Eta	ν	Nu	τ	Tau
β	Beta	θ	Theta	ξ	Xi	υ	Upsi'lon
γ	Gamma	ι	Iota	\omicron	Omi'cron	ϕ	Phi
δ	Delta	κ	Kappa	π	Pi	χ	Chi
ϵ	Epsi'lon	λ	Lambda	ρ	Rho	ψ	Psi
ζ	Zeta	μ	Mu	σ	Sigma	ω	Omeg'a

A few constellations embrace more than 24 stars requiring especial designation, and for these the letters of the Latin alphabet are employed; and if these are exhausted, then ordinary Arabic numerals follow. Thus stars may be designated as F Tauri, 31 Aquarii, and so on. About 100 conspicuous stars have other and proper names, mostly Arabic in origin: thus Vega is but another name for α Lyræ, Aldebaran for α Tauri, Merak for β Ursæ Majoris. The lucid stars, or stars visible to the naked eye, are divided into six classes, called *magnitudes*. Of the first magnitude are the 20 brightest stars of the firmament, and the number increases roughly in geometric proportion. Of the sixth magnitude are those just visible to the naked eye on clear, moonless nights. On page 369 are given the names of the brightest stars; and from Figures 4.2 and 4.4 can be found their location in the sky.

Convenient Maps of the Stars.—On the star maps given as Figures 4.2 and 4.4 are shown all the brighter stars ever visible in the United States. In each figure the lower or dark chart is a faithful transcript of the ‘unlanterned sky,’ and the upper map is merely a key to the lower. Notwithstanding their small scale, the asterisms are readily traceable from the dark charts, and the names of especial stars and constellations are then quickly identified by means of the keys. To connect the charts with the sky, conceive the celestial sphere reduced to the size of a baseball. At its north pole place the center of the circular map (Figure 4.2); and imagine the rectangular map (Figure 4.4) as wrapped round the middle of the ball, the central horizontal line of the chart coinciding with the equator of the ball. Just as the maps, if actually applied to a baseball, would not make a perfect cover for it without cutting and fitting, so there will be found some distortion in comparing the maps with the actual sky, especially near the top and bottom of the oblong chart. Whatever the season of the year, the charts are easy to compare with the sky, by remembering that (for 8 P.M.) Figure 4.2 must be held due north, and the book turned so that the month of observation appears at the top of the round chart, or vertically above Polaris, which is near the center of the map. The asterisms immediately adjacent to the name of the month will then be found at or near the observer’s zenith. Similarly with Figure 4.4: face due south, and at 8 P.M. stars directly under the month will be found near the zenith, and the oblong chart will overlap the circumpolar one about half an inch, or 30° . At the middle of the rectangular chart, under the appropriate month, are found the stars upon the celestial equator; and at the bottom of the map, the constellations faintly visible near the south horizon. Every vertical line on this chart coincides with the observer’s meridian at eight o’clock in the evening of the month named at the top. If the hour of observation is other than this, allow two hours for each month; for example, at 10 P.M. in November the stars underneath ‘DECEMBER’ will be found on the meridian.



KEY TO CHART OF NORTH POLAR HEAVENS (Shows how the stars appear, in relation to North Horizon, at 8 P.M. during the month held at the top.)



The North Polar Heavens

Likewise Figure 4.4 must be turned counter-clockwise with the lapse of time, at the rate of one month for two hours. If, for example, we desire to inspect the north polar heavens at 6 P.M. in December, we should hold the book upright, with November at the top.

Constellations of Circumpolar Chart.—Most notable is Ursa Major, the Great Bear, near the bottom (Figure 4.2). Its seven bright stars are familiarly known in America as the ‘Dipper,’ and in England as ‘Charles’s Wain,’ or wagon. Of these, the pair farthest from the handle are called ‘the Pointers,’ because a line drawn through them points toward the pole star, as the arrow shows. The Pointers are five degrees apart, and, being nearly always above the horizon, are a convenient measure of large angular distances. At the bend of the dipper handle is Mizar, and very near it a faint star, Alcor. When Mizar is exactly above or below Polaris, both stars are on the true meridian, and therefore indicate true north (page 101). The Pointers readily show Polaris, a second magnitude star (near the center of Figure 4.2). No star of equal brightness is nearer to it than the Pointers. From Polaris a line of small stars curves toward the handle of the Dipper, meeting the upper one of a pair of the third magnitude. This pair, with another farther on and parallel to it, form the ‘Little Dipper,’ Polaris being the end of its handle. The group is Ursa Minor. Opposite the handle of the great Dipper, and at about the same distance from Polaris, are five rather bright stars forming a flattened letter W. They are the principal stars of Cassiopeia.

Learning the Constellations.—With these slender foundations, once well and surely laid, familiarity with the northern constellations is soon acquired. It is excellent practice to draw the constellations from memory, and then compare the drawings with the actual sky. An hour’s watching, early in a September evening, will show that the Dipper is descending toward the northwest horizon, and Cassiopeia rising from the northeast. Nearly overhead is Vega. Capella, the large star near the right of Figure 4.2, will soon begin to twinkle low down in the northeast. Familiarity with the northern constellations is the prime essential, and they should be committed, independently of their relations to the horizon at a particular time, for at some time of the year all these constellations will appear inverted. Make acquaintance with them so thorough that each is recognized at a glance, no matter what its relation to the horizon may be.

Constellations of the Equatorial Girdle.—All the more important ones are named on the key to Figure 4.4. None is more striking than Orion, whose brilliance is the glory of our winter nights. Hard by is Sirius, brightest of all the stars of the firmament, which, with Procyon and the two principal

stars of Orion, forms a huge diamond, intersected by the solstitial colure, or VIth hour circle. Eastward from Procyon to Regulus may be formed a vast triangle; and still farther east, with Spica and Arcturus, one vaster still. By means of similar arbitrarily chosen figures, as in the key, all the constellations may readily be memorized, one after another, until the cycle of the seasons is complete. Also the ecliptic's sinuous course is easy to trace, from Aries round to Aries again.

Helps to Constellation Study.—Perhaps the easiest to use and in every way the most convenient is the planisphere. By its aid all the visible constellations may be expeditiously traced, the times of rising and setting of the sun, planets, and stars found, and a variety of simple problems neatly solved. Another excellent help in learning the constellations is the astral lantern devised by the late James Freeman Clarke. The front side of the box is provided with a ground glass slide. In front of and into the grooves of this may be slipped cards, figured with the different asterisms, as indicated in the illustration. But the peculiar effectiveness of the lantern consists in the minute punctures through the cards, the size of each puncture being graduated according to the magnitude of the star. Bailey's astral lantern is a similar device for a like purpose. Also a celestial globe is sometimes used in learning the constellations, but the process is attended with much difficulty because the constellations are all reversed on the surface of the globe, and the observer must imagine himself at the center of it and looking outward. Plainly marked upon the globe are many of the circles of System (*B*),—equator, colures, and parallels of declination. Also usually the ecliptic. See illustration on page 62. The globe turns round in bearings at the poles, fastened to a heavy meridian ring *M M* which can be slipped round in its own plane through slots in the horizon circle *H*. The process of setting the globe to correspond to the aspect of the heavens at any time is called rectifying the globe. Bring the meridian ring into the plane of the meridian, and elevate the north pole to an angle equal to the latitude. On pages 62, 62, and 64 are globes rectified to the latitudes indicated.

Farther Helps.—If complete knowledge of the firmament is desired, a good star atlas is the first essential, such as have been prepared with great care by Proctor, and Klein, and Sir Robert Ball, and Upton. These handy volumes quickly give a familiarity with the nightly sky which hurries the learner on to the possession of a telescope. By a list or catalogue of celestial objects may be found any celestial body, though not mapped in its true position on the charts, if an equatorial mounting like the model illustrated on page 45 is constructed. A mere pointer in place of the tube will make it into that convenient instrument called Rogers's 'star finder.' The simplest of telescopes must not be despised for a beginning. *Astronomy with an Opera Glass*, by Serviss, shows admirably what may be done with the slightest optical aid. When a 3-inch telescope becomes available, there is a multitude of appropriate handbooks, none better than

KEY TO CHART OF EQUATORIAL GIRDLER OF THE STARS (The stars under the name of the month are on the meridian (looking south) at 8 P.M.)

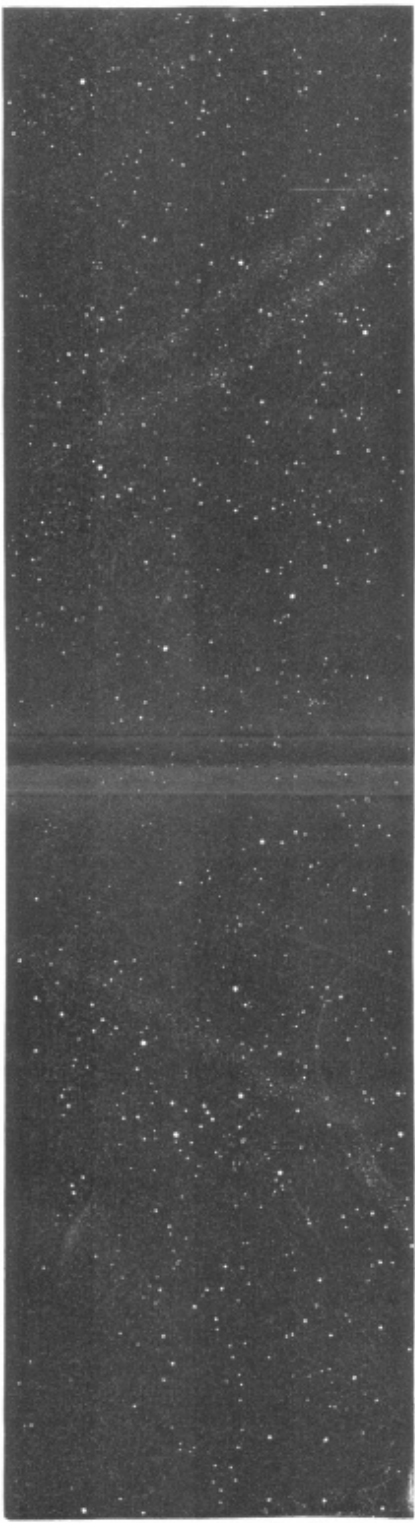
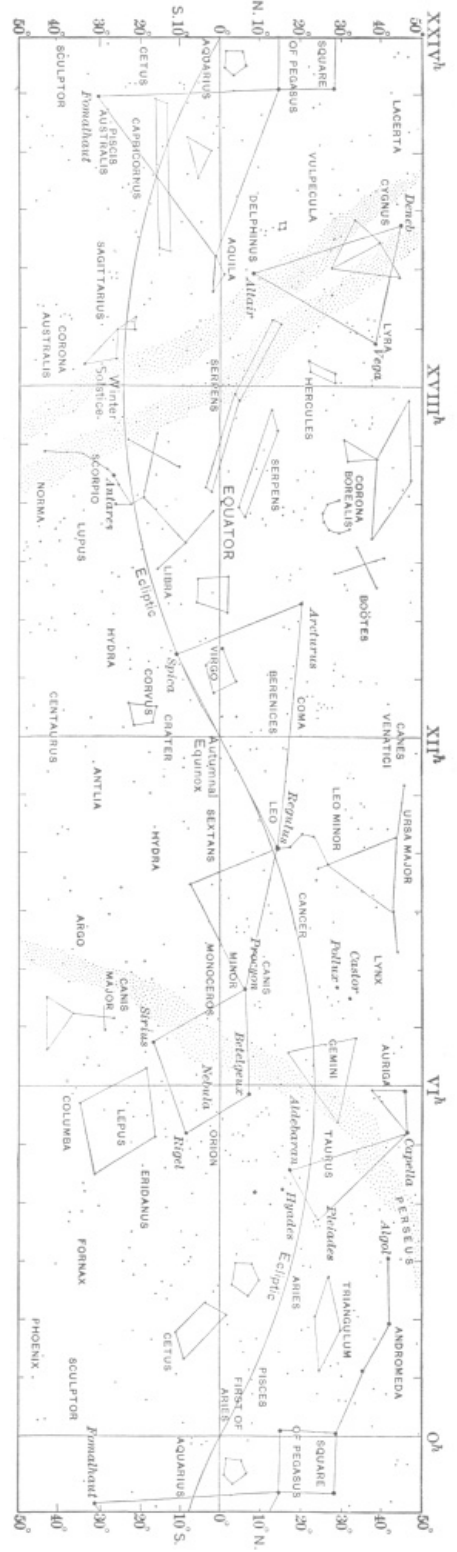
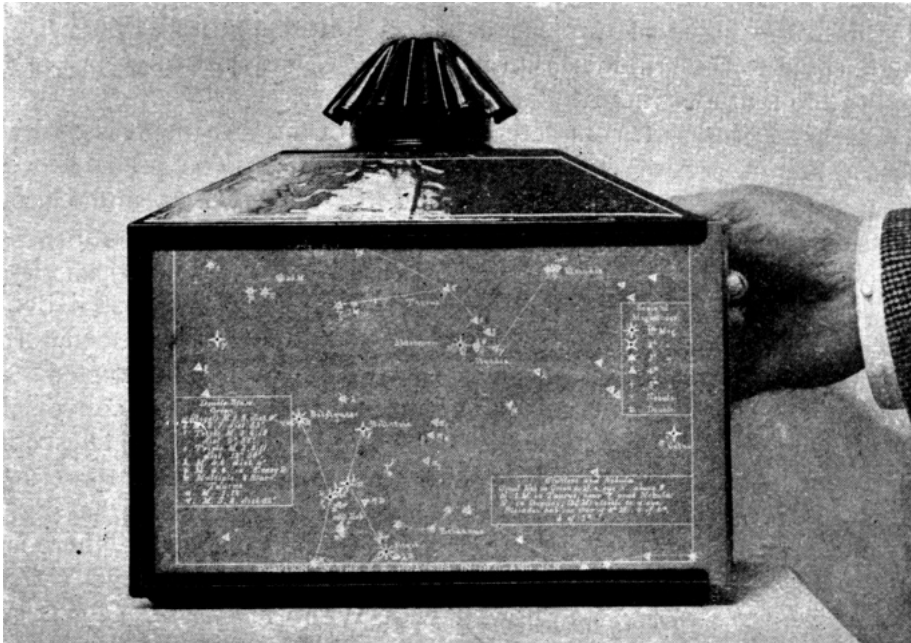

PLATE IV.—THE EQUATORIAL GIRDLER OF THE STARS



Astral Lantern for tracing Constellations

Proctor's *Half Hours with the Stars*. Follow it with Webb's *Celestial Objects for Common Telescopes*, a veritable storehouse of celestial good things.

The Zodiac.—Imagine parallels of celestial latitude as drawn on either side of the ecliptic, at a distance of 8° from it; this belt or zone of the sky, 16° in width, is called the *zodiac*. Neither the moon nor any one of the bright planets can ever travel outside this belt. About 2000 years ago both ecliptic and zodiac were divided by Hipparchus, an early Greek astronomer, into twelve equal parts, each 30° in length, called the signs of the zodiac. The names of the constellations which then corresponded to them have already been given in their true order on page 35; but the lapse of time has gradually destroyed this coincidence, as will be explained at the end of Chapter VI. In the figure the horizontal ellipse represents the ecliptic, and at the beginning of each sign is marked its appropriate symbol. *E* is the pole of the ecliptic, *P* the north celestial pole, and the inclined ellipse shows where the equator girdles the celestial sphere. The signs of the ecliptic girdle have from time immemorial been employed to symbolize the months and the round of seasons; and a type of ancient Arabian zodiac is embossed on the cover of this book, reproduced from Flammarion. The signs of the zodiac are discarded in the accurate astronomy of to-day; and the positions of the heavenly bodies are now designated with reference to the

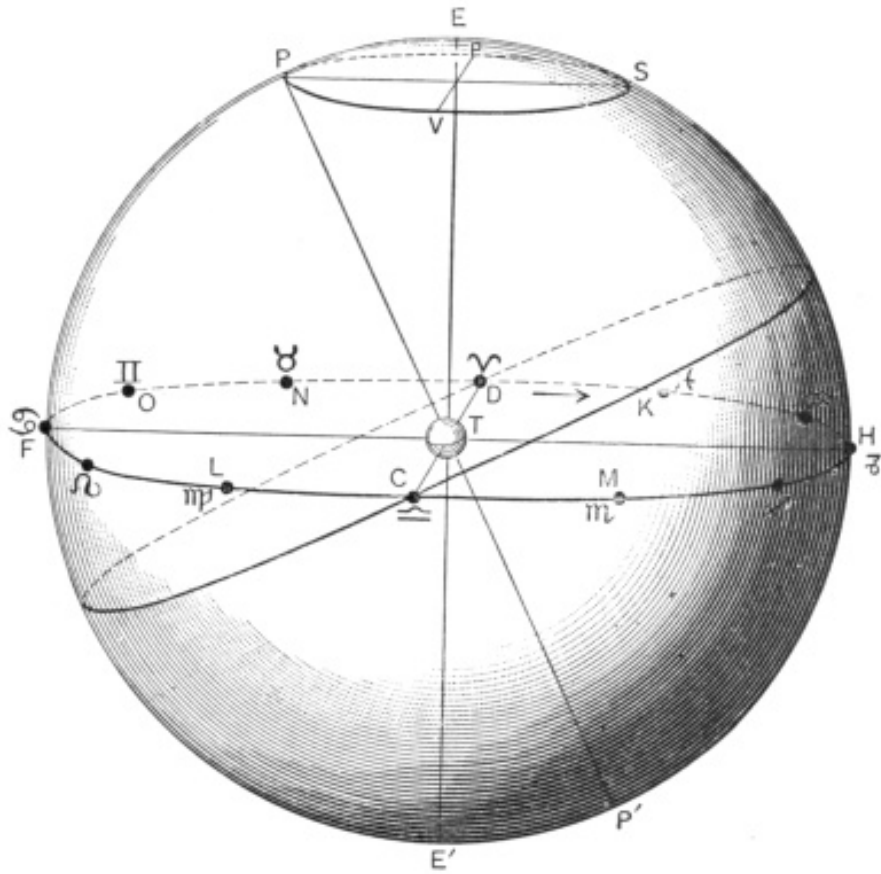

Celestial Sphere and Signs of the Zodiac

ecliptic, not by the sign in which they fall, but by their celestial longitude. Conventionalized symbols of the signs of the zodiac, and the position of the zero point of each sign, are shown on the sphere on this page, beginning with 0° of Aries at *D*, and proceeding counter-clockwise as the sun moves, or contrary to the direction the arrow.

How to locate the Equinoxes among the Stars.—On the earth the longitude of places is reckoned from *prime meridians* passing through well-known places of national importance. But the equinoctial colure, the prime meridian of the heavens, is a purely imaginary circle, and is not marked in any such significant manner, as we should naturally expect, by means of brilliant stars. It is, however, important to be able to point out the equinoxes roughly among the stars. The vernal equinox is above the horizon, at convenient evening hours in autumn and winter. Its position may be found by prolonging a line (hour circle) from Polaris southward

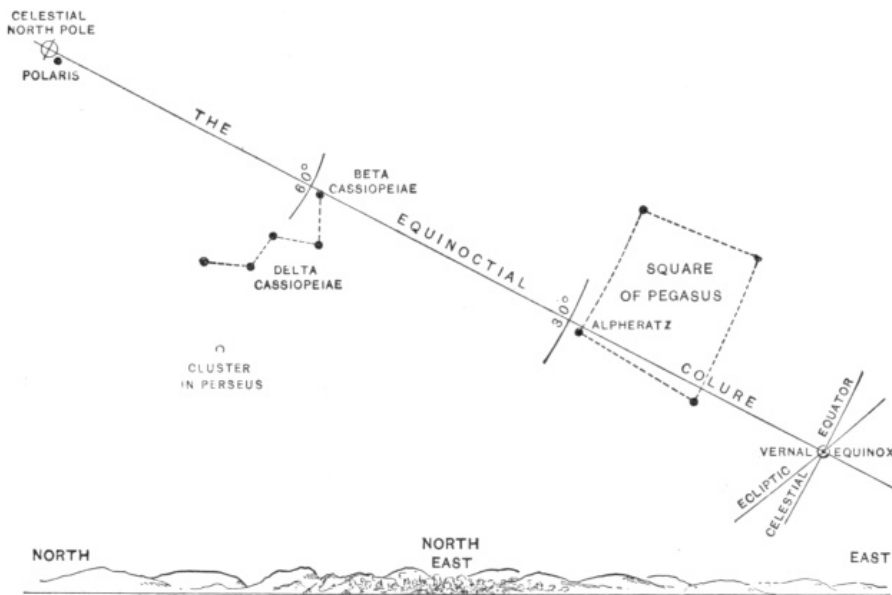

How to locate the Vernal Equinox

through Beta Cassiopeia, as in the above illustration.

This will be about 30° in length. Thirty degrees farther in the same direction will be found the star Alpheratz (Alpha Andromedæ), equal in brightness with Beta Cassiopeia. Then as the equinox is a point in the equator, and the equator is 90° from the pole, we must go still farther south 30° beyond Alpheratz; and in this almost starless region the *vernal equinox* is at present found. It will hardly move from this point appreciably to naked-eye observation during a hundred years. This quadrant of an hour circle (from Polaris to the vernal equinox) will be very nearly a quadrant of the equinoctial colure also. Because Alpheratz and Beta Cassiopeia are very near it, their right ascension is about 0 hours. Through spring and summer the autumnal equinox will be above the horizon at convenient evening hours. This equinox, like the other, has no bright star near it; roughly it is about $\frac{2}{5}$ of the way from Spica (Alpha Virginis) westward toward Regulus (Alpha Leonis), as shown in the following diagram.

How to locate the Ecliptic (approximately) at Any Time.—It will add much to the student's interest in these purely imaginary circles of the sky if he is able to locate them (even approximately) at any time of the day or night. Only two points in the sky are necessary. By day the sun is a help, because his center is one point in the ecliptic. If the moon is above the horizon, that will be another point, approximately. Then imagine a plane passed through sun and moon and the point of observation, and that will

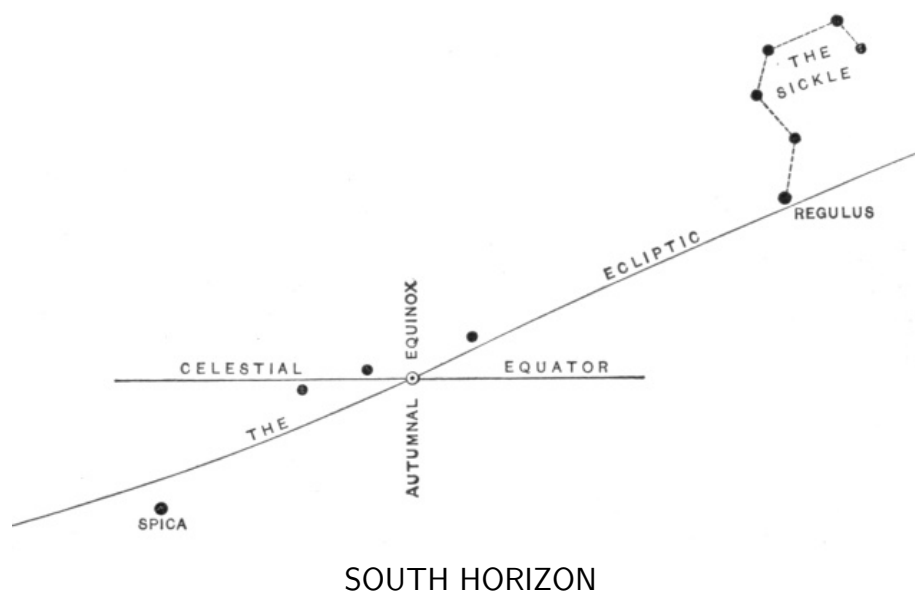

How to locate the Autumnal Equinox

indicate where the ecliptic lies. Also, if the moon is within three or four days of the phase known as the 'quarter,' her shape will show very nearly the direction of the ecliptic in this manner: Join the cusps by an imaginary line, and the perpendicular to this line, extended both ways, will mark out the ecliptic very nearly. In early evening, the problem is easier. On about half the nights of the year the moon will afford one point. Usually one or more of the brighter planets (Venus, Mars, Jupiter, Saturn) will be visible, and it has already been shown how to distinguish them from the brightest of the fixed stars. Like the moon, these planets never wander far from the ecliptic; and if we pass our imaginary plane through any two of them, the direction of the ecliptic may be traced upon the sky.

If moon and planets are invisible, the positions of known stars are all that we can rely upon, and there are few very bright stars near the ecliptic. The Pleiades and Aldebaran (Alpha Tauri) are easy to find all through autumn and winter, and the ecliptic runs midway between them. Through winter and spring, the 'sickle' in Leo is prominent, and Regulus (Alpha Leonis) is only a moon's breadth from the true ecliptic. Through the summer Spica (Alpha Virginis) is almost as favorably placed; and Antares (Alpha Scorpii) rather less so, but not exceeding 10 moon breadths south of the ecliptic. And in late summer and autumn, Delta Capricorni, much fainter than all those previously mentioned, shows where the ecliptic lies through a region almost wholly devoid of very bright stars. As the stars before named are so set in the firmament that at least two of them must

always be above the horizon, they show approximately where the ecliptic lies.

Finding the Latitude.—Having shown how the stars and constellations may be learned in our latitudes, it is next necessary to find how their courses seem to change, as seen from other parts of the earth. It is plain that going merely east or west will not alter their courses. The effect of changing one's latitude must therefore be ascertained. Observe Polaris: attention has already been directed to the fact that in middle northern latitudes, as the United States, it is about halfway up from the northern horizon to the zenith. The true north pole of the heavens is $1^{\circ} 15'$, or two and a half moon breadths from it. If you had a fine instrument of the right kind, and the training of a skillful astronomer,

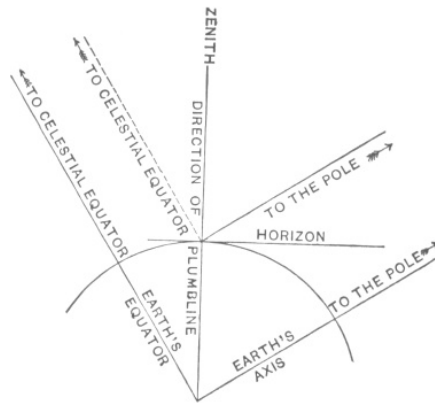

Latitude equals Altitude of Pole

you could measure accurately the altitude of the pole star when exactly below the pole. Measure it again 12 hours later, and it would be directly above that point. The average of the two altitudes, with a few slight but necessary corrections, would be the true altitude of the center of the little circle in which the pole star seems to move round once each day. This center is the true north celestial pole; and whatever its altitude may be found to be, a facile proof by geometry shows that it must be equal to the north latitude of the place where the observations were made.

Latitude equals Altitude of Pole.—Whether the earth is considered a sphere or an oblate spheroid, the angle which the plumb-line at any place makes with the terrestrial equator is equal to the latitude (figure above). As the plane of celestial equator is simply terrestrial equator-plane extended, the declination of the zenith is the same angle as the latitude. Now consider the two right angles at the point of observation; (*a*) the one between celestial equator and pole, and (*b*) the other between horizon and zenith: the angle between pole and zenith is a common part of both. So the declination of the zenith is equal to the altitude of the pole. Therefore *the altitude of the pole at any given place is equal to the latitude of that place.*

Going North the Pole Star rises.—If, then, one were to go north on the surface of the earth 1° , the pole of the northern heavens must seem to rise 1° . For example, if the latitude is 42° , one would have to travel due

north 48° (3300 miles) in order to reach the north pole of the earth. And as the altitude of the celestial pole would have increased 48° also, evidently this point and the zenith would exactly coincide. To all adventurous explorers who may ever reach the north pole, we may be sure that the pole star will be all the time very nearly overhead, and travel round the zenith once every day in a small circle whose diameter would require about five moons to reach across. All other stars would seem to travel round it in circles parallel to it and to the horizon also. This peculiar motion of the stars as seen from the north pole was the origin of the term *parallel sphere*.

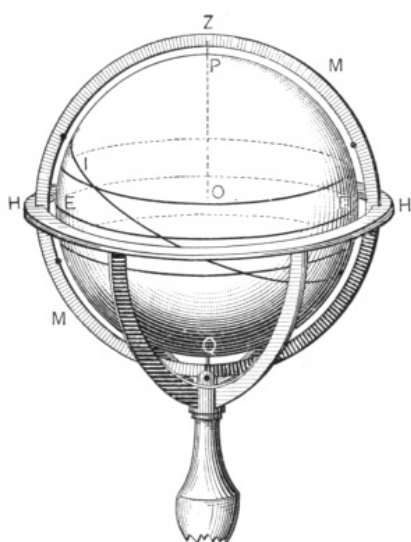

Parallel Sphere (at the Poles)

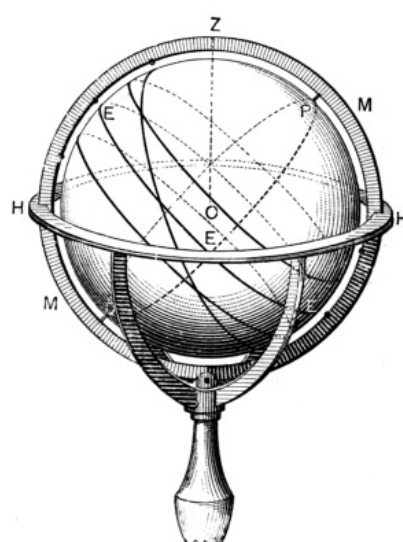

Oblique Sphere (Northern U. S.)

Daily Motion of the Stars at the North Pole.—At the north pole the directions east and west, as well as north, vanish, and one can go only south, no matter what way one may move. As seen from the north pole, the stars all move round from left to right perpetually, in small circles parallel to the horizon. Consequently they never rise or set. All visible stars describe their own almucantars once every day. Their altitudes are constant, and their azimuths are changing uniformly with the time. The azimuths of all stars change with equal rapidity, no matter what their declination may be. These are the phenomena of the parallel sphere. All the stars north of the equator are always above the horizon, day and night. None of those south of the equator can ever be seen. If the observer were at the south pole of our globe, the daily motion of the stars relatively to the horizon would be exactly the same as at the north pole; but they would all seem to travel

round from right to left. The stars of the hemisphere which could be seen all the time would be those which from the north pole could never be seen at all.

Daily Motion of the Stars in the United States.—We have now returned from the north polar regions to middle latitudes, or N. 45° , about that of places from Maine to Wisconsin. The pole has gone down, too, and is elevated just 45° above the horizon; consequently the circle of perpetual apparition, or parallel of north declination which is tangent above the north horizon, has shrunk to a diameter of 90° on the sphere. Any star ever seen between the zenith and the north horizon can never set. Similarly the circle of perpetual occultation must be 90° in breadth: it is the parallel of south declination which is tangent below the south horizon. Therefore the breadth of the middle zone of stars, partly above and partly below the horizon, is 90° . The quadrant from the zenith to the south horizon is

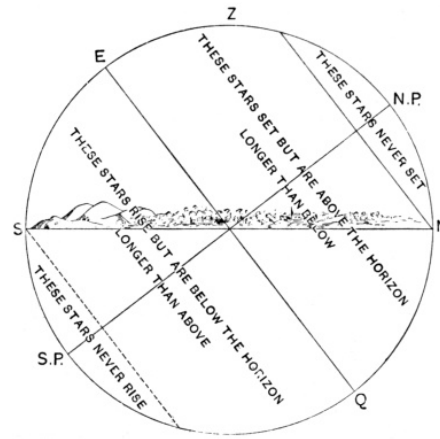

Circles of Perpetual Apparition and Perpetual Occultation

the measure of its breadth when above the horizon, and the distance from the north horizon to the nadir is its width when below the horizon. As in the polar regions, so here—the celestial equator marks the middle of the zone. All the stars in the northern half of it are visible longer than they are invisible, and the farther north they are, the longer they are above the horizon. In the same way all the stars of this zone whose declination is south are invisible longer than they are visible, and the greater their south declination, the longer they are below the horizon. It has now been shown how the apparent motions of the stars are accounted for by the geometry of the sphere.

Daily Motion of the Stars at the Equator.—Here our latitude is zero; and as the altitude of the north celestial pole is always equal to the north latitude, the north pole must now be in the horizon itself. As the poles are 180° apart, evidently the south pole of the heavens must now be in the south horizon. The equator, then, must pass through the zenith, and the stars can rise, pass over, and set, in vertical planes only, whence the name *right sphere*. A star's diurnal circle, therefore, is coincident with its parallel of declination. But what is now the size of the circles of perpetual

apparition and occultation? It is evident that they must have shrunk in dimensions more and more as we journeyed south. The circle of perpetual

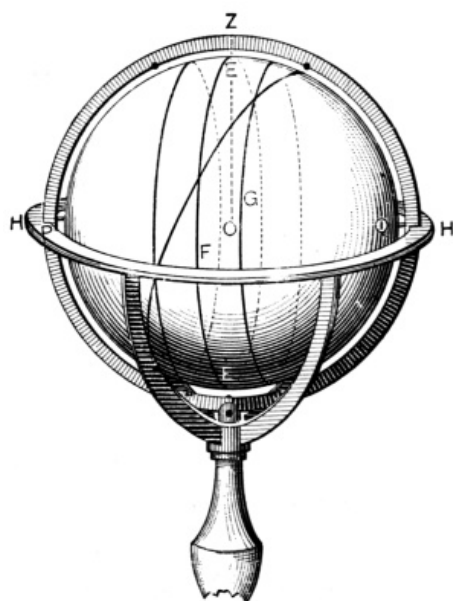

Right sphere (at Equator)

apparition is now a mere point,—the north pole itself; and the circle of perpetual occultation is a point also,—the south pole. No star, then, can be visible all the time, nor can any be invisible all the time. The equatorial zone of stars, visible part of the time and invisible the remainder of each day of 24 hours, has expanded to embrace the entire firmament. Every star, no matter what its declination, is above the horizon 12 sidereal hours and below it 12 hours, and so on alternately forever.

The Equatorial at Different Latitudes.—Remembering that the principal axis of the equatorial telescope must always be directed toward the pole of the heavens, it is easy to see what the construction

of the instrument must be, to adapt it for use in different latitudes. At the pole itself, were an equatorial telescope required for that latitude, the polar axis would be vertical (on the next page); and the equatorial would not differ at all from the altazimuth. As we travel from the pole into lower latitudes, the polar axis is tilted from the vertical accordingly; until at the equator it becomes actually horizontal, as illustrated adjacent. An equatorial mounted at middle latitudes has already been shown on page 45. It must not be thought that this change of latitude and corresponding inclination of the polar axis modifies in any way the relations of other parts of the equatorial. The polar axis is always in the meridian; and its altitude, or the elevation of its poleward end, is always equal to the latitude. The polar axes of equatorial telescopes in all the observatories of the world are parallel to one another.

Large equatorial mountings, or those rigid enough to carry a telescope above six inches aperture, always have the frame or pier head cast by the maker in such form that the bearing for the polar axis shall stand at the angle required by the latitude of the place where the telescope is to be used; smaller instruments, called

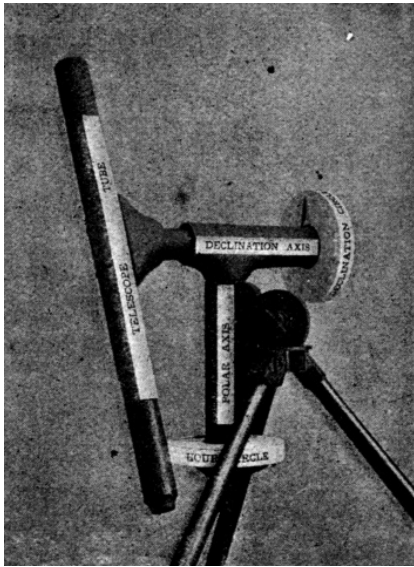

Equatorial at the Poles

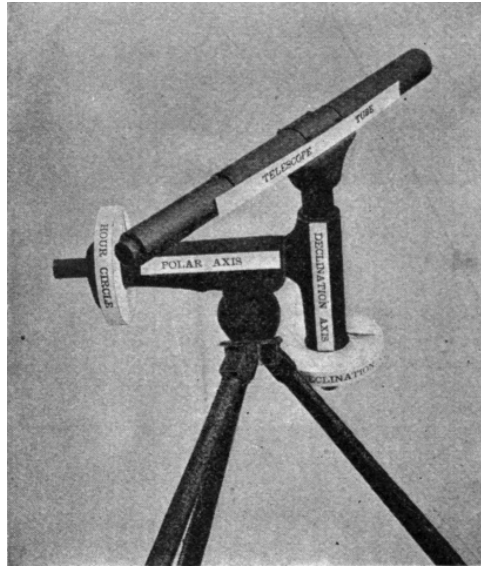

Equatorial at the Equator

portable equatorials, generally have the bearing of the polar axis attached to the pier, stand, or tripod, by means of a rigid clamp; the polar axis can then be tilted to correspond to any required latitude, as shown by a graduated quadrant or otherwise. Such portable, or universal, equatorials are an essential part of the equipment of eclipse and other astronomical expeditions. As the polar axis is reversed, end for end, in passing from one hemisphere to the other, the clockwork motion must be reversible also, because the stars move from east to west in both hemispheres.

Our next inquiries are directed toward the astronomical relations of the earth on which we dwell, its form and size, and the elementary principles by which these facts are ascertained.

Chapter V

The Earth as a Globe

The original idea of the earth, as given in the Homeric poems, was that of an immense, flat, circular plane, around which Oceanus, a mythical river, not the Atlantic, flowed like a vast stream. It was thought to be bounded above by a hollow hemisphere turned downward over it, through and across which the heavenly bodies coursed for human convenience and pleasure.

Ancient Idea of the Earth.—Anaximander (B.C. 580) regarded the earth as a flat, circular section of a vertical cylinder, with Greece and the Mediterranean surrounding the upper end. Herodotus (B.C. 460), whose geographic knowledge was extensive, ridiculed the idea of a flat and circular earth. To Plato (B.C. 390), the earth was a cube. Even as late

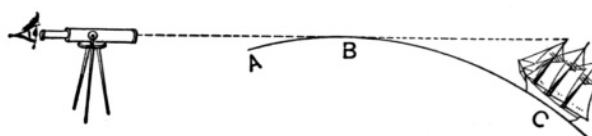

Curvature of the Ocean exaggerated

as A.D. 550, Cosmas drew the earth as a rectangle, twice as long (east and west) as it was broad (north and south), from which conception have originated the terms *longitude* (length) and *latitude* (breadth); and from the four corners of this rectangular earth rose pillars to support the vault of the sky. The venerable Bede (A.D. 700) promulgated the theory of an egg-shaped earth, floating in water everywhere surrounded by fire. Long before this, however, Thales (B.C. 600) and Pythagoras (B.C. 530) had taught that the earth was spherical in form; but the erroneous beliefs persisted through century after century before the doctrine of a globular earth was fully established. Final doubt was swept away by the famous voyage of Magellan, one of whose ships first circumnavigated the globe in the 16th century, and in three years returned to its starting point.

How to see the Curvature of the Earth.—By ascending to greater and greater heights above the earth's surface, the horizon retreats farther

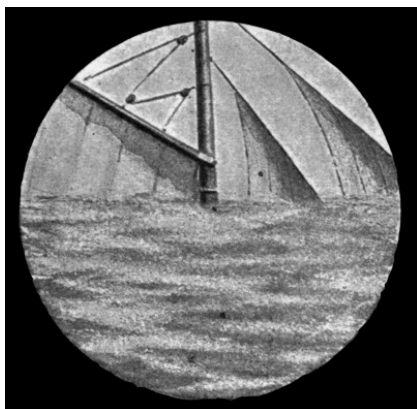

Ship's Rigging Distinct, Water Hazy

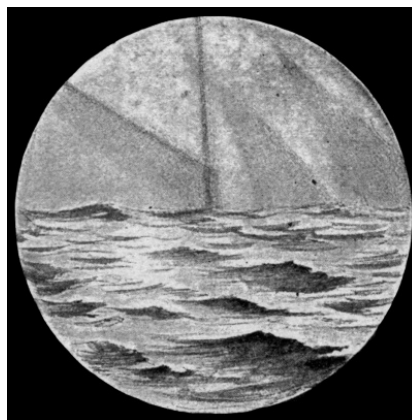

Water Distinct, Rigging ill-defined

and farther. If we ascend a peak in mid-ocean, the extension of the radius of vision may be seen to be the same in every direction, thus indicating a spherical earth. But a better experimental proof may be had. Near the shore of a large body of water, on a fine day when ships can be seen far out, mount a telescope (as on the preceding page) upon a high building or cliff. The intervening water will be imperfectly seen (on the current page), but the ship's masts and rigging well defined, if all conditions are favorable. Now draw out the eyepiece of the telescope until the waves on the horizon line appear sharply defined. The details of the ship will then be hazy and indistinct, because the ship is farther away than the water which hides her hull. Repeat the observation by focusing the telescope alternately on the ship and the water in the same field of view,—affording ocular proof that the earth's surface curves away from the line of vision. Wherever this simple experiment is tried, the result will be the same; so we reach the conclusion that the earth is round like a ball.

Telegraphic Proof that the Earth is Round.—Farther proof that the earth is not a plane may be derived with the assistance of the electric telegraph. If the earth were a plane, local time would everywhere be the same. This condition is shown in the above figure, for Denver, Chicago, and New York: the lines of direction in which the sun appears from all three places are parallel, because the distance separating them is not an appreciable part of the sun's true distance. Therefore, as the sun's angle east of the meridian corresponds to 10 A.M. at one place, it should be 10 A.M. at all. But at 10 A.M. at Chicago, if the operator asks New York and Denver what time it is at those places, he will receive the answer that it is 9 o'clock at Denver and 11 at New York. The sun, therefore, must be 15° east of the meridian at New York, as shown in the figure below, 30° at

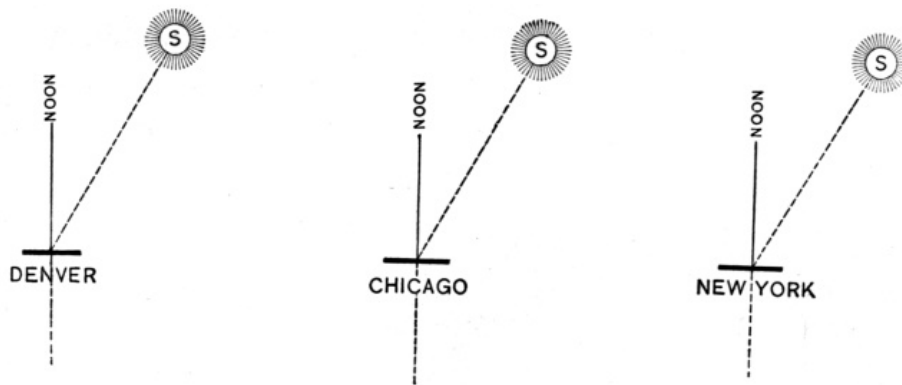

Earth a Plane, Local Time everywhere the Same

Chicago, and 45° at Denver. So the meridian planes of these three places cannot be parallel, as in the first illustration, but must converge below the earth's surface, as shown in the second one.

By means of land lines and cables, the local time has been compared nearly all the way round the globe, eastward from San Francisco to New York, across the Atlantic Ocean, over the eastern hemisphere, through Europe and Asia to Japan. Everywhere it is found that meridians converge downward in such a way

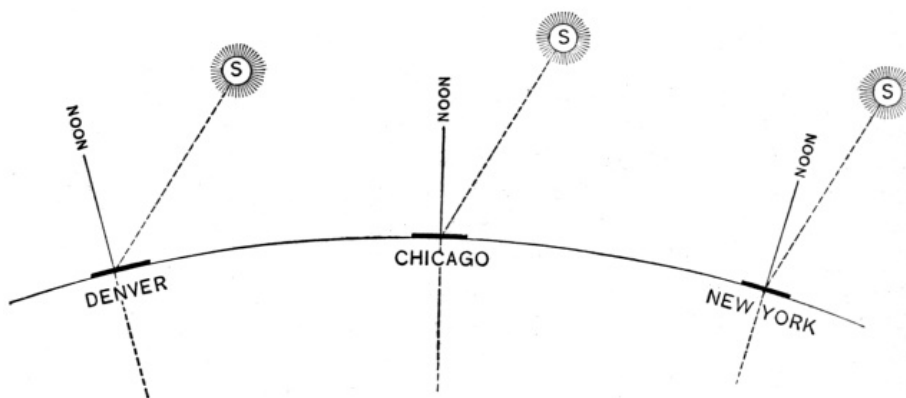

Earth a Globe, Local Time depends on the Longitude

that all would meet in a single line. This geometric condition can be fulfilled only by a solid body, all of whose sections perpendicular to this common line are circles. Therefore the earth is round, east and west; and, by going north and south in different parts of the earth, and continually observing the change in meridian altitudes of given stars, it is found that the earth is round in a north

and south direction also. But all these curvatures as observed in different places nearly agree with each other; therefore, the earth is nearly a sphere.

History of the Measurement of the Earth.—While the Chaldeans are credited with having made the first estimate of the earth's circumference (24,000 miles), the Greeks, beginning with Aristotle (B.C. 350), made noteworthy efforts to solve this important problem, which is preliminary to the measurement of all astronomical distances. Eratosthenes (B.C. 240) and Cleomedes (A.D. 150) applied the gnomon to the measurement of degrees on the earth's surface, and devised the application of geometry to this problem essentially as it is employed to-day. They made Syene $7^{\circ} 12'$ south of Alexandria; and as the measurement of distance between these places made them 5000 stadia apart, the proportion

$$7^{\circ}.2 : 360^{\circ} :: 5000 : —$$

gave for the circumference of the earth 250,000 stadia, or 24,000 miles.

Posidonius (B.C. 260) made a similar determination between Rhodes and Alexandria. Early in the ninth century of our era, the Arabian caliph Al-Mamun directed his astronomers to make the first actual measurement of an arc of a terrestrial meridian, on the plain of Singar, near the Arabian Sea. Wooden poles were used for measuring rods, but the result is uncertain, because the details of the corresponding astronomical observations are not known. Fernel, in France, measured a terrestrial arc early in the 16th century, adopting a method like that of Eratosthenes, and beginning that brilliant series of geodetic measures which, through succeeding centuries, did much to establish the scientific prestige of France. Also Picard measured an accurate arc of meridian in 1671, used by Newton in establishing his law of gravitation.

Geodesy.—Geodesy is the science of the precise measurement of the earth. Accurate geodetic surveys have been conducted during the present century in England, Russia, Norway, Sweden, Germany, India, and Peru; and eventually the transcontinental measurements, completed in the year 1897 by the United States Coast and Geodetic Survey, will make a farther and highly important contribution to our knowledge of the size and figure of the earth. Evidently an arc of a latitude parallel may make additions to this knowledge, as well as an arc of meridian. In the former case the astronomical problem is to find the difference of longitude between the extremities of the measured arc; in the latter, the corresponding difference of latitude. The processes of geodesy proper—that is, the finding out how many miles, feet, and inches one station is from another—are conducted by a system of indirect measurements called triangulation.

Triangulation.—Although Ptolemy (A.D. 140) had shown that an arc of meridian might be measured without going over every part of it, rod by rod, the first application of his important suggestion was made by Willebrord Snell, a Netherland geometer of the 17th century. Trigonometry is the science of determining the unknown parts of triangles from the known. When one side is known and the two angles at its ends, the other sides can always be found, no matter what the relative proportions of these sides. It is evident, then, that if a short side has been measured, the long ones may be found by the much simpler, less tedious, and more accurate process of mathematical calculation. Triangulation is the process of finding the exact distance between two remote points by connecting them by a series or network of triangles. The short side of the primary triangle, which is actually measured, foot by foot, is

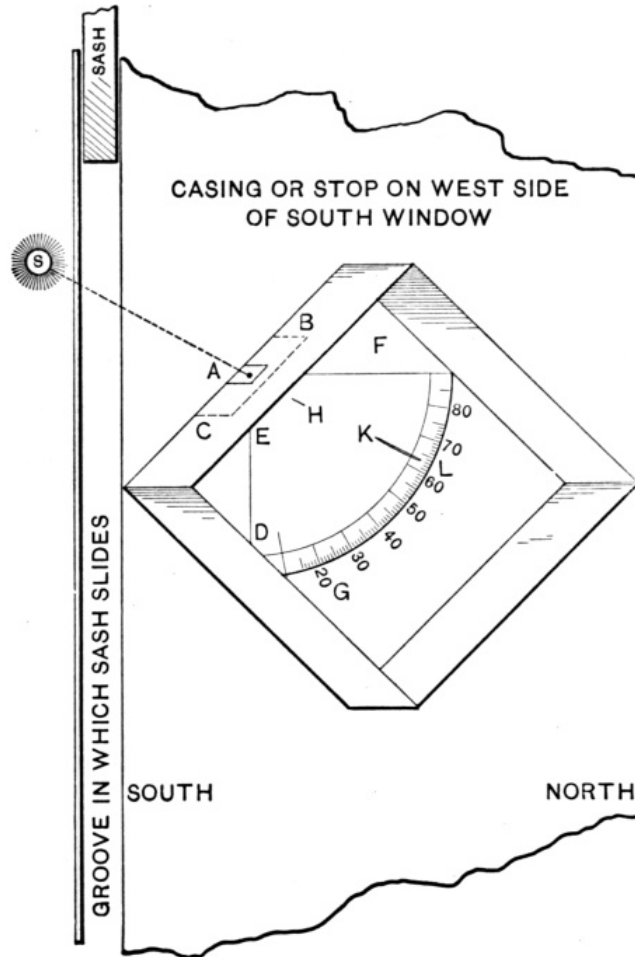

The Latitude-box in Position

called the *base*. For the sake of accuracy the base is often measured many times over. Thenceforward, only angles have to be measured—mostly horizontal angles; and this part of the work is done with an altazimuth instrument. We must pass over the explanation of the somewhat complex process of getting the single desired result from a rather large mass of observations and calculations. The base must not be too short; and the stations must be so selected as to give *well-conditioned triangles*. Of course an equilateral triangle is well-conditioned

in the extreme, and good judgment is required in deciding how great a departure from this ideal figure is allowable. The triangle on page 209, with the earth's diameter as a base, is exceedingly ill-conditioned. Snell's base was measured near Leyden; but it was shorter than it should have been; the telescope was not then available for accurate measurement of angles; and some of his triangles were ill-conditioned, consequently his result for the size of the earth was erroneous. The geometers of to-day employ the principles of his method unchanged, but with great improvement in every detail.

Earth's Size and Volume.—As a result of such labors, it is found that the length of the shortest diameter of the earth, or the distance between the two poles, is 7900 miles. In the plane of the equator, the diameter of our globe is 7927 miles, or about $\frac{1}{300}$ part greater than the diameter through the poles. This fraction is a little less than the oblateness of the earth or its polar compression. Recent measurements indicate that the equator itself is slightly elliptical, but this result is not yet absolutely established. The form of the earth may therefore be regarded as an ellipsoid with three unequal diameters, or axes. Knowing the lengths of these diameters, the volume of the earth has been calculated and found to be 260 billion cubic miles. As the size of the earth was first determined by measuring the length of a meridian arc, and comparing it with the difference of latitude at the two ends of the arc, we next describe an easy method of finding the latitude.

How to observe the Latitude.—It is probable that you can take the latitude of the place where you live, more accurately from the map in any geography, than you can find it by the method about to be described. But the principle involved is often used by the astronomer and navigator, and it is important to understand it fully, and to test it practically, although there may be at hand no instrument better than a plumb-line and a pasteboard box.

A box about six or seven inches square should be selected. The depth of the box is not important—four or five inches will be convenient. Cut a hole $\frac{1}{4}$ inch square (*A*) through the middle of one side, at the bottom. On the inside paste a piece of letter paper over this hole, as indicated by the dotted line *CB* (on the preceding page). Transfer a duplicate of the above graduated arc to a stiff sheet of highly calendered paper or very smooth bristol board about four inches square. Trim the little quadrant accurately, taking especial care that the edges of it at the right angle shall exactly correspond with the lines. The quadrant is now to be pasted on the inside of the bottom of the box, in such a way that the center of the arc, or the right-angled point, will be in contact with the bit of paper pasted over the aperture. One thing more, and the latitude-box is complete: exactly opposite the right-angled apex of the quadrant, and perhaps a sixteenth of an inch away from its plane, pierce a pin hole through the letter paper. Now select a

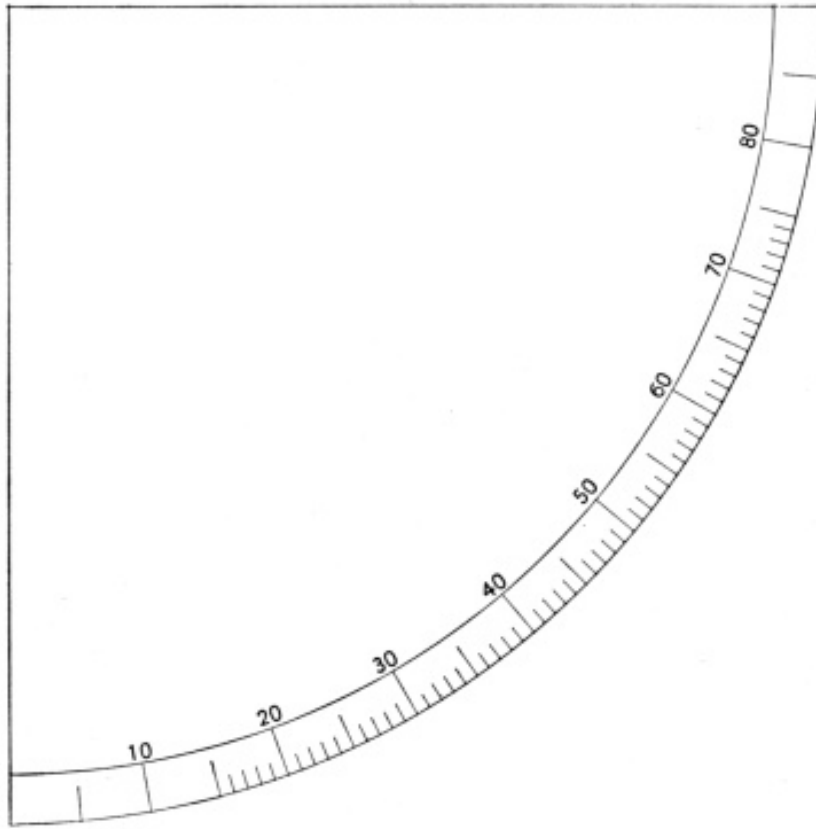

GRADUATED QUADRANT (To be copied in the latitude-box, for measuring the Sun's zenith distance at apparent noon)

window facing due south, and tack the box on the west face of its casing, so that the quadrant will be nearly in the meridian. The illustration on page 71 shows how it should be fastened. Put in a tack at *F*. Then hang a plumb-line by a fine thread in front of the box, and sight along it, turning the box round the tack until the line *ED* is parallel to the plumb-line. Then tack in final position at *G*, and verify the direction of *ED* by the plumb-line afterwards. The latitude-box is now ready for use.

To make the Observation.—On any cloudless day, about half an hour before noon, the sunlight falling through the pin hole will make a bright elongated image at *H*. As the sun approaches nearer and nearer the meridian, this image will travel slowly toward *K*, becoming all the time less bright, but more elongate. Just before apparent noon it will appear as a light streak, *KL*, about one degree broad, and stretching across the graduation of the quadrant. The observation is completed by taking the reading of the middle of this light streak on the arc,

to degrees and fractional parts as nearly as can be estimated. It is better to set down this reading in degrees and tenths decimally.

To calculate or reduce the Observation.—Only a single principle is necessary here, because in our latitudes refraction by the air (page 79) will never be an appreciable quantity. Take

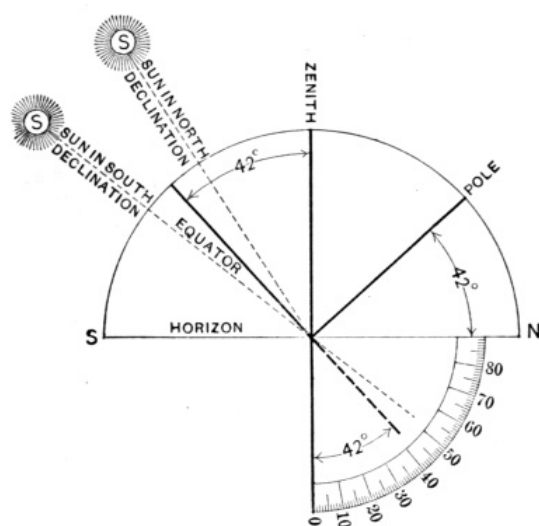

Latitude equals Zenith Distance plus Declination

the sun's declination from table on the next page. The above diagram shows how it should be applied to the reading on the arc. If declination is south, subtract it from the reading on arc of the quadrant, and remainder is the latitude. But if sun's declination is north, add it to the quadrant reading, and the sum will be equal to the latitude. The quadrant reading is sun's zenith distance; and the single principle employed is the fundamental one: that the altitude of the pole (or declination of zenith) is equal to the latitude.

The Sun's Declination.—The sun's declination is its angular distance either north or south of the celestial equator. It varies from day to day, and may be taken from Table 5.1, with sufficient accuracy for the foregoing purpose.

The values are adjusted to every tenth day through the year. Find the value for any intermediate date proportionally.

How the Latitude is found accurately.—But while a crude method like the foregoing has a certain value as illustrating the outline of a principle, it is of no importance to the astronomer, because of the impossibility of eliminating the very large errors to which it is subject. He therefore employs a variety of other methods. The best is the method of equal zenith distances.

The instrument for measuring them is called the zenith telescope. Two stars are selected whose declinations are such that one of them culminates as far north of zenith as the other does south of it. The telescope is constructed with a delicate level attached to its tube, so that it can be clamped rigidly at any angle. When the first star is observed set the level horizontal: then turn the instrument round 180° , taking care not to disturb the

Table 5.1: THE SUN'S DECLINATION AT APPARENT NOON

DAY	DECL.	DAY	DECL.	DAY	DECL.
Jan. 1	23°.0 S.	May 1	15°.2 N.	Aug. 29	9°.2 N.
11	21.7 S.	11	18.0 N.	Sept. 8	5.5 N.
21	19.8 S.	21	20.3 N.	18	1.6 N.
31	17.2 S.	31	22.0 N.	28	2.2 S.
Feb. 10	14.2 S.	June 10	23.0 N.	Oct. 8	6.1 S.
20	10.7 S.	20	23.5 N.	18	9.8 S.
Mar. 2	7.0 S.	30	23.2 N.	28	13.3 S.
12	3.1 S.	July 10	22.2 N.	Nov. 7	16.5 S.
22	0.8 N.	20	20.6 N.	17	19.1 S.
Apr. 1	4.7 N.	30	18.4 N.	27	21.2 S.
11	8.5 N.	Aug. 9	15.7 N.	Dec. 7	22.7 S.
21	12.0 N.	19	12.6 N.	17	23.4 S.
May 1	15.2 N.	29	9.2 N.	27	23.3 S.

level. The second star will cross the field of view, because the telescope will now be pointing as far on one side of zenith as it was on opposite side in the first position. Declinations of both stars must be accurately known; and these, with small corrections depending upon instrument and atmosphere, give the means of calculating latitude with great precision. The zenith telescope is usually a small instrument, perhaps 3 feet high. The one here shown is employed by Doolittle at the Flower Observatory of the University of Pennsylvania, in making the critical observations described at the end of this chapter. At fixed observatories the latitude is generally determined by means of the meridian circle (described on page 191).

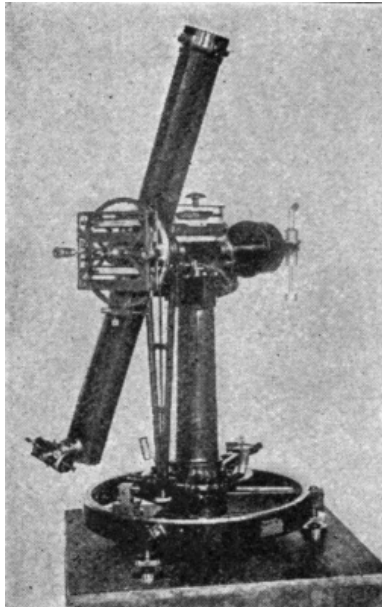

Zenith Telescope (Warner & Swasey)

Length of Degrees of Latitude and Longitude.—The length of a degree on the equa-

tor is $69\frac{1}{6}$ statute miles. At the equator a degree of longitude and a degree of latitude are very nearly equal in length, the latter being only about $\frac{1}{150}$ part shorter. Leaving the equator, degrees of longitude grow rapidly shorter, because meridians converge toward the pole. In latitude 30° the degree of longitude has shrunk to 60 miles, so that a minute of longitude is covered for every mile traveled east or west. In the United States, average length of a minute of longitude is $\frac{7}{8}$ of a mile.

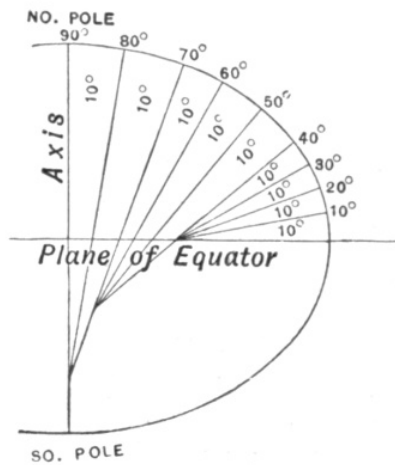

Degrees grow Longer toward the Poles

By measuring degrees of meridian at various latitudes, they are found invariably longer, the nearer the pole is approached. So curvature of meridians must decrease toward the pole, because the less the curvature of a circle, the longer are degrees upon it. The figure on this page shows this effect much exaggerated, but actual differences are not large; at equator the length of a degree of latitude is $68\frac{3}{4}$, in the United States almost exactly 69, and at the pole $69\frac{3}{8}$ miles. The angle between equator-plane and a line from any place to earth's center is called its geocentric latitude; and the difference between it and ordinary or geographic latitude is the *angle of the vertical*. It is zero at poles and equator, and amounts to about $11'$ at latitude 45° , geocentric being always less than geographic latitude.

Terrestrial Gravity.—By gravity is meant the natural force exerted on all terrestrial matter, drawing or tending to draw it downward in the direction of the plumb-line. All objects, as air, water, buildings, animals, earth, rock, metals, are held in position by this attraction, and it gives them the property called weight. As we know, if the earth were dug away from under us, we should fall to a point of rest nearer the earth's center. If gravity did not exist, all natural objects not anchored firmly to earth would be free to travel in space by themselves. The ultimate cause of this force has not yet been ascertained, but its law of action has been fully investigated (page 336). It diminishes as we go upward, being a thousandth part less on a mountain 10,000 feet high. Gravity remains constant at a given place, and is exerted upon all objects alike. If unobstructed, all fall to the earth from a given height in exactly the same time.

Try the experiment for yourself, using two objects to which the air offers

very different resistance—a silver dollar, and a piece of tissue paper about half an inch square. Hold the coin delicately suspended horizontally between thumb and finger. Practice releasing the coin so that it will remain horizontal while dropping. Then place the paper lightly on top of the coin. The paper will fall in exactly the same time as the coin does, because the coin has partially pushed the air aside, and permitted gravity to act upon the paper, quite unhampered by resistance of the atmosphere. The coin pushes the air aside and falls as quickly as the paper falls without pushing the air aside. But the fall of the coin is not appreciably delayed by aerial resistance, and both coin and paper fall through the same distance in the same time.

The Earth's Form found by Pendulums.—If a delicately mounted pendulum of invariable length is carried from one part of the globe to another, it is found from comparison with timepieces regulated by observations of the stars, that its period of oscillation, or swinging from one side of its arc to the other, is subject to change. Richer first tested this in 1672. By carrying from Paris to Cayenne a clock correctly regulated for the former station, he found that it lost 2m. 28s. a day at the latter; and it was necessary to shorten the pendulum accordingly. Now, conversely, preserve the length of the pendulum absolute, and record the exact amount of its gain or loss at places differing widely in latitude and longitude; then it will be possible to find their relative distance from the center of the earth, because the law connecting the oscillation of the pendulum with the force of gravity at different distances from the earth's center is known. At the sea level in the latitude of New York, a pendulum oscillating once a second is 39.1 inches long, and the times of vibration of pendulums vary as the square root of their lengths. This kind of a survey of the earth is called a *gravimetric survey*, and operations in the process are termed *swinging pendulums*.

In this manner it has been ascertained that the force of gravity at the earth's poles must be about $\frac{1}{190}$ greater than at the equator. But in order to find the earth's figure, this result must be corrected because the effect of the earth's attraction is everywhere (except at the poles) lessened on account of the centrifugal force of its rotation. It is greatest at the equator, amounting to $\frac{1}{289}$. Subtracting this from $\frac{1}{190}$, the remainder is about $\frac{1}{555}$. This result makes the earth's equatorial radius about $13\frac{1}{2}$ miles longer than its polar radius, thereby verifying the value derived from the measures of meridian arcs. Pendulum observations can be made at numerous localities where the contour of the surface is so irregular that measurement of arcs is impracticable. Besides this, the swinging of pendulums has revealed many interesting facts regarding the earth's crust; important among them being this—that the mountains of our globe are relatively light, and some of them mere shells. American geometers who have contributed most to these

researches are Peirce and Preston.

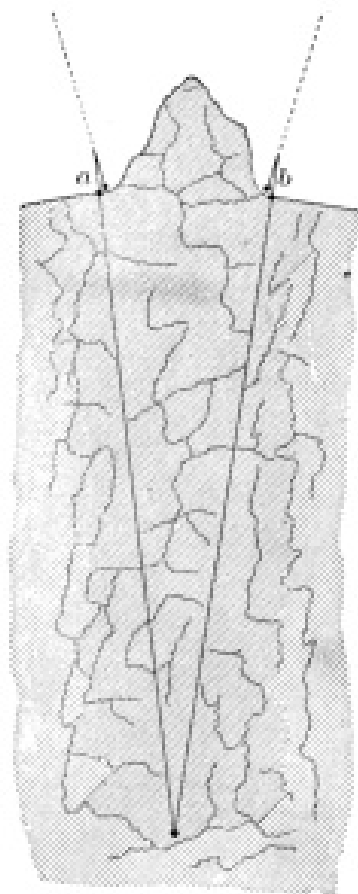

Weighing the Earth

Weighing the Earth.—The mass of the earth is six thousand millions of millions of millions of tons. Perhaps this statement does not assist very much in realizing how heavy the earth actually is; but it may arouse interest in regard to methods of reaching such a result. Several have been employed, but the bare outline of the first one ever tried is indicated by the figure of a section of the earth surmounted by a rather abrupt mountain. The straight lines drawn downward (one from the north and the other from the south side of the mountain) converge toward the center of the earth. Outward toward the stars each line would point in the direction of the zenith of the station *a* or *b*, if the mountain were not there. But the attraction of the mountain mass draws toward itself the plumb-lines suspended on both sides of it; so that the difference of latitude of the two stations is made greater by the amount that the angle of the dotted lines exceeds the angle at the center of the earth. But the true difference of latitude between *a* and *b* can be found by surveying round

the mountain. This survey, too, must be so extended that the volume of the mountain may be ascertained; geologists examine its rock structure, and its actual weight in tons is calculated. Then by a mathematical process the earth is weighed against the mountain, and the result in tons given above is obtained from the ratio of the mass of our globe to the mass of the mountain. Schiehallion in Scotland was the mountain first utilized in this important research, about a century ago. As a result of all the measures of different methods, the earth's mean density is found to be 5.6. This means that if there were a globe entirely composed of water and of exactly the same volume as our globe, the real earth would weigh 5.6 times as much as the sphere of water.

Atmospheric Refraction.—The earth is completely surrounded by a gaseous medium called the atmosphere. Even when perfectly tranquil, the atmosphere has a remarkable effect upon the motion of a ray of light in bending it out of its course. Two properties true of all gases are concerned in atmospheric refraction—weight and compressibility. The atmosphere is probably at least 100 miles in depth; and gravity attracts every portion of it vertically downward. Its total weight is about 5×10^{15} (five quadrillions = 5,000,000,000,000,000) tons, or $\frac{1}{1200000}$ that of the entire earth. Conceive the atmosphere divided into layers concentric round the earth and one another, as above. The lowest shell must support not only the weight of the shell next outside it, but of all the other shells still beyond. Evidently, then, as the atmosphere is compressible, the force of gravity renders successive strata more and more dense as the surface of the earth is approached. The greater the density, the more the refraction; so that lower strata bend, or refract, rays of light out of their course more than upper layers do.

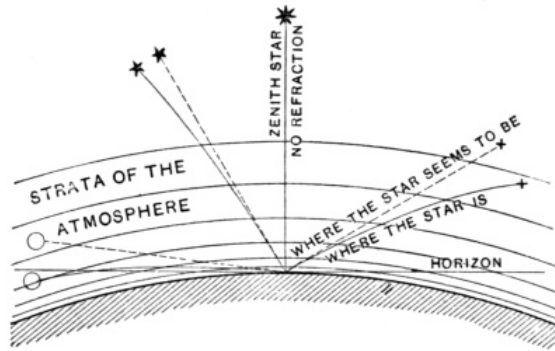

Refraction increases the Apparent Altitude

Refraction increases the Apparent Altitude

Law of Refraction.—According to the law of refraction, rays of light from any celestial body striking the air in the direction of the plumb-line, will pass downward along that line undeviated; but any rays impinging on the atmosphere otherwise than vertically—that is, rays from celestial bodies whose zenith distance is not zero—will be refracted more and more from their original course, the nearer they are to the horizon. The less the altitude, the greater the refraction; and, as an object always seems to be in that direction from which its rays enter the eye, refraction elevates the heavenly bodies, or makes their apparent altitude greater than their true altitude. The figure shows how refraction varies from zenith to horizon.

If the altitude is 45° , the refraction is $58''$, or nearly one minute of arc; but so rapidly does the density of the atmosphere increase near the earth's surface that the refraction at zenith distance 85° is $9' 46''$, more than 10 times greater than at 45° ; and increase in the next five degrees is even more rapid, so that the refraction at the horizon is $34' 54''$. A correction on account of refraction must be calculated and applied to nearly all astronomical observations. Generally

thermometer and barometer must both be read, because cold air is denser than warm, and a high barometer indicates increase of pressure of the superincumbent air. In both these instances the amount of refraction is increased. To determine how much the refraction was at the time when an astronomical observation was made at a given altitude, and to apply the corresponding correction suitably, is part of the work of the practical astronomer. It is greatly facilitated by means of elaborate *Refraction Tables*.

Effects of Atmospheric Refraction.—The angular breadth of the sun is, as we shall see, about one half a degree; and as this is nearly the

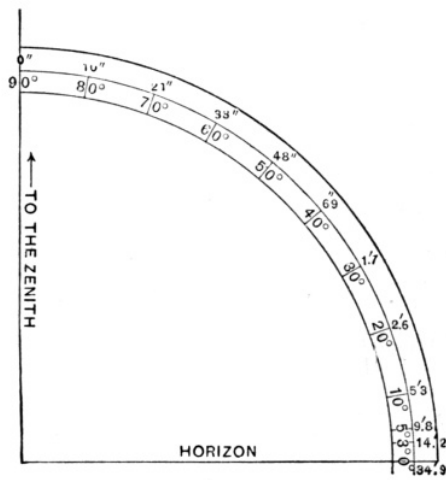

Refraction at Different Altitudes

amount of atmospheric refraction at the horizon, evidently the sun is really just below the sensible horizon when at its setting we still see it just above that plane. And as the diurnal motion of the celestial sphere carries the sun over its own breadth in about two minutes of time, refraction lengthens the day about four minutes, in the latitude of the United States; this effect being much increased as higher latitudes are reached. It is easy to see, also, that the sun must be continually shining on more than an exact half of the earth, refraction adding a zone about 40 miles wide extending all the way round our globe, and joining on the line of sunrise

and sunset. Farther effects of atmospheric refraction are apparent in those familiar distortions of the sun's disk often seen just before sunset. Refraction elevates the lower edge, or limb, more than the upper one, so that the sun appears decidedly flattened in figure, its vertical diameter being much reduced—an effect far more pronounced in winter than in summer.

Scintillation of the Stars.—Scintillation or twinkling of the stars is a rapid shaking or vibration of their light, caused mainly by the state of the atmosphere, though partly as a result of the color of their intrinsic light. That the atmosphere is a cause of twinkling is evident from the fact that stars twinkle more violently near the horizon, where their rays come to us through a greater thickness of air.

Also the stars twinkle more in winter than in summer; and very violent scintillations often afford a good forecast of rain or snow. Marked twinkling of the stars is an indication that the atmosphere is in a state of turmoil—currents

and strata of different temperatures intermingling and flowing past one another. The astronomer describes this state of things by saying that the 'seeing is bad.' Consequently, high magnifying powers cannot be advantageously used with the telescope. A star's light seems to come from a mere point, so that when its rays are scattered by irregular refraction, at one instant very few rays reach the eye, and at another many. This accounts for the seeming changes of brightness in a twinkling star. Ordinarily the bright planets are not seen to twinkle, because of their large apparent disks, made up of a multitude of points, which therefore maintain a general average of brightness. At a given altitude white or blue stars (Procyon, Sirius, Vega) twinkle most, yellow stars (Capella, Pollux, Rigel) a medium amount, and red stars (Aldebaran, Antares, Betelgeux) least.

Twilight.—At a particular and definite instant of contact with the sensible horizon, the sun's upper edge comes into view at sunrise and disappears at sunset. But long before sunrise, and a corresponding time after sunset, there is an indirect and incomplete illumination

diffused throughout the atmosphere. This is called *twilight*. Morning twilight is generally called *dawn*. In part twilight is due to sunlight reflected from the upper regions of the earth's atmosphere. As twilight lasts until the sun has sunk 18° below the horizon, evidently its duration in ordinary latitudes must vary considerably with the season of the year. But the variation dependent upon latitude itself is greater still. A vast twilight zone nearly 1500 miles wide completely encircles the earth.

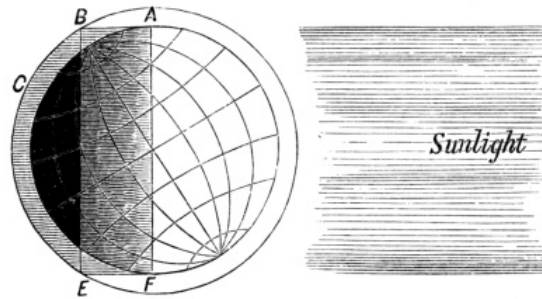

The Zone of Twilight in Midwinter

This zone, *ABEF* in the figure, is continually slipping round as our globe turns on its axis. One edge of it, along the line of sunrise and sunset, is constantly facing the sun. At the equator, where the sun's daily path is perpendicular to the horizon, the earth turns through this zone of twilight in about $1\frac{1}{4}$ hours. In the latitude of the United States, the average length of twilight exceeds $1\frac{1}{2}$ hours, its duration being greatest in midsummer, when it is more than two hours. At the actual poles of the earth, twilight is about $2\frac{1}{2}$ months in duration. If the earth had no atmosphere, there would be no twilight; the blackness of night would then immediately follow the setting of the sun.

The Aurora.—The aurora borealis (often called the northern lights) is

a beautiful luminosity, striated and variable, seen at irregular intervals, and only at night. From the general latitude of the United States, it appears as a soft vibrating radiance, streaming up most often into the northern sky, occasionally as far as the zenith, but usually in a semicircle or arch extending upward not over 30° . Its probable average height is about 75 miles. The aurora, generally greenish yellow in color, has occasionally been seen of a deep rose hue, as well as of a pale blue, and other tints. The continual vibration, sometimes the rapid pulsation, of its streamers, gives it a character of mystery only too well enhanced by our lack of knowledge of its causes. That these are connected with the magnetism of the earth is certain; also that a strong influence upon the magnetic needle is somehow exerted. Telegraph instruments and all other magnetic apparatus are greatly disturbed when auroras are brightest. This wonderful spectacle grows more frequent and pronounced, as the north pole is approached; and is closely connected, though in a manner incompletely understood, with the period of sun spots, and the protuberances. When there are many sun spots, auroras are most frequent and intense. Probably they are merely an electric luminosity of very rare gases.

The spectrum of the aurora is discontinuous (page 240), and far from uniform. Always there is one characteristic green line, all others being faint, and varying from one auroral display to another. At times there appear to be two superposed spectra. A similar phenomenon in the southern hemisphere is sometimes called *aurora australis*; also the general term *aurora polaris* is often applied to the auroras of both hemispheres.

The Wandering Terrestrial Poles.—Referring back to the remarkable photograph of stars around the northern celestial pole (page 30), we recall the fact that the center of all these arcs is that pole itself. And we may farther define the terrestrial north pole as that point in the earth directly underneath this celestial pole, or that point on our globe where the center of this system of concentric arcs would appear to be exactly in the zenith. But without actually going there, how can astronomers determine the precise position of this point on the earth's surface, and so find out whether it shifts or not? Evidently by finding as closely as possible, at frequent intervals of time, the latitude of numerous places widely scattered over the world. If the latitude of a place, Berlin, for example, is found to increase slightly, while that of another place on the opposite side of the globe, as Honolulu, decreases at the same time and by the same amount, the inference is that the position of the earth's axis changes slightly in the earth itself. So definite are the processes of practical astronomy that the position of the north pole can be located with no greater uncertainty than the area of a large

Eskimo hut. Nearly all the great observatories of the world are fully 3000 miles from this pole; still if this important point should oscillate in some irregular fashion by even so slight an amount as three or four paces, the change would be detected at these observatories by a corresponding change in their latitude. Such a fluctuation of the pole has actually been ascertained, and it affects a large mass of the observations of precision which astronomers and geodesists have made in the past. Technically it is called the variation of latitude.

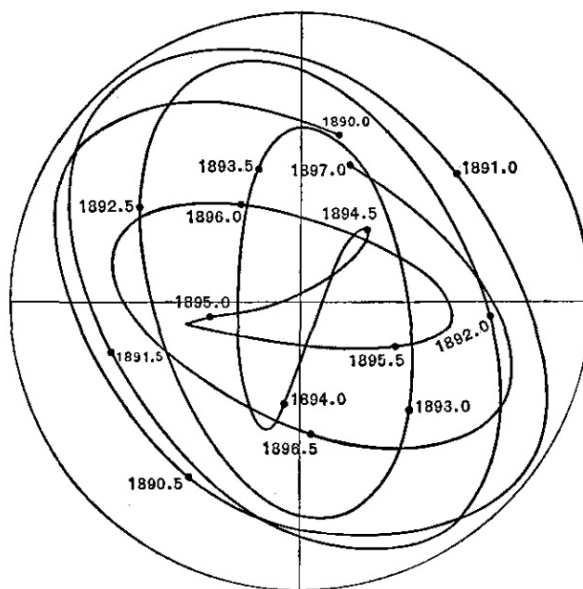

Observed Wandering of the North Pole

Only recently recognized, the physical cause of it is not yet fully established. But the nature and amount of it are already pretty well made out. Around a central point adjacent to the earth's north pole, draw a circle 60 feet in diameter, as shown in the illustration. Within this circle the pole has always been since the beginning of 1890. Its wanderings from that time onward to the beginning of 1897 are clearly indicated by the irregularly curved line which has been carefully laid down from a discussion of a large number of accurate observations of latitude at many observatories located in different parts of the world. Let the eye trace the curve through all its windings, and the meaning of the oscillation, or wandering of the north pole, will be appreciated. From the beginning of 1890 to January, 1894, the curve seems to have been roughly an in-winding spiral, the pole going round once in about 14 months. The latitudes of all places on the globe change by corresponding amounts. Chandler of Cambridge first brought clearly to light the variation of latitude, and American investigation of it has been farther advanced by Preston, Doolittle, and Rees. This movement of the pole is already sufficiently understood to enable astronomers to predict its future movements; and it seems probable that they will be confined within the narrow limits here indicated.

Were the earth at perfect rest in space, its poles would not partake of

this remarkable motion, in part dependent upon a slow turning round on its axis. The next chapter is concerned with this fundamental relation, of the utmost significance in astronomy, both theoretic and practical.

Chapter VI

The Earth Turns on its Axis

So far we have dealt only with the seeming motions of the heavenly bodies about us; in ancient times these were regarded as their actual motions. The glory of the sun by day, and all the magnificence of the nightly firmament were considered accessory to the earth on which men dwell. Till the time of Copernicus our abode was generally believed to be enthroned at the center of the universe. Now we know, what is far less gratifying to our self-importance, that this earth is only one—a very small one, too—of the vast throng of celestial bodies scattered through space, somewhat as moving motes in a sunbeam. All the stately phenomena of the diurnal motion, the appearances we have been studying, are easily and naturally explained by the simple turning completely round of our little earth on its axis once in a given period of time. This the ancient world naturally divided unevenly into day and night; but the astronomers of a later day, more philosophically, divide it into 24 hours, all of equal length, and this division is the only one recognized at the present day.

In the Dome of the Capitol.—Imagine yourself in the rotunda, or directly under the center of the dome of the Capitol at Washington. Turn once completely round from right to left, meanwhile observing the apparent changes in the objects and paintings on the inner walls of the dome. Just above the level of the eye, you face, one after another, all the twelve historical paintings exhibited in the rotunda. Turning round again at the same speed as before, the pillars half way up, apparently much reduced in size from their greater distance, seem to move more slowly. Turning round the third time, with the eyes directed still higher, the outer figures in the colossal painting at top, the ceiling of the dome, appear to turn more slowly still; while if you watch attentively the very apex of the dome, the central point of Constantio Brumidi's famous fresco will seem to have no motion whatever. This very simple experiment can be tried quite as effectively in the middle of any ordinary square room, first imagining its corners drawn inward, roughly to represent a dome. Seat yourself on a revolving piano stool

or a swivel chair, and, as you turn slowly round from right to left, watch the apparent motion of pictures on the wall, figures in the frieze, and spots on the ceiling. To confine the direction of vision look through a pasteboard roll, or other handy tube, elevating it to different altitudes as desired. Now it would be ridiculous to insist that the dome (or even the room) is turning around you, thereby causing these changes, while you are at rest in the center. Yet this was precisely the explanation of the apparent movement of the heavens accepted by the ancient world, false as it was, and very improbable as it would in our age seem to be. While the true doctrine of the rotation of the earth was held and taught by a few philosophers from very early times, it was not universally accepted till the downfall of the Ptolemaic system.

The Direction in which the Earth turns.—When riding swiftly through the street in a carriage or a car, it is quite easy, by imagining yourself at rest, to see, or seem to see, all the fixed objects—houses, shops, lamp-posts, and so on—rushing by just as swiftly in the opposite direction. Although you may be going east, you seem to be stationary, and they appear to travel west. While looking at the paintings in the Capitol (or the engravings on the wall) in succession as you turned round from right toward left, they appeared to be going just opposite—from left toward right. Now simply conceive all these objects to be moved outward in straight lines from the point of observation, each in the direction in which it lies, to a distance indefinitely great as if along the spokes of a vast wheel, whose hub is at the eye, but whose tire reaches round the heavens. When removed to a distance sufficiently great, we may imagine them to occupy places in the sky which some of the celestial bodies do. But we have seen that sun, moon, and stars all move in general from east to west, so we reach the easy and natural conclusion that our earth is turning over from west toward east. Once this cardinal fact of the earth's turning eastward on its axis is established and accepted, there is a full explanation of that apparent westward drift of which all the heavenly bodies, sun, moon, and stars in common, partake. Also the natural succession of day and night is robbed of its ancient mystery.

Proof that the Earth turns Eastward.—Quite independently of its point of suspension, a pendulum tends to swing always in that plane of oscillation in which it is originally set going. Suspend any convenient object, weighing one or two pounds, by a fine thread attached to the center of a stick or ruler. Hold it in both hands, and set the pendulum swinging in the plane of the stick. Then, without raising or lowering it, quickly swing the ruler quarter way round its center in a horizontal plane. The pendulum keeps on swinging in the same plane as before, although it is now at right angles to the ruler. Repeat the experiment several times, until you succeed in moving the stick without changing the position

of its center, and it will be seen that the ruler may be swung, either slowly or rapidly, into any position whatever, without affecting the plane of the pendulum's motion appreciably. Now imagine the short thread replaced by a very fine wire 200 feet long, suspending a ball weighing 70 or 80 pounds; and in place of the ruler turned round by hand substitute the Panthéon at Paris, turned slowly round in space by the earth itself. These are the conditions of this celebrated experiment as tried in 1851 by Foucault, a French physicist, who thereby provided ocular proof that the earth turns round from west toward east. He set the pendulum swinging in the plane of the meridian, but it did not long remain so. The south end of the floor being nearer the equator than the north end did, it traveled eastward a little faster than the north end did, so that the floor turned counter-clockwise underneath the swinging pendulum. Therefore, the plane of oscillation appeared to swing round clockwise. This experiment has been repeated in different parts of the earth, and always with the same result. The four figures on the current page show the varying conditions. In the southern hemisphere the pendulum appears to turn round counter-clockwise. As for the rate of turning, at either pole it makes a complete revolution in the same time that the earth does, and the time of revolution grows greater and greater as the latitude grows less. Exactly on the equator, the plane of oscillation does not change at all with reference to the meridian.

Day and Night.—Granted the rotation of the earth on its axis, and the alternation of day and night is fully and clearly explained. The sun may even remain fixed among the stars of the celestial vault. By the earth's turning round, all places upon

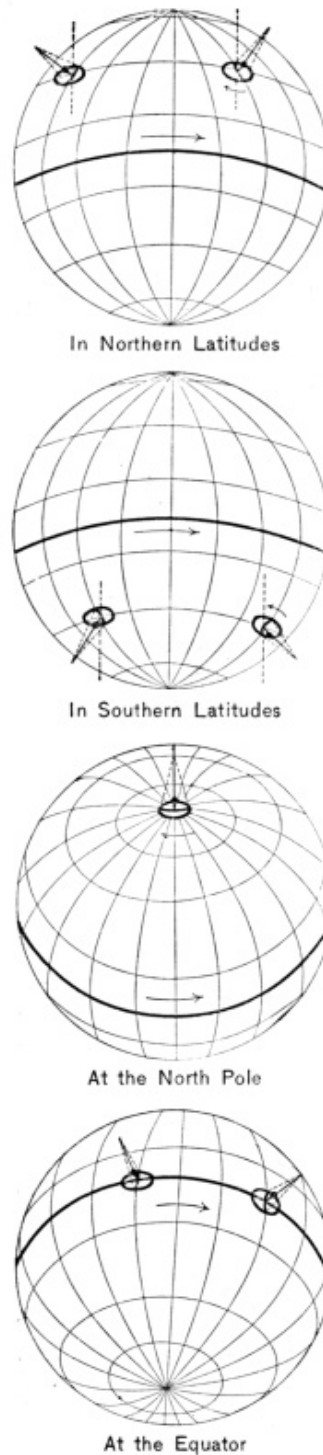

Foucault's Experimental Proof of Earth's Rotation

its surface, as New York, Chicago, and San Francisco, are carried into the sunshine and out of it alternately. From the darkness of night there comes, first, the dawn, with twilight growing brighter and brighter, then sunrise, followed by the sun rising higher and higher, till it reaches the meridian. Then it is midday, or noon. Afterward the order of occurrence is reversed,—noon, afternoon, sunset, twilight, night again. All these phenomena are, in a general way, connected by everybody with lapse of time, and progress of the hours from night to noon, and from noon back to night again. Uniform turning of the globe in the figure on this page makes this relation obvious. Count of the hours is begun at 0 or 12, when the sun is highest, and continued to 12, when the sun is lowest; and if earth were transparent as crystal, the sun could be seen through it from sunset to sunrise—crossing the lower meridian directly underneath the northern horizon at midnight.

Day and Night at the Equinoxes.—The ecliptic has been defined as the yearly path of the sun round the heavens. As it lies at an angle of $23\frac{1}{2}^\circ$ to the celestial equator, at some time each year the sun's declination must be $23\frac{1}{2}^\circ$ south, and six months from that time its declination must be $23\frac{1}{2}^\circ$ north. Midway between these points, the sun will be crossing the

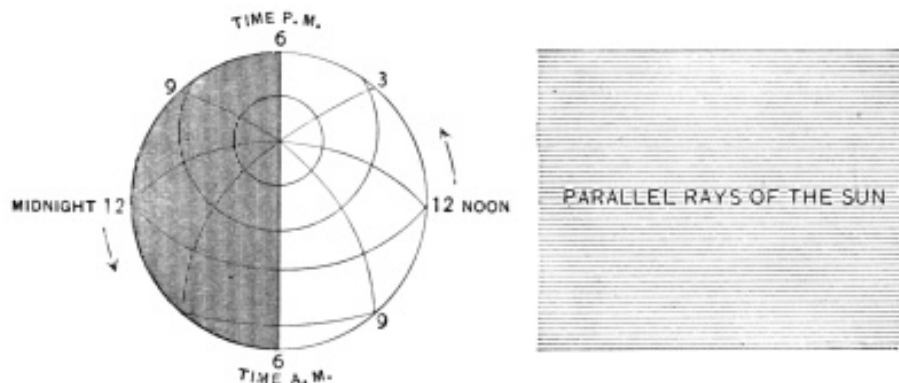

Alternation of Day and Night

equator; that is, its declination will be zero, and the sun's center will be at those points of intersection of equator and ecliptic, called the equinoxes. Why they are so called will be apparent from the figure above given; for the sun is on the celestial equator, because the earth's equator-plane extended would pass through it. The great circle of the globe which separates the day hemisphere from the night hemisphere, exactly coincides with a terrestrial meridian. Everywhere on that meridian it is 6 o'clock—6 o'clock on the half which the globe by its turning is carrying round toward the sun, and 6 o'clock P.M. on the other half which is being carried out of

sunlight. It is sunrise everywhere on the former half of this meridian, and sunset everywhere on the latter half. As daytime is the interval from sunrise to sunset, and night-time is the interval from sunset to sunrise, the day and the night are each 12 hours in length, and therefore equal. Whence the term *equinox*, from the two Latin words that mean *equal* and *night*. This equality of day and night all over the world occurs only twice during the course of each year. When the sun is crossing the equator and going northward, this happens about the 21st of March; and going southward, about the 21st of September.

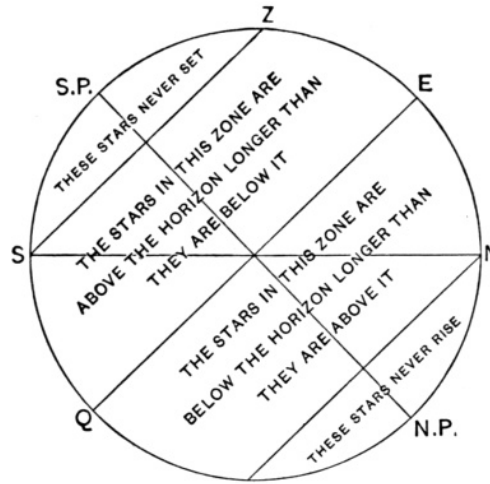

Diurnal Circles in Middle South Latitudes

Day and Night at the Solstices.—From March to September, the sun is north of the celestial equator. Therefore, at our middle latitudes he is among the stars that are above the horizon longer than they are below it, as the upper figure on page 63 clearly shows. During this period of the year, daytime in north latitudes is always longer than the night-time immediately preceding or following it. At the summer solstice the sun's declination has reached its maximum, or $23\frac{1}{2}^\circ$. The days then will be as long as possible, and the nights as short as possible. From September to March, on the other hand, the sun is south of the celestial equator, and therefore among the stars that are below the horizon longer than they are above it. During these months, then, night-time in our hemisphere is always longer than daytime. At the winter solstice the sun's declination is again a maximum, but it is $23\frac{1}{2}^\circ$ south or about midway between *E* and *S*. So that the days are then shortest, and the nights longest. But these relations of day and night to the different months are true for the northern hemisphere only.

Day and Night South of the Equator.—The figure on the current page has been suitably modified from the one on page 63, in order to show the relation of day and night at different times of the year for places of middle south latitude. By holding the page in a vertical plane, and looking west as you read, the diagrams will better correspond to actual conditions. For every degree of latitude that you pass over, in traveling southward, the north pole of the heavens goes down one degree, and the south pole rises one degree. The diagram opposite is adapted to south latitude 45° , much farther south than either Capetown,

Valparaiso, or Melbourne. The south pole of the heavens is now as far above the south horizon as it was below the south horizon, in a place of equal north latitude; and the relations of daytime to night-time are correspondingly reversed. From September to March, therefore, when the sun's declination is south, the sun is among the stars that are above the horizon longer than they are below it; so that the daytime always exceeds the night. From March to September, the sun being in north declination, the daytime clearly is shorter than the night. If at any time of the year we compare the length of the day at a given north latitude with the length of the night at an equal south latitude, we shall find them equal. Also the converse of this proposition is true.

Day and Night at the Earth's Equator.—We have considered the relation of day to night at middle north latitudes; and the explanation given holds

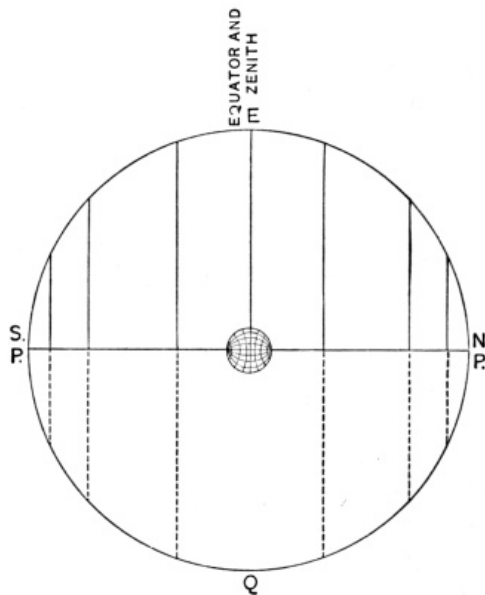

Diurnal Circles at the Equator

good for all places in the United States. Also the opposite relations, which obtain in south latitudes. It remains to consider the effect at the equator. Recalling the fact that the latitude of a place is always equal to the altitude of the visible pole of the heavens, it is clear that if the place selected is anywhere on the earth's equator, both celestial poles must be visible and coincide with the north and south points of the horizon (figure on this page). The horizon, then, must coincide with the celestial meridians, or hour circles, one after another as they seem to pass by it, in consequence of the apparent motion of the celestial sphere; and every star's diurnal circle is the same as its parallel of declination. But every hour circle divides parallels of declination in half; there-

fore, every star of the celestial sphere, as seen from a station on the earth's equator, is above the horizon 12 hours and below it 12 hours. Clearly this is true no matter what the star's declination may be; therefore it must always be true of the sun, although its declination is all the time changing. Had the early peoples who invented our astronomical terms lived upon the equator where day and night are always equal, the term *equinox* would not have signified anything unusual, and a different word would have been necessary to define the time when, and the point where, the sun crosses the celestial equator.

Sunrise and Sunset.—Refer to any ordinary almanac. The times of sunrise and sunset are given usually for two or three definite cities, north and south, or for zones of states varying widely in latitude. These are local mean times when the upper edge or limb of the true sun, as corrected for refraction, is in contact with the sensible horizon of the place, or of any place of equal latitude. The local time will not often coincide with the standard time, now almost universally used. But the correction required is simply dependent upon the difference between the longitudes of the place and of the standard meridian. If you are west of the standard meridian, for each degree add four minutes to the almanac times; if east, subtract. In verifying the almanac times by observation, remember the difference between sensible and apparent horizons.

Almanac Sunrise and Sunset at the Equinoxes.—We have seen that when the sun—that is, the sun's center—is on the equator, it rises at the same time everywhere, and that time is 6 o'clock. So, too, it sets everywhere at 6 o'clock. Why, then, do the times predicted in the almanacs differ from this? The reason is threefold, (*a*) The times of sunrise and sunset are all corrected for refraction, which at the horizon amounts to nearly $0^{\circ}.6$, or more than the sun's own breadth. As refraction always increases the apparent altitude of celestial bodies, the sun can be seen wholly above the horizon when really below it. Therefore this effect alone lengthens the daytime about five minutes, causing the refracted sun to rise about two and one half minutes earlier than the true sun, and set about the same amount later, (*b*) The almanac times of sunrise and sunset refer to the upper edge or limb of the sun, not the center. Here, again, is a cause operating in like manner with the refraction, but with an effect about half as great. (*c*) The almanac times are mean solar times of the rising and setting of the real sun. This difference between true sun and fictitious sun also displaces the times of sunrise and sunset, by the amount of the equation of time (page 97): at the vernal equinox the sun is six minutes slow; at the autumnal equinox, eight minutes fast. All three effects when combined at the vernal equinox, delay the sunset until long after six, and cause the sun to rise at the autumnal equinox long before six.

Sunrise and Sunset in Different Latitudes.—Compare the almanac times of sunrise and sunset in different latitudes on the same day. At the end of the third week of March, the times of sunrise are practically the same, no matter what the latitude. So are the sunset times. Through April, May, and June, the farther north, the earlier is sunrise and the later is sunset; the daytime is longer, and the night-time shorter. This difference on account of latitude increases until the third week in June; then it slowly diminishes until sunrise and sunset again occur at the same time regardless of latitude,

at the end of the third week in September.

Through the remaining half of the year, a change of latitude affects the time of sunrise oppositely; also the time of sunset: the farther north one goes, the later is sunrise, and the earlier is sunset. The daytime is shorter, and the night-time longer. As the year wears on, the latitude-difference of the times of both sunrise and sunset grows greater, until about Christmas time; afterward it as gradually decreases until the vernal equinox. Then, go north or south as far as one may choose, the sun will rise at the same local time; and sunset will be unaffected also.

The Midnight Sun.—The farther north one travels, the higher the pole rises toward the zenith; consequently a latitude must after a while be reached where the midsummer sun, at and near the solstice, just grazes the

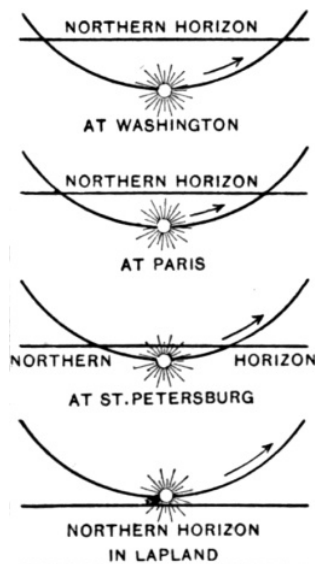

Midsummer Sun at Midnight

north horizon at midnight, and so does not set at all. The daytime period, therefore, is 24 hours long, and night-time vanishes. For the northern hemisphere, the northern parallel of $66\frac{1}{2}^{\circ}$ is this latitude. The change in the sun's daily path will be apparent in referring to the illustration; it shows how much shorter the sun's arc of invisibility below the horizon grows, as one travels north, from Washington to Paris, Saint Petersburg, and Lapland. Midnight sun is the popular name for the sun when visible in midsummer at its lower culmination underneath the pole of the heavens. The entire period of 24 hours is all daytime, and there is no night. It occurs in high northern latitudes in June; and similarly in high southern latitudes in December, the midsummer period of the southern hemisphere.

The northern extremity of the Scandinavian peninsula is known as the 'Land of the Midnight Sun,' because this weird and unusual phenomenon has been most often observed from that region.

Length of Day at Different Latitudes.—For all places on the earth's equator there is never any inequality of day and night. The farther we go from the equator, either north or south, the greater this inequality, the longer will be the days of summer, and the nights of winter. Regarding the day geometrically as the interval of time during which the center of the sun

Table 6.1: MAXIMUM LENGTH OF DAY AT DIFFERENT LATITUDES

AT LATITUDE—	GREATEST LENGTH OF DAY IS—	AT LATITUDE—	GREATEST LENGTH OF DAY IS—
0° .0	12 h.		Months
30 .8	14	67° .4	1
49 .0	16	73 .7	3
58 .5	18	84 .1	5
63 .4	20	90 .0	6
65 .8	22		
66 .5	24		

is above the sensible horizon, it is easy to calculate the greatest length of the day at any given latitude. The results are as follows and they are true for latitudes either north or south of the equator:

But these results are much modified by refraction of the atmosphere. At the time of greatest length of day in the northern hemisphere is occurring the greatest length of night in the southern hemisphere.

The Long Polar Night.—Ordinary notions of the six months of the polar night need some correction. If the actual north pole were reached, it is true that the sun would really be below the horizon very nearly six months, that is from the 20th of September to the 20th of March, while it is south of the equator; and imagining the earth to turn round on its axis inside of this atmosphere shell, as in the figure on page 81, it is clear how twilight at the pole under B continues throughout the entire 24 hours, so long as the pole is inclined away from the sun. But the duration of twilight, longer and longer as the pole is approached, is a very important factor not to be neglected. Supposing twilight to last till the sun is depressed 18° below the horizon, so long is the autumn twilight that its continuance for 2½ months would postpone the beginning of deep night till about the 1st of December; while the spring dawn, equally protracted, would begin early in January. Even at the pole, then, true night with an absolutely dark sky would be only six or seven weeks long. So much for the sun; and fortunately for the arctic explorer, the moon helps wonderfully to alleviate this dreary period. As the sun is so far south, the crescent moon at old and new, being near it, will, like the sun itself, be below the polar horizon; but during the fortnight from first quarter to last quarter, including the period of its full phase, it will shine continually above the horizon. As the moon must ‘full’ at least twice during the 1½ months when sunlight is wholly withdrawn, the period of absolute night is

reduced to about three weeks at the most. And even this will now and then be broken by brilliant auroras, especially during years of prevalent sun spots. If one retreats from the pole only 5° , or to latitude 85° north, it is quite possible that the period of utter night may vanish entirely; and, of course, still farther south, the number of hours of night illumined by neither sun nor moon must usually be exceedingly few.

The Sidereal Day.—As referred to a fixed star, the period of rotation of the earth on its axis does not vary. One such rotation is called a *sidereal day*, or day as referred to the stars. It is subdivided into 24 sidereal hours, each hour into 60 sidereal minutes, and each minute into 60 sidereal seconds. Every observatory possesses a clock regulated to keep this kind of time, and called a sidereal clock. The hours of sidereal time are always counted consecutively through the sidereal day from 0 to 24.

Approximately in the meridian, as found from the sun by the method on page 21, suspend two plumb-lines from some rigid support which does not obstruct the view south. Secure the lower ends of the plumb-lines in the exact position where they come to rest, taking care to stretch the lines taut. As soon as the stars are out, observe and record the hour, minute, and second when some bright star is in line with both of them. Its altitude should not exceed 60° above the south horizon. Use the best clock or watch at hand. The next clear night, repeat the observation on the same star; also on two succeeding evenings, setting down the day, hour, minute, and second in each case, and taking care that the running of the timepiece shall not be interfered with meanwhile, nor the plumb-lines disturbed. On comparing these observations it will be found that the star has been crossing the plumb-lines about four minutes earlier each day. If the observations were to be continued on subsequent days, we should find only the same result, and so on indefinitely: the star would soon come to the lines in bright twilight, and it could not be observed without a telescope. A few days later it would cross at sunset, and it is easy to calculate that in about three months it would cross at noon, star and sun culminating together. By this simple method is established that cardinal element in astronomy, the period of the earth's turning round on its axis. Astronomers have, to be sure, much more accurate methods than this; and the instruments employed by them are described and pictured in a later chapter, but only the details vary, the principle remaining the same.

Telling Time by the Stars.—Our next inquiry concerns the point that corresponds to 0 hours, 0 minutes, 0 seconds; that is, the beginning of the sidereal day. Having found this, our timepiece may be set to correspond; and if regulated, it will continue to keep sidereal time. As sidereal time sustains a relation to the sun which is all the while varying, it is clear that the sidereal day may begin when any star is crossing the meridian; but it is

also clear that all astronomers should agree to begin the sidereal day by one and the same star, or reference point. This is practically what they have done; and the point selected is the vernal equinox, often called 'the First of Aries,' or 'the First point of Aries'; also sometimes, 'The Greenwich of the Sky.'

The equinoctial colure passes through it; and for all stars exactly between the vernal equinox and either celestial pole, the right ascension is zero, no matter what their declination may be. Fortunately there is a bright star almost on this line, and only 32° from the north pole; so it is always above the horizon in our country, except for an hour or two each day, in some of the most southern states.

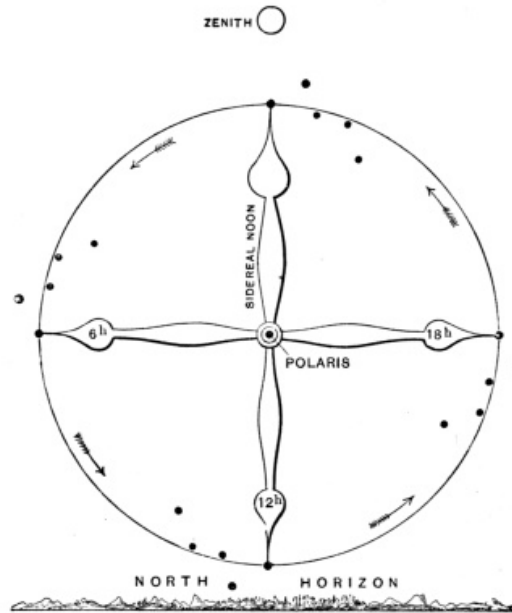

Telling the Sidereal Time by Cassiopeia

This important star is Beta Cassiopeiæ (page 59). When it is crossing the upper meridian, being as near as possible to the zenith, sidereal time is 0 h. 0 m. 0 s. and a new sidereal day begins. The relation of this conspicuous star to Polaris is shown in the above diagram. Surrounding both stars is drawn a clock-hand which may be imagined as turning round with the stars once each day. Very little practice is necessary to enable one to tell the sidereal time by the direction of this colossal clock-hand in the northern sky; but one must never fail to notice that it moves oppositely to the hour hand of an ordinary watch, and only half as fast. At 6 h. it points toward the west horizon, and at 18 h. toward the east point of the horizon; not horizontally, as represented in the figure, but downward in each case by a considerable angle varying with the latitude. Subtracting the 'sidereal time of mean noon' (page 106), gives ordinary or solar time. This operation is called 'telling time by the stars'—a method of course only approximate; but an error greater than 15 or 20 minutes will not often occur.

The Apparent Solar Day.—It was shown (page 94) how to ascertain by observation that the sun seems to be continually moving eastward among the stars. It was shown, too, that sidereal noon (noon by the stars) comes at all hours of the day and night during the progress of the year. Plainly, then,

sidereal time is not a fit standard for regulating the affairs of ordinary life; for, while it would answer very well for a fortnight or so, the displacement of four minutes daily would in six months have all the world breakfasting after sunset, staying awake all through the night, and going to bed in the middle of the forenoon. As the sun is the natural time-regulator of the engagements and occupations of humanity, he is adopted as the standard, although you will find by observing attentively that his apparent motion is beset with serious irregularities. Begin on any day of the year, and observe the sun's transit of the meridian, as you did that of a star. The instant when the sun's center is on the meridian is known as apparent noon. If you repeat the observation every day for a year, and then compare the intervals between successive transits, you will find them varying in length by many seconds, because they are all apparent solar days; they will not all be equal, as in the case of the star.

The Mean Solar Day.—By taking the average of all the intervals between the sun's transits, that is, the mean of all apparent solar days in course of the year, an invariable standard is obtained, like that from the stars themselves. In effect, this is precisely what astronomers have done, with great care and system; and for convenience, they imagine an average, or mean, sun, called the *fictitious sun*, which they accept as their standard, and then calculate the difference between its position and that of the real sun which they observe. The fictitious sun may be defined as an imaginary point or star which travels eastward round the celestial equator, not the ecliptic, at a perfectly uniform rate, making the entire circuit of the heavens in course of the year. It is easy to see that the intervals between transits of the fictitious sun must all be equal; and obviously, too, this interval is longer than the sidereal day, for this reason: if a star and the fictitious sun should cross the meridian together on one day, then on the next day the star would come to the meridian first, thereby making the sidereal day shorter than the solar day. The instant when the center of the fictitious sun is on the meridian is called mean noon. The mean solar day, therefore, may be defined as the interval between two adjacent transits of the fictitious sun over the same meridian; or the mean of all the apparent solar days of the year. It is divided into 24 mean solar hours, each hour into 60 mean solar minutes, and each minute into 60 mean solar seconds. This is the kind of hours, minutes, and seconds kept by clocks and watches in common use.

Astronomical and Civil Day.—The mean solar day is often called the astronomical day, because it begins at one mean noon and ends at the one next following. Its hours are counted continuously from 0 to 24, without a break at midnight. It is the day recognized by astronomers in observatory work and records, and by navigators in using the Nautical Almanac. The

ordinary or civil day is exactly the same in length as the astronomical day, but it begins at the midnight preceding noon of a given astronomical day, and ends at the next following midnight. As every one knows, its hours are not usually counted continuously from 0 to 24, but in two periods of 12 each. The hours of its first period are *ante meridiem*, that is, before midday, or A.M., and the hours of its second period are *post meridiem*, that is, after midday, or P.M. Therefore, civil time, P.M., of a given date is just the same as the astronomical time; if a date recorded in astronomical time between midnight and noon is to be converted into civil time, it is necessary to subtract 12 from the hours and add 1 to the days. For example:—

CIVIL DATE	ASTRONOMICAL
6 o'clock P.M., 10th November, 1899	= 1899 November 10 d. 6 h.
3 o'clock A.M., 15th December, 1899	= 1899 December 14 d. 15 h.

The astronomical date is always recorded in the order here given—year, month, day, hour, minute, second.

The Equation of Time.—Ordinary clocks and watches are regulated to run according to the average, or fictitious, sun, which makes all the days of equal length; the sun itself is sometimes ahead of this ‘fictitious sun,’ and sometimes behind it. This deviation is called the *equation of time*, and the explanation of it is given in the next chapter. The equation of time on any day varies a few seconds from year to year. It is given exactly in the Nautical Almanac; but for many purposes the following table (for 1902) may be used for any year with sufficient accuracy. In this table S means ‘sun slow’ (that is, the center of the real sun does not cross the meridian until after mean noon), and F means ‘sun fast.’

Retardation of Sunset near the Winter Solstice.—About Christmas time in our latitudes we may begin to look for the lengthening of the day, which betokens the return of spring. At first the increase is very slight, perhaps only two or three minutes in the course of a week. And it is commonly observed that the increase takes place in the afternoon half of the day; that is, the sun sets later and later each day, although its time of rising does not show much change until the middle or latter part of January. The reason of this is that sunrise and sunset are calculated for the real sun; but the times themselves are mean times, that is, time according to the fictitious sun. The real sun is fast about five minutes in the middle of December, so that the afternoon is ten minutes shorter than the forenoon. But the equation of time is diminishing rapidly; that is, the real sun is moving eastward more rapidly than the fictitious sun, and will soon coincide with it, making the equation of time zero. On account of this eastward motion of

Table 6.2: THE EQUATION OF TIME

DAY OF MONTH	JANUARY		FEBRUARY		MARCH		APRIL					
	m.	s.	m.	s.	m.	s.	m.	s.				
1	S	3	31	S	13	44	S	12	37	S	4	6
6	S	5	49	S	14	15	S	11	33	S	2	37
11	S	7	57	S	14	27	S	10	19	S	1	14
16	S	9	49	S	14	19	S	8	57	F	0	4
21	S	11	24	S	13	52	S	7	28	F	1	12
26	S	12	39	S	13	10	S	5	56	F	2	10
31	S	13	35	S	12	13	S	4	24	F	2	56
DAY OF MONTH	MAY		JUNE		JULY		AUGUST					
	m.	s.	m.	s.	m.	s.	m.	s.				
1	F	2	56	F	2	30	S	3	28	S	6	10
6	F	3	27	F	1	41	S	4	24	S	5	46
11	F	3	45	F	0	44	S	5	11	S	5	8
16	F	3	48	S	0	18	S	5	46	S	4	15
21	F	3	38	S	1	23	S	6	9	S	3	9
26	F	3	15	S	2	27	S	6	18	S	1	51
31	F	2	39	S	3	28	S	6	12	S	0	24
DAY OF MONTH	SEPTEMBER		OCTOBER		NOVEMBER		DECEMBER					
	m.	s.	m.	s.	m.	s.	m.	s.				
1	S	0	6	F	10	8	F	16	18	F	11	3
6	F	1	31	F	11	41	F	16	17	F	9	3
11	F	3	13	F	13	4	F	15	56	F	6	51
16	F	4	58	F	14	16	F	15	13	F	4	30
21	F	6	45	F	15	13	F	14	10	F	2	2
26	F	8	29	F	15	54	F	12	45	S	0	28
31	F	10	8	F	16	16	F	11	3	S	2	55

the real sun, more rapidly than usual, its mean time of setting is retarded so much that the effect begins to be apparent as a lengthening of the day, even before the sun reaches the solstice. After the solstice is passed, the sun's declination is less, and its longer diurnal arc conspires with the rapid eastward movement of the real sun; so that by the end of December both causes make the sun set a minute later each day. For a similar reason, operating at the summer solstice, the forenoon half of the day begins to shorten as early as the middle of June.

Time Keepers of the Ancients.—It is not known that the ancients had any clocks similar to ours; but they measured the lapse of time by clepsydras and sundials. Frequently also the gnomon, or pointed pillar, was used.

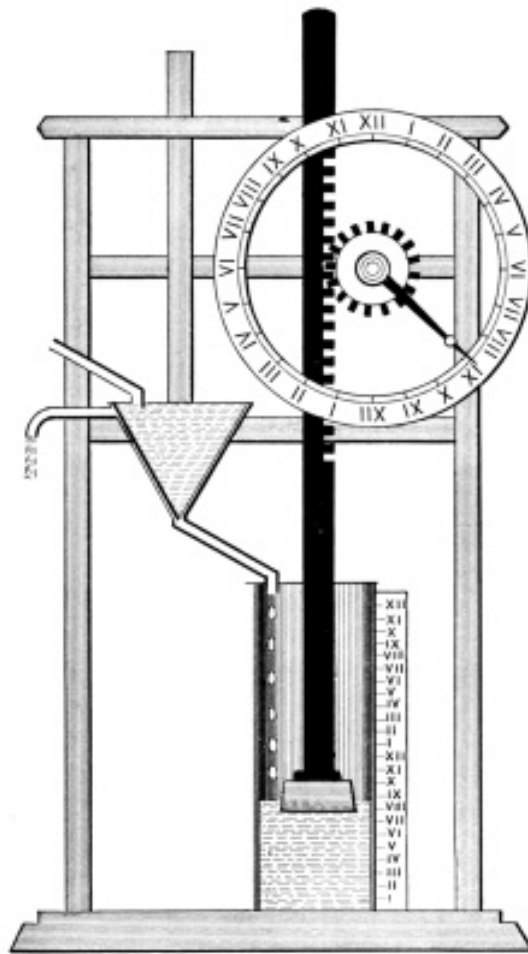

Antique Form of Clepsydra

A clepsydra is a mechanical contrivance for measuring and indicating time by means of the flow of water. The illustration shows a common form. Water is supplied freely to the conical vessel, an overflow maintaining always a given level, so that the pressure at bottom is constant. Through a small aperture and pipe, the water drops into a larger cylindrical vessel which fills very slowly. On the surface of the water in it rests a float, attached to which is an upright ratchet rod. Working into the teeth of this are the teeth of a cog wheel, and on the same arbor with it is a single hand, which revolves round the dial and marks the progress of the hours. With a contrivance of this sort, time could be told within five or six minutes. The day of the ancients, that is, the variable interval between sunrise

and sunset, was always divided into 12 hours; therefore the hours continually differed in length. By changing the aperture at bottom of the conical vessel, the clepsydra was regulated and made to keep pace with the variable hours.

Sundial Time.—The time indicated by a sundial is apparent solar time, and no ordinary clock can follow it, except by accident. Previously to the nineteenth century, however, the attempt was made to construct clocks with such compensating devices that they would gain or lose, as referred to the stars, just as the sun does. But variations in the sun's apparent motion are so complex that fine machinery necessary to follow the sun with precision could scarcely be made, even at the present day. Certainly its construction was impossible a century ago.

Early in the 19th century apparent-time clocks were generally abandoned, although in Paris they were in use as late as 1815. Elaborate sundials are still occasionally met with, but their purpose is ornamental rather than useful. In a form of sundial easily constructed, a wire is adjusted parallel to the earth's axis, and its shadow falling upon a divided circular arc parallel to the equator tells the apparent time.

To find True North quite Accurately.—As a preliminary to the arrangements for setting up any instrument in the meridian, or mounting it, as the technical expression is, true north must first be found with some accuracy. Select a window with a northern exposure, and a view down nearly to the north (sensible) horizon. From the top casing of the window, hang a long plumb-line, allowing the bob to swing freely in a basin of water. Secure it where it comes to rest, stretching the line taut. From a small table in the room hang another plumb-line in a similar manner, using fine, light-colored cord or cotton for the lines. These arrangements should be made beforehand, as in the illustration. The problem is to adjust the short line relatively to the long one, so that the vertical plane passing through the two plumb-lines shall pass also through the pole star when crossing the meridian. This vertical plane will then itself be the meridian, and must therefore intersect the horizon in the true north and south points. But we have seen that the pole star, not being exactly at the north pole, describes a very small circle of the celestial sphere once every 24 sidereal hours; therefore it must cross the meridian twice during that period. The intervals between these crossings will be nearly 12 ordinary hours. It is not at all necessary to know the exact local or ordinary time when the pole star is at the meridian; but Polaris always comes into this position whenever Mizar (Zeta Ursæ Majoris, the middle star in the handle of the Dipper) is also on the meridian. So it is only requisite to watch closely for the time when the long plumb-line passes through both these stars; then, placing the eye near the floor, to move the table carefully until the short plumb-line hangs in the same plane with the long line and both stars. Be sure that the short plumb-line hangs perfectly free and still. A candle



Finding True North without Clock or Telescope (from a Photograph by Lovell)

placed behind the observer's head will show both lines, and at the same time not obscure the stars. Then by two permanent marks in the plane of the plumb-lines, establish the meridian for convenient use. In line with Mizar and Polaris, and about as far on the opposite side of the pole, there chances to be another star, Delta Cassiopeiæ, which, therefore, can be used in the same way as Mizar itself. Through nearly the entire year, either one or the other of these stars is available for finding true north, without any reference whatever to the clock.

Times when Mizar and Delta Cassiopeiæ are on the lower Meridian.—Begin watching before the lower star comes to the meridian. It will then appear to the left of the long plumb-line hanging through Polaris. Table 6.3 shows when to begin to watch.

Table 6.3:

FOR δ CASSIOPEIÆ			FOR MIZAR		
Dec.	20	7 A.M.	July	20	5 A.M.
Jan.	20	5 A.M.	Aug.	20	3 A.M.
Feb.	20	3 A.M.	Sept.	20	1 A.M.
Mar.	20	1 A.M.	Oct.	20	11 P.M.
Apr.	20	11 P.M.	Nov.	20	9 P.M.
May	20	9 P.M.	Dec.	20	7 P.M.
June	20	7 P.M.	Jan.	20	5 P.M.

Both stars come about four minutes earlier every day, just as the south star did. During a part of June and July this method cannot be used, because it is strong twilight or daylight when Mizar and Delta Cassiopeiæ are crossing the meridian. If repeated on a subsequent night, this method of establishing the local meridian will be found sufficiently accurate for mounting any astronomical instrument. Its adjusting screws will then bring it into closer range, when the telescope can be brought into service to show the amount of deviation. If no telescope is available, a transit instrument may be made of a few common materials, and the local time found by it approximately.

A Rudimentary Transit Instrument.—The methods astronomers use in finding accurate time will be sketched in outline in Chapter IX. We here describe a method of getting the time within a few seconds by an observation of the sun. In the open air, or in a south window with a clear meridian from the south nearly up to the zenith, hang two fine plumb-lines accurately in the meridian by the method just given. In line with them, firmly attach a strong box (about 18 inches square) to the window casing, as shown in the illustration; or better, to the east or west side of a building. By sighting along the plumb-lines, run a pencil mark round the outside of the box, to indicate the meridian roughly. Bore two $\frac{3}{4}$ -inch holes in this mark, at points *A* and *B*. Also bore a third in the same plane near the middle of the upper face of the box. Over this lay a strip of sheet lead or tin, with a smooth pin hole through it, tacking it carefully so that the pin hole shall be in the plane of both plumb-lines. By sighting past these lines and through the holes *A* and *B*, draw a fine straight pencil mark on the inside of the lower face of the box, as shown, exactly in the plane of the plumb-lines. If the box is exposed to the weather, this transit line may be scratched on a strip of tin, which may then be tacked in position by sighting through the holes. *A* and *B*.

If star transits are to be observed in the open, a different arrangement of the meridian plane is necessary. Connect together the two ends of a fine brass or copper wire about 20 feet long; pass it over two points in the meridian about 6 feet apart (north one perhaps two feet above the south one); hook a heavy weight on the wire underneath, and when it stops swinging, fasten the double

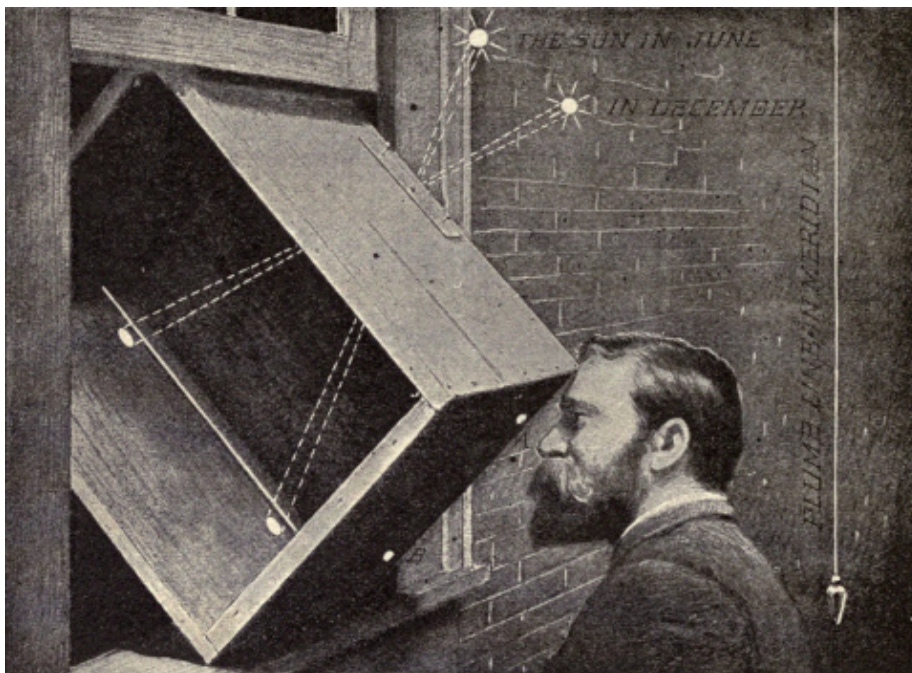

Observing the Time of Apparent Noon with the Box-transit

wire firmly. Bright stars at all meridian altitudes can be observed to cross this 'triangle transit,' with an error of only a few seconds. Comparison with a list of their right ascensions will then give the sidereal time.

Observing the Sun's Transit.—Just before noon, a small round spot of light will be seen to the west of the inside mark. It is an image of the sun itself, about $\frac{3}{16}$ inch in diameter; and it will be pretty sharply defined if the pin hole is smooth and round. The extreme positions of the image at the solstices are shown in the illustration. Watch the image as it slowly creeps toward the transit line; observe the time with a watch when its edge first touches the line: there will be an uncertainty of perhaps five seconds. Rather more than a minute later the image will be bisected by the line; observe this time also, likewise observe the time when the following edge or limb of the sun becomes tangent to the line. Take the average of the three; add or subtract the equation of time, as given in the table on page 98. The result will be local mean time, within a small fraction of a minute, provided the plumb-lines have been delicately adjusted in the meridian, and the geometric constructions of the transit box have been carefully made. A farther and constant correction will be required when the watch keeps standard time: if the place of observation is east of the standard meridian, add the amount of this difference of longitude in time; if to the west of it, subtract this difference.

Calculating the Sun's Transit.—On the 17th of February, 1906, at Amherst, Massachusetts ($2^{\circ} 28' 50'' = 9$ m. 55 s. east of the standard meridian),

the following times of transit were observed with the watch:—

	h.	m.	s.	
First limb of ☉ tangent,	12	4	8	
Sun bisected,	12	5	25	
Second limb of ☉ tangent,	12	6	33	
Mean,	12	5	22	= watch time of apparent noon.
Because sun is slow, subtract		14	14	= equation of time.
Difference,	11	51	8	= watch time of Amherst mean noon.
Add for longitude,		9	55	= east of Eastern Standard meridian.
Sum,	12	1	3	= watch time of noon at standard meridian.
Difference,	12	0	0	
	1	3		= watch fast of standard time.

How Observatory Time is found.—Recall the method of counting right ascensions of the heavenly bodies—eastward along the celestial equator from the vernal equinox to the hour circle of the body, counting from 0 h. round to 24 h. Sidereal time, as has just been shown, elapses in precisely the same way—from 0 h. 0 m. 0 s. when the vernal equinox is crossing the meridian, round to 24 h. 0 m. 0 s., when it is next on the meridian. Clearly, then, any star is on the meridian when the sidereal time is equal to its right ascension. But the right ascensions of all the brighter stars have been determined by the labor of astronomers in the past, and are set down in the *Ephemeris* and in star catalogues. Also the same is given for sun, moon, and planets. Therefore, in practice, it is the converse of this relation which concerns us in the problem of finding the time by observing the transit of a heavenly body. Simply observe the time of its transit by the sidereal clock: if this time is the same as the body's right ascension, the clock has no error. If, as nearly always happens, the time of transit differs from the right ascension, this difference is the correction of the clock; that is, the amount by which it is fast or slow. Once the correction of the sidereal clock is found, the error of any other timepiece is ascertained from comparison with it. In observatories the mean solar time is rarely found by direct observation; but it is customary to compare the mean-time clock with the sidereal clock, and then calculate the corresponding mean time by using the 'sidereal time of mean noon.'

Relation between Sidereal and Solar Time.—This relation has been found by astronomers with the utmost precision, and the quantities

concerned in it are constantly used by them in ascertaining accurate time. The true relation is this: First, find how far the fictitious sun travels eastward in one day. As it goes all the way round the celestial equator (360°) in one year, or $365\frac{1}{4}$ days, evidently in one day it travels nearly a whole degree ($59' 8''.33$, accurately). This angle, as we shall see in the next chapter, is nearly twice the apparent breadth of the sun. Now during a sidereal day an arc of 360° , or the entire equator of the heavens, passes the meridian of any given place. Therefore in a mean solar day, an arc of the equator equal to nearly 361° (accurately $360^\circ 59' 8''.33$) must pass the same meridian. From this relation we can calculate by simple proportion that 24 mean solar hours

$$= 24 \text{ h. } 4 \text{ m. sidereal time}$$

(accurately, 24 h. 3 m. 56.555 s.),

and 24 sidereal hours

$$= 23 \text{ h. } 56 \text{ m. mean solar time}$$

(accurately, 23 h. 56 m. 4.091 s.).

But we saw that the sidereal day of 24 sidereal hours is the true period of rotation on its axis. One must, therefore, guard against saying that the period of the earth's rotation on its axis is 24 hours, unless specifying that sidereal hours are meant. By the term *hour*, as ordinarily used without qualification, the mean solar hour is understood. So that the true period in which the earth turns once on its axis is, not 24 hours, but 23 h. 56 m. 4.09 s.

The Sidereal Time of Mean Noon.—At every working observatory are two clocks, the one keeping sidereal time, the other mean solar time. Let us imagine both regulated to run perfectly. About the 20th March, at mean noon, when the fictitious sun crosses the equinoctial colure, start both clocks at 0 h., 0 minutes, 0 seconds, indicated by both dials. At the next mean noon, the mean-time clock will have come

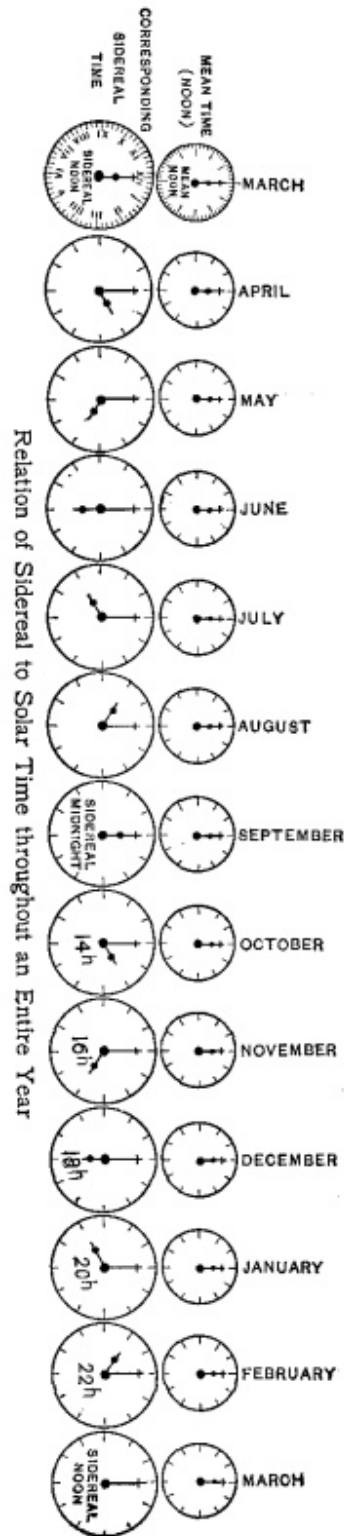

round to 0 h. 0 m. 0 s. again, marking the beginning of a new astronomical day; but the sidereal clock will indicate at the same instant 0 h. 3 m. 56.55 s., because it has gained this difference during the 24 hours. At mean noon the next following day the sidereal clock will indicate 0 h. 7 m. 53.11 s.; and so on, perpetually gaining nearly 4 m. every day. The figure just given makes this relation plain for a complete cycle of a year. The time, then, shown

Table 6.4: TABLE FOR FINDING THE SIDEREAL TIME OF MEAN NOON

TO THE MEAN TIME ON——		ADD THE FOLLOWING QUANTITY		TO THE MEAN TIME ON——		ADD THE FOLLOWING QUANTITY	
		h.	m.			h.	m.
January	1	18	45	July	1	6	40
	15	19	40		15	7	35
February	1	20	45	August	1	8	40
	15	21	40		15	9	40
March	1	22	40	September	1	10	45
	15	23	35		15	11	40
April	1	0	40	October	1	12	45
	15	1	35		15	13	40
May	1	2	40	November	1	14	45
	15	3	35		15	15	40
June	1	4	40	December	1	16	45
	15	5	40		15	17	40
July	1	6	40	January	1	18	45

(at each mean noon) by a sidereal clock perfectly adjusted, is called the ‘sidereal time of mean noon.’¹ But as no clock can be made to carry on the time with absolute accuracy, these times are, in practice, not taken from a clock, but they are calculated and published in the *Ephemeris*, a set of astronomical tables issued by the Government two or three years in advance. As the sidereal times of all the mean noons through the year are absolutely accurate for all places on the prime meridian, they can be adapted to any place by simply applying a constant correction dependent on its longitude. Clearly it is necessary to know the sidereal time of mean noon, if we desire

¹An approximate value is easily found by the above table: if the given day is not the 1st or the 15th, find the proper additive quantity by applying 4 minutes for each day before or after the nearest day given in the table.

to compare mean time with sidereal time at any instant; and this calculation of one kind of time from the other is the most frequent problem of the practical astronomer. It can be made in a minute or two, and is accurate to the $\frac{1}{100}$ part of a second.

Ascertaining Longitude.—Longitude is angular distance measured on the earth's equator from a prime meridian to the meridian of the place. In England the prime meridian of France passes through the Paris Observatory, and the prime meridian of the United States passes through the Observatory at Washington. Longitude is given in either arc or time. As the earth by turning round uniformly on its axis affords our measure of time, the meridians of the globe must pass uniformly underneath the stars; so that finding the longitude of a place is the same thing as finding how much its local time is fast or slow of the local time of the prime meridian.

Transit instruments are mounted and carefully adjusted at the two places whose difference of longitude is sought. By a series of observations (usually of transits of stars), local sidereal time at each place is ascertained. Then time at both stations is automatically compared by means of the electric telegraph, and the difference of their times is the difference of their longitudes, expressed in time. The place at which the time is faster is the farther east. If there is no telegraph line or cable connecting the two stations, indirect and much less accurate methods of comparing their local times must be resorted to. So precise is the telegraphic method that the distance of Washington from Greenwich is known with an error probably not exceeding 300 feet on the surface of the globe; and where only land lines are employed, the distance of one place from another may be found even more accurately. Usually the time will be determined and signals exchanged on a series of six or eight nights; and the entire operation of finding the longitude is called a longitude campaign.

Standard Time.—Formerly, in traveling even a few miles, one was subjected to the annoyance of changing one's watch to the local time of the place visited. The actual difference between Boston and New York is 12 minutes—between New York and Washington 12 minutes; and until within a few years each place kept only its own local time. But it was decided to establish a standard of time by which railroad trains should run and all ordinary affairs be regulated; and in November of 1883 this plan was adopted by the country at large, and time signals from Washington are now distributed throughout the United States every day at noon. The whole country is divided into four sections, or meridian belts, approximately 15 degrees of longitude in width, so that each varies from those adjacent to it by exactly an hour. The time in the whole 'Eastern' section is that

of the 75th meridian from Greenwich, making it five hours slower than Greenwich time. This 'Eastern' standard time coincides almost exactly with the local time of Utica and Philadelphia, and extends to Buffalo. Beyond that, watches are set one hour earlier, and the 'Central' section begins, just six hours slower than Greenwich time, employing 90th meridian time, which is almost exactly the local time at Saint Louis. This division extends to the center of Dakota, and includes Texas. 'Mountain' or 105th meridian time is yet another hour earlier, seven hours slower than Greenwich, and is nearly Denver local time. It extends to Ogden, Utah; and the 'Pacific' section, using 120th meridian time, is eight hours behind Greenwich, and ten minutes faster than local time at San Francisco.

This simplifies all horological matters greatly, especially the running of trains on the great railroads. While theoretically equal, these divisions are by no means so in reality, because variation is made from the straight line, in order to run each railroad system through on the same time, or make the change at great junctions. The cities just at the changing points may use either, and they make their own choice, Buffalo, for instance, choosing Eastern time, though Central would have been equally appropriate; and Ogden choosing Mountain instead of Pacific. Wherever standard time is kept, the minute and second hands of all timepieces are the same. Only the hours differ. In journeying from one meridian belt into the next, it is only necessary to change one's watch by an entire hour, setting it ahead an hour if traveling eastward, and turning it back an hour when journeying west. In this country, accurate time is distributed by time-balls, dropped at Boston, New York, Washington, and elsewhere, and by self-winding clocks controlled through the circuits of the Western Union Telegraph Company. The New York time ball is illustrated on page 8.

Standard Time in Foreign Countries.—Within very recent years, the adoption of standard time has become nearly universal among the leading governments of the world. Almost without exception, the standard meridians adopted are a whole number of hours from the prime meridian of Greenwich, and local time in different parts of the world, corresponding to Greenwich noon, is shown in the Mercator map (page 111). In a few instances, where a country lies almost wholly between two such meridians, its accepted standard of time is referred to the half-hour meridian between the two. In some European cities, particularly London and Paris, accurate time is distributed automatically from a standard clock at a central station, or observatory. The more important foreign countries where standard time is used, with their adopted standards, Table 6.5.

Travelers in these countries, therefore, have only to set their watches according to these differences of time. Italy and Spain have abolished A.M. and P.M.

Table 6.5: STANDARD TIME IN FOREIGN COUNTRIES

COUNTRY	STANDARD MERIDIAN EAST OF GREENWICH		TIME FAST OF GREENWICH		
			h.	m.	s.
England	0°	0'	0	0	0
Scotland	0	0	0	0	0
Belgium	0	0	0	0	0
Holland	0	0	0	0	0
Spain	0	0	0	0	0
France	2	20	0	9	21
Mid. Europe ..	15	0	1	0	0
East. Europe .	30	0	2	0	0
Egypt	30	0	2	0	0
South Africa ..	30	0	2	0	0
Russia	30	0	2	0	0
Turkey	30	0	2	0	0
India	82	30	5	30	0
Burma	97	30	6	30	0
Philippines ...	120	0	8	0	
W. Australia .	120	0	8	0	
Japan	135	0	9	0	
So. Australia .	142	30	9	30	
Victoria	150	0	10	0	
New So. Wales	150	0	10	0	
Queensland ...	150	0	10	0	
Tasmania	150	0	10	0	
New Zealand .	172	30	11	30	
Hawaii	*-157	30	*-10	30	
Panama	*- 75	0	*- 5	0	
Peru	*- 75	0	*- 5	0	
Chile	*- 75	0	*- 5	0	
	*west.		*slow.		

and count the hours from midnight to midnight consecutively from 0 to 24.

Uniformity of the Earth's Rotation.—It is now clear that the turning of the earth on its axis is of very great service, not only to the astronomer in making his investigations, but to mankind in general, as affording a very convenient means of measuring time. Everything is based on the absolute uniformity of this rotation. Reliance is—indeed, must be—implicit. Yet

it is possible to test this important element by comparing it with known movements of other bodies in the sky, particularly the moon, the earth, and the planet Mercury round the sun. The deviations, if any, are nearly inappreciable; and the slight slackening of its rotation at one period seems to be counterbalanced by an equal acceleration at another. So that if irregularities actually do exist, they probably cancel each other in the long run, and leave the day invariable in length. Uniformity of the earth's rotation has been critically investigated by Newcomb, and no change in the length of the day as great as $\frac{1}{1000}$ of a second in a thousand years could escape detection.

Precession of the Equinoxes.—The equinoxes have a slow motion, partly produced by the earth's turning on its axis. The ecliptic remains

invariable in position and equator and ecliptic are always inclined to each other at practically the same angle; but this motion of the equinoxes is a gliding of equator round ecliptic, and is called *precession*. The equinoxes travel westward about $50\frac{1}{4}''$ annually; so that in rather less than 13,000 years, the vernal equinox will have slipped round to the position formerly occupied by the autumnal equinox. In 25,900 years precession completes an entire cycle, both equinoxes returning to their position at the beginning of it.

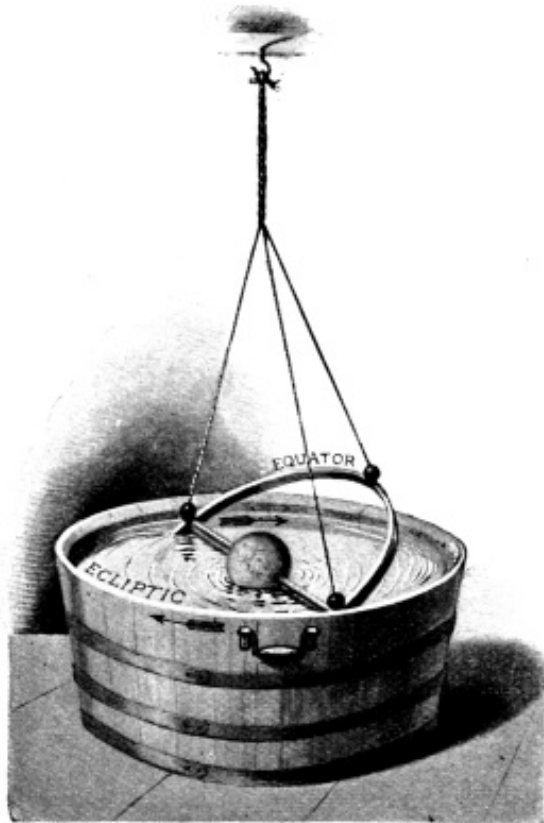

A Model to illustrate Precession

Precession is so important in astronomy that the phenomenon should be perfectly understood. Over a tub nearly filled with water, suspend a barrel hoop by three cords, two of which, equal in length, are attached to the hoop at the extremities of a diameter. The third cord, a few inches shorter than the other two, is tied to the hoop midway between them. Fasten three weights

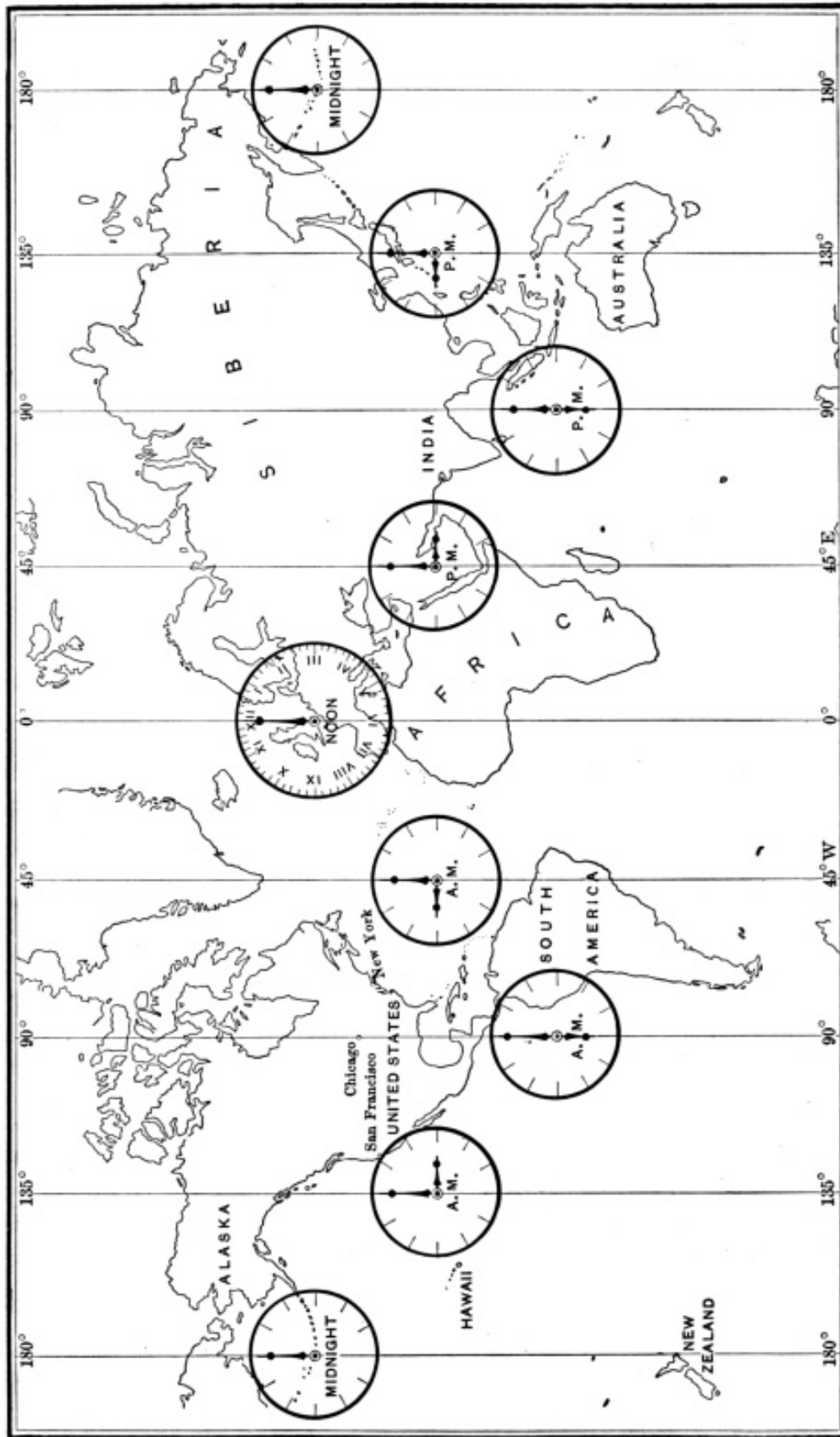

Time all over the World when it is Noon at Greenwich

of about one pound each at the same points. Gather the three cords together into one, at a few feet above the hoop, and tie them to a right-hand-twisted cord a few feet long. To represent the earth, with axis perpendicular to the hoop, secure any common spherical object in the center of the hoop, by a crosspiece nailed to hoop as indicated. Suspend the whole by the twisted cord as shown in the picture, lowering it until the hoop is immersed to the knots of the two long cords. These represent the equinoxes, the hoop itself the celestial equator, and the surface of water in the tub stands for plane of ecliptic. Adjust the shorter cord so that the hoop shall be tilted to the water about $23\frac{1}{2}^\circ$. Now release the hoop, and it will twirl round clockwise; the motion of the two opposite knots will correspond to precession of the equinoxes, and represent the long period of precession, 25,900 years in duration. This motion of the signs of the zodiac (in the direction Aries, Pisces, Aquarius), is represented by the arrow in the illustration on page 58. Pole of ecliptic is *E*, and round it as a center moves *P*, the earth's pole, in a small circle, *PpSV*, 47° in diameter.

Effects of Precession.—On account of precession, right ascensions and declinations of stars (being referred to the equator as a fundamental plane) are continually changing. Precession of the equinoxes was first found



Vernal Equinox in Taurus (B.C. 2200)

out by Hipparchus (B.C. 150). About B.C. 2200, the vernal equinox was near the Pleiades as in the adjacent figure. Since that time it has traveled back, or westward, about 60° , through Aries, until now it is in the western part of Pisces, as on the next page. So the signs of the zodiac do not now correspond with constellations which bear

the same names, as they did in the time of Hipparchus; and the two systems are becoming more and more separated as time elapses. Because the direction of earth's axis in space is changing, the north celestial pole is slowly moving among the stars, in a small circle whose center is the north pole of the ecliptic; and it will complete its circle in the period of precession itself. That important star Polaris, our present north star because now so near the intersection of earth's axis prolonged northward to the sky, has not always been the pole star in the past, nor will it always be in the future. If circumpolar stars were photographed in trails, as on page 30, at intervals of a few hundred years, the curvature of arcs traversed by a given star would change from time

to time. About 200 years hence, the true north pole will be slightly nearer Polaris than it now is, and afterward the pole will retreat from it. About B.C. 3000, Alpha Draconis was the pole star; and 12,000 years hence, Vega (Alpha Lyræ) will enjoy that distinction. Regarding positions of stars as referred to the ecliptic system, their latitudes cannot change, because ecliptic itself is fixed. But longitudes of stars must change, much as right ascensions do, because counted from the moving vernal equinox. Besides rotation about its axis, the earth has another motion of prime importance, which we shall now discuss.



Vernal Equinox now in Pisces

Chapter VII

The Earth Revolves Round the Sun

Hitherto explanation has been given only of that apparent motion of the heavenly bodies which is common to all—a rising in the east, crossing the meridian, and setting in the west. Although this motion was regarded as real in the ancient systems of astronomy, we have seen that it is satisfactorily explained as a purely apparent motion, due to the simple turning round of the earth on its axis once each day. Now we shall consider an entirely different class of celestial motions; we know that they take place because our observations show that none of the bodies which are tributary to the sun are stationary in the sky. This point will be fully dwelt upon in a subsequent chapter on the planets. On the contrary, all seem to be in motion among the stars; at one time forward or eastward, and at another backward or toward the west. All through the period of the infancy of astronomy, a fundamental mistake was made; too great importance was attached to the earth, because men dwell upon it, and it seemed natural to regard it as the center about which the universe wheeled. Centuries of investigation were required to correct this blunder; and true relations of the celestial mechanism could be understood only when real motions had been thought out and put in place of apparent ones. The earth was then forced to shrink into its proper and insignificant rôle, as a planet of only modest proportions, itself obedient in motion to the overpowering attraction of the sun.

The Sun's Apparent Annual Motion.—First, let us again observe the sun's seeming motion toward the east. Soon after dark, the first clear night, observe what stars are due south and well up on the meridian. A week later, but at the same time of the evening, look for the same stars; they will be found several degrees west of the meridian. Why the change? These stars, and all the others with them, seem to have moved westward toward the sun; or what is the same thing, the sun must have moved eastward toward these stars. But while this appears to be a motion of the sun, we shall soon see that it is really a motion of the earth round the sun. If our

globe had no atmosphere, the stars would be visible in the daytime, even close beside the sun; and it would be possible, directly and without any instruments, to see him approach and pass by certain stars near his path from day to day. A few observations would show that the sun seems to move eastward about twice his own breadth, that is 1° , every day. His path among the stars would be found to be practically the same from year to year. This annual path of the sun among the stars is called the *ecliptic*, and invariability of position has led to its adoption by astronomers from the earliest times, as a plane of reference. Its utility as such has already been considered in Chapters II and III; it is the fundamental plane of the ecliptic system.

Sun's Apparent Motion really the Earth's Motion.—What causes that apparent motion of the sun just described?

Select a room as large as possible in which there is a tall lamp. Place this in the center of the room, and walk around it counter-clockwise, facing the lamp all the time; notice how it seems to move round among and pass by the objects on the wall. It appears to travel with the same angular speed that you do, and in the same direction. Now imagine yourself the earth, the lamp to be the sun, and the objects on the wall the fixed stars. The horizontal plane through the lamp and the eye will represent the ecliptic; one complete journey round the lamp will correspond to a year.

A simple experiment of this character will convey a clear idea of the true explanation of the sun's apparent motion: that great luminary is himself stationary at the center of a family or system of planets, of which our earth is merely one; and our globe by traveling round the sun once each year causes him to appear to move. If, however, it is not clear how the earth's motion is the true cause of the sun's seeming to describe his annual arc round the ecliptic, put yourself in place of the lamp and have some one carry the lamp round you, counter-clockwise. Meanwhile keep your eye constantly upon the lamp, and observe that it seems to move round on the wall in just the same direction and at the same speed as when the lamp was stationary and you walked around it.

Earth's Orbit the Ecliptic Plane.—The real path which one body describes round another in space is called its *orbit*. The path our globe travels round the sun each year is called the earth's orbit. We cannot see the stars close to the sun, nor observe his position among them each day; but practically the same thing is done by means of instruments in government observatories. While these observations of the sun's position are going on from the earth, imagine a similar observatory on the sun, at which the earth's positions among the stars are recorded at the same times.

Every earth observation of the sun will differ from its corresponding sun observation of the earth by exactly 180° . But the earth observations of the sun are all included in that great circle of the sky called the ecliptic, therefore all the sun-observed positions of the earth (that is, the earth's own positions in space) must also be in the ecliptic. They are therefore included in a plane.



6 A.M.—Earth traveling up

Which Way is the Earth traveling?—In attempting to pass from a conception of the earth at rest as it seems, to the earth moving round the sun as it really is, no help can be greater than the frequent pointing toward the direction in which the earth is actually traveling. The gradual and regular variation of this direction with the hours of day and night, and its relation to fixed lines in a room or building, will soon impress firmly upon the mind the great truth of the earth's



12 Noon—Earth traveling Westward

annual motion round the sun.

Extend the arms at right angles to each other as in the illustration. Swing round until the left arm is pointed toward the sun, whether above or below the horizon. This arm will then be in the plane of the ecliptic. Still keeping the arms at right angles, bring the right arm as nearly as may be into the plane of the ecliptic at the time. This may be done as already indicated on page 59. The right arm will then be pointing in the direction in which the earth is journeying in space. The right arm holding the ball and arrow is always pointing in the direction of earth's motion through space, relatively to the local horizon in the latter part of September:

- (1) at 6 A.M., upward toward a point about 20° south of the zenith;
- (2) at noon, toward the northwest, at an altitude of about 10° ;



12 Midnight—Earth traveling Eastward

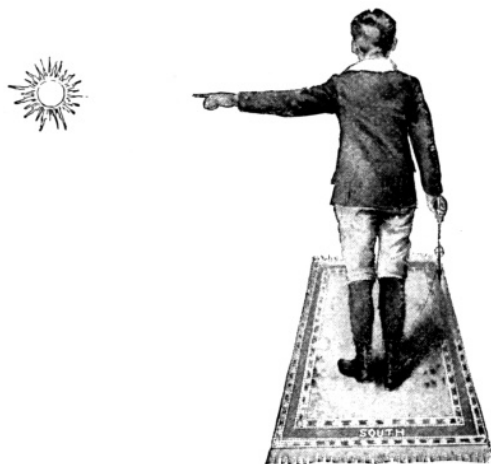

6 P.M.—Earth traveling Downward

- (3) at 6 P.M., downward to a point about 20° below the north horizon;
- (4) at midnight, toward the northeast at an altitude of about 10° .

It is apparent that the direction of the earth's motion is simply the direction of a point whose celestial longitude is 90° less than that of the sun. This moving point is often called the earth's goal, or the *apex of the earth's way*.

Change in Absolute Direction of Earth's Motion.—In an early chapter was explained how east and west, north and south at a given place are always changing with the earth's turning on its axis, and that it is necessary to think of these directions as curving round with the surface of the earth. We saw, too, that the same relations exist with reference to the cardinal

points of the celestial sphere, so that east, for example, in one part of the heavens, is the same absolute direction as west on the opposite part of the celestial sphere. In precisely the same way we have now to think of the absolute direction of earth's movement round the sun as continually changing in space. If at one moment there is a star exactly toward which the earth is traveling, three months before that time and three months afterward we shall be going at right angles to a line from the sun to that star; and six months from the given time we shall be traveling exactly away from it. In the chapter relating to the stars it will be shown how this motion of the earth in space can actually be demonstrated by a delicate observation with an instrument called the spectroscope.

Earth's Orbit an Ellipse.—The angle which the sun seems to fill, as seen from the earth, is called the sun's apparent diameter. Measures of this angle, made at intervals of a few days throughout the year, are found to differ very materially. It is not reasonable to suppose that the size of the sun itself varies in this manner. What, then, is the explanation? Obviously the sun's distance from us, or, what is the same thing, our distance from him, is a variable quantity. The earth's orbit, then, cannot be a circle, unless the sun is out of its center. But the observations themselves, if carefully made, will show the true shape of the orbit. It is not necessary to know what the real distance of the sun is, because we are here concerned with relative distance merely, nor need the observations be made at equal intervals. In an early chapter we saw that the apparent size of a body grows less as its distance becomes greater. Apply this principle to the measures of the sun.

Plot the observations by drawing radial lines at angles corresponding to various directions in the ecliptic when observations of the sun's breadth were made. Cut off the radial lines at distances from the radial point proportional to the observed diameters, and then draw a regular curve through the ends of the radial lines. On measuring this curve, it is found that it deviates only slightly from a circle, but that it is really an ellipse, one of whose foci is the radial point. Earth's orbit round the sun, then, is an *ellipse*, with the sun at one focus.

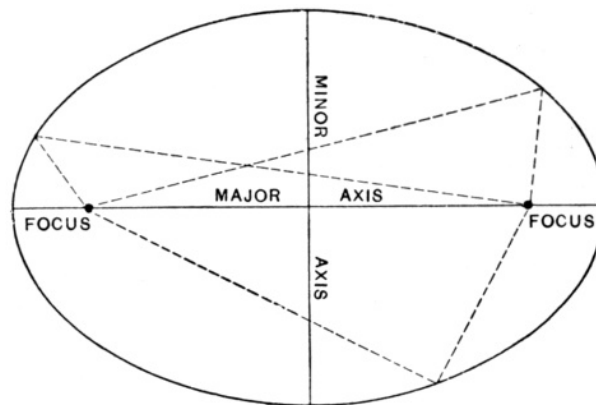

Ellipse, Foci, Axes, and Radii Vectores

Earth's orbit round the sun, then, is an *ellipse*, with the sun at one focus.

The Ellipse.—The ellipse is a closed plane curve, the sum of the distances from every point of which, measured to two points within the curve, is a constant quantity. This constant fixes size of the ellipse, and is equal to its longer axis, or major axis (figure on the preceding page). At right angles to the major axis, and through its center is the minor axis. The two determining points are called foci, and both of them are situated in the major axis, at equal distances from the center of the ellipse. Divide the distance from the center to either focus by the half of the major axis, and the quotient is called the *eccentricity*. This quantity fixes the form of the ellipse. If the foci are quite near the center, the eccentricity becomes very small, and the curve approaches the circle in form. If the center and both foci are merged in a single point, evidently the ellipse becomes an actual circle. This is called one limit of the ellipse. But if the foci recede from the center and approach very near the ends of the major axis, then the corresponding ellipse is exceedingly flattened; and its limit in this direction becomes a straight line.

Limits of the Ellipse.—These two limits are easy to illustrate, practically, by looking at a circular disk (*a*) perpendicularly, and (*b*) edge on. In tilting it 90° from one position to the other, the ellipse passes through all possible degrees of eccentricity. The orbits of the heavenly bodies embrace a wide range of eccentricity. Some of them are almost perfectly circular, and others very eccentric. In drawing figures of the earth's orbit, the flattening is necessarily much exaggerated, and this fact should always be kept in mind. The eccentricity of the earth's orbit is about $\frac{1}{60}$; that is, the sun's distance from the center of the orbit is only $\frac{1}{60}$ part of the semi-major axis. If it is desired to represent the earth's orbit in true proportions on any ordinary scale, the usual way is to draw it perfectly circular, and then set the focus at one side of the center, and distant from it by $\frac{1}{60}$ the radius. If the center is obliterated, a well-practiced eye is required to detect the displacement of the focus from the center. And as we shall see, many of the celestial orbits are even more nearly circular than ours.

How to draw an Ellipse.—The definition of an ellipse suggests at once a practical method of drawing it. Lay down the major axis and the minor axis. From either extremity of the latter, with a radius equal to half the major axis, describe a circular arc cutting the major axis in two parts. These will be the foci. Tie together the ends of a piece of fine, non-elastic twine, so that the entire length of the loop shall be equal to the major axis added to the distance between the foci. Set two pins in the foci, place the cord around them, and carry the marking point round the pins, holding the cord all the time taut. The point will then describe an ellipse with sufficient accuracy.

Lines and Points in Elliptic Orbits.—The earth is one of the planets, and in treating of them the laws of their motion in elliptic orbits will be given. In a still later chapter

the reason why they move in orbits of this character will be explained. Here are defined such terms as are necessary to understand in dealing with the earth. Only one of the foci of the orbit need be considered. In that one the primary body is always located. Any straight line drawn from the center of that body, as *S*, to any point of the ellipse, as *E*, is called a *radius vector*. The longest radius vector is drawn to a point called *aphelion*; the shortest radius vector, to perihelion. Together these two radii vectores make up the major axis of the orbit. Perihelion is often called an apsis; aphelion also is called an apsis. A line of indefinite length drawn through them, or simply the major axis itself unextended, is called the *line of apsides*. Imagine the point where the line of apsides, on the perihelion side, meets the celestial sphere to be represented by a star. The longitude of that star, or its angular distance measured counter-clockwise from the first of Aries, is technically called the longitude of perihelion. This is 100° in the case of the earth. The longitude of perihelion increases very slowly from year to year; that is, the apsides travel eastward, or just opposite to the equinoxes. But, slow as the equinoxes move, the apsides travel only one fourth as fast.

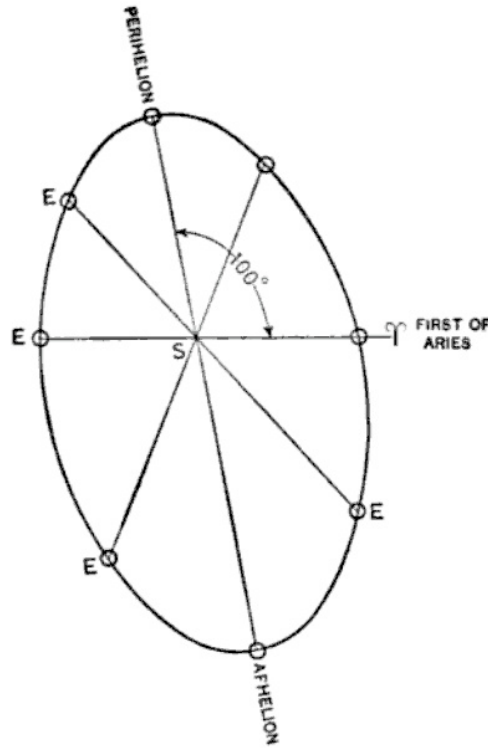

Earth's Orbit (Ellipticity much exaggerated)

Earth's Orbit in the Future.—Not only does the line of apsides revolve, but the obliquity of the ecliptic (page 130) changes slightly, and even the eccentricity of the earth's orbit varies slowly from age to age. These facts were all known a century or more ago; but with regard to the eccentricity, it was not known whether it might not tend to go on increasing

for ages. Should it do so, the earth would be parched at every perihelion passage, and congealed on retreating to aphelion: it seemed among the possibilities that all life on our planet might thus be destined to come to an end, although remotely in the future. But in the latter part of the eighteenth century, a great French mathematician, La Grange, discovered that although the earth's orbit certainly becomes more and more eccentric for thousands of years, this process must finally stop, and it then begins to approach more and more nearly the circular form during the following period of thousands of years. The eccentricity, now near the average value, will be decreasing for the next 24,000 years. He showed, too, that the obliquity of the ecliptic simply fluctuates through a narrow range on either side of an average value. These slight changes are technically called secular variations, because they consume very long periods of time in completing their cycle. The mean or average distance, and with it the time of revolution round the sun, alone remains invariable. As we know this period for the earth, and the eccentricity of its orbit together with the location of its perihelion point, by calculating forward or backward from a given place in the sky on a given date, we can find the position of the sun (and therefore of the earth in its orbit) with great accuracy for any past or future time.

Earth's Motion in Orbit not Uniform.—Refer back to the observations of the sun's diameter by which it was shown that our orbit round

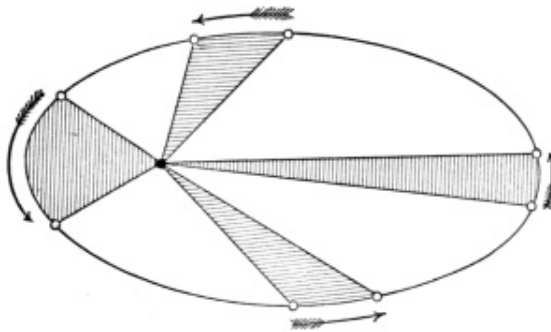

Radius Vector sweeps Equal Areas in Equal Times

the sun is not a circle, but an ellipse. Had they been made at equal intervals of time, it would at once have been seen, on plotting them, that the angles through which the radius vector travels are not only unequal, but that they are largest at perihelion, and smallest at aphelion. By employing mathematical processes, it is easy to show from the observations of diameter, connected with the corresponding angles, that a definite

law governs the motion of the earth in its orbit. Kepler was the first astronomer who discovered this fact, and from him it is called Kepler's law. It will seem remarkable until one apprehends the reason underlying it. The law is simply this: The radius vector passes over equal areas in equal times. That the figure on the current page may illustrate this, an ellipse is drawn of much greater eccentricity than any real planetary orbit has. What the

law asserts is this: Suppose that in a given time, say one month, the earth in different parts of its orbit moves over arcs equal to the arrows; then the lengths of these arrows are so proportioned that their corresponding shaded areas are all equal to each other. And this relation holds true in all parts of the orbit, no matter what the interval of time.

The Unit of Celestial Measurement.—By taking the average or mean of all the radii vectores, a line is found whose length is equal to half the major axis. This is called the *mean distance*. The mean distance of the center of the earth from the center of the sun we shall next find from the velocity of light. This distance is 93,000,000 miles, and it is the unit of measurement universally employed in the astronomy of the solar system. Consequently, it is often called *distance unity*; and as other distances are expressed in terms of it, they have only to be multiplied by 93,000,000, to express them in miles also.

Trying to conceive of this inconceivable distance is worth the while. Illustrations sometimes help. Three are given: (*a*) If you had silver half dollars, one for every mile of distance from the earth to the sun, they would fill three ordinary freight cars. If laid edge to edge in a straight line, they would reach from Boston to Denver. (*b*) It has been found by experiment that the electric wave in ordinary wires travels as far as from New York to Japan and back in a single second (about 16,000 miles). If you were to call up a friend in the sun by telephone, the cosmic line would be sure to prove more exasperating than terrestrial ones sometimes are; for even if he were to respond at once, you would have to wait $3\frac{1}{4}$ hours. (*c*) Suppose that as soon as Abraham Lincoln was born, he could have started for the sun on a fast express train, like the one illustrated on page 39, which can make long runs at the rate of 60 miles an hour. Suppose, too, that it had been keeping up this speed ever since, day and night, without stopping. A long, long time to travel continuously, but his body would still be on the road, for the train would not reach the sun till 1984.

Finding the Velocity of Light by Experiment.—Light travels from one part of the universe to another with inconceivable rapidity. Light is not a substance, because experiment proves that darkness can be produced by the addition of two portions of light. Such an experiment is not possible with substances. All luminous bodies have the power of producing in the ether a species of wave motion. The ether is a material substance which fills all space and the interstices of all bodies. It is perfectly elastic and has no weight. As light travels by setting up very rapid vibrations of the particles of the ether, it is usually called the luminiferous ether. Different from the vibrations of the atmospheric particles in a sound wave, light waves travel by vibrations of the ether athwart the course of the ray. The velocity of

wave transmission is called the velocity of light. It is not difficult to find by actual experiment.

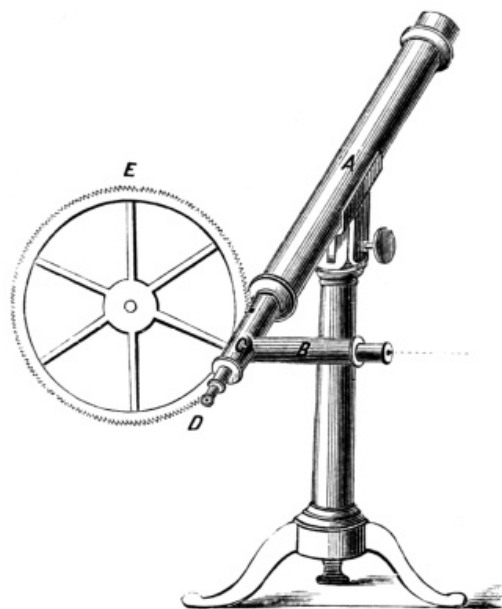

Finding Velocity of Light

One method is illustrated by the figure. A ray of light is thrown into the instrument at *B*, in the direction of the dotted line. It is reflected at *C*, and goes out of the telescope *A* to a distant mirror, which reflects it directly back to the telescope again, and the observer catches the return ray by placing the eye at *D*. In the field of the telescope are the teeth of a wheel *E*, through which outgoing and returning rays must pass. With the wheel at rest, the return ray is fully seen between the teeth of the wheel. Whirl the wheel rapidly. While the direct ray is going out to the mirror and coming back to the wheel, a tooth will have moved partly over its own width, and will therefore partly shut off the ray, so that the star

appears faint instead of light. Whirl the wheel faster, and the return ray becomes invisible. Keep on increasing the velocity of the wheel, and the star again reappears gradually. And so on. More than twenty disappearances and reappearances can be observed. The speed of the wheel is known, because its revolutions are registered automatically by the driving apparatus (omitted in the figure); and the distance of the mirror from the wheel can be accurately measured, so that the velocity of light can be calculated.

This and other similar experiments have often been repeated by Cornu, Michelson, Newcomb, and others, in Europe and America; and the result of combining them all is that light waves, regardless of their color, travel 186,300 miles in a second of time.

Size of the Earth's Orbit.—Where matters pertaining to elementary explanation are simplified by so doing, it is evident that the earth's orbit may be regarded as a circle. From several hundred years' observation of the moons which travel round the planet Jupiter, it has been found that reflected sunlight by which we see them consumes 998 seconds in traveling

across a diameter of the earth's orbit (page 305). So that $\frac{1}{2} \times 998 \times 186,300$ is the radius of that orbit, or the mean distance of the sun. This distance is 93,000,000 miles, just given. Earth is at perihelion about the 1st of January each year, and on account of eccentricity of our orbit we are about 3,000,000 miles nearer the sun on the 1st of January than on the 1st of July. Our globe travels all the way round this vast orbit, from perihelion back to perihelion again, in the course of a calendar year. Clearly, its motion must be very swift. Hold a penny between the fingers at a height of four feet. Suddenly let it drop: in just a half second it will reach the floor. So swiftly are we traveling in our orbit round the sun, that in this brief half second we have sped onward $9\frac{1}{4}$ miles. And in all other half seconds, whether day or night, through all the weeks and months of the year, this almost inconceivable speed is maintained.

Earth's Deviation from a Straight Line in One Second.—As our distance from the sun is approximately 93,000,000 miles, the circumference of our orbit round him (considered as a circle) is 584,600,000 miles. But as we shall see in a later paragraph, the earth goes completely round the sun in one sidereal year, or 365 d. 6 h. 9 m. 9 s.; therefore in one second our globe travels through space $18\frac{1}{2}$ miles. In that short interval, how far does our path bend away from a straight line, or tangent to the orbit? Suppose that in one second of time, the earth would move in a straight line from *M* to *N*, if the sun exerted no attraction upon us. Because of this attraction, however, we travel over the arc *Mn*. The length of this arc is $18\frac{1}{2}$ miles, or about $0''.04$ as seen from the sun; and as this angle is very small, the arc *Mn* may be regarded as a straight line, so that *MnU* is a right angle. Therefore

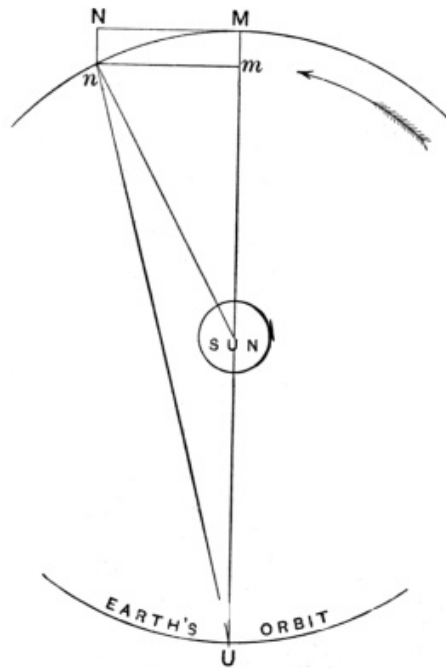

Earth's Deviation in One Second

$$MU : Mn :: Mn : Mm.$$

But *MU* is double our distance from the sun; therefore *Mm* is 0.119 inch, which is equal to *Nn*, or the distance the earth falls from a straight line in one second. So that we reach this very remarkable result: The curvature of

our path round the sun is such that in going $18\frac{1}{2}$ miles we deviate from a straight line by only $\frac{1}{9}$ of an inch.

Reason for the Difference between Solar and Sidereal Day.—The real reason why the sidereal day is shorter than the solar day can now be made clear. The figure is a help. If earth were not moving round the sun, but standing still in space, one sidereal day would be the time consumed by a point on the equator, A , in going all the way round in direction of the



Sidereal and Solar Day compared

lower arrows, and returning to the point of starting. But while one sidereal day is elapsing, the earth is speeding eastward in its orbit, from O to O' . Sun and star were both in the direction AS at the beginning; but after the earth has turned completely round, the star will be seen in the direction $O'A$, which is parallel to OA , because OO' is an indefinitely small part of the whole distance of the star. This marks one sidereal day. The sun, however, is in the direction $O'S$; and the solar day is not complete until the earth has turned round on its axis enough farther to bring A underneath S . This requires nearly four minutes; so the length of the solar day is 24 hours of solar time, while the sidereal day, or real period of the earth's rotation, equals 23 h. 56 m. 4.09 s. of solar time. Also in the ordinary year of $365\frac{1}{4}$ solar days, there are $366\frac{1}{4}$ sidereal days.

Sun's Yearly Motion North and South.—You have found out the eastward motion of the sun among the stars from the fact that they are observed to be farther and farther west at a given hour each night. You

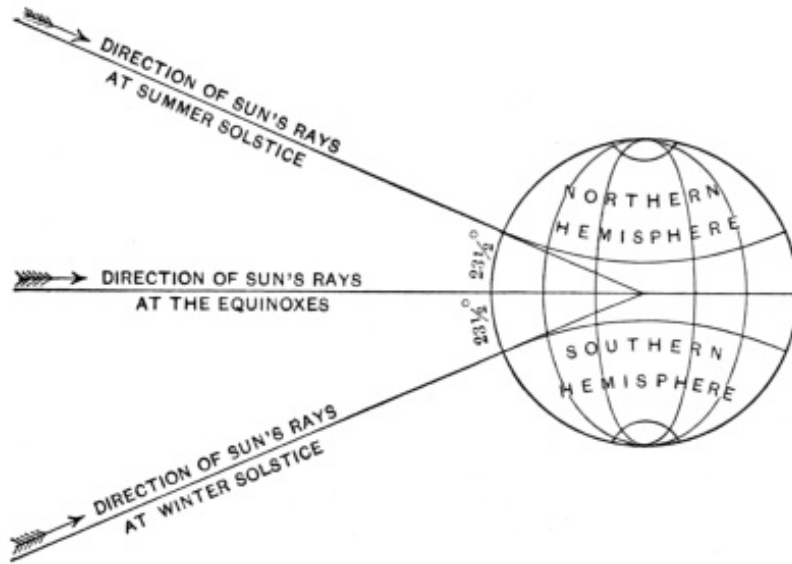

Direction of Sun's Rays at Equinoxes and Solstices

must next ascertain the nature of the sun's motion north and south. The most convenient way will be to observe where the noon shadow of the top of some pointed object falls. Begin at any time of the year; in autumn, for example. This shadow will grow longer and longer each day; that is, the noonday sun is getting lower and lower down from the zenith toward the south. How low will it actually go? And when is this epoch of greatest length of the shadow? Even the crudest observation shows that the noonday shadow will continue lengthening till the 20th of December; but the daily increase of its length just before that date will be difficult to observe, it is so very slight. Then for a few days there will be no perceptible change; in so far as motion north or south is concerned, the sun appears to stand still. As this circumstance was the origin of the name *solstice*, notice that it indicates both time and space: the winter solstice is the time *when* (or the point in the celestial sphere *where*) the sun appears to 'stand still' at its greatest declination south. The time is about the 20th of December. Not until after Christmas will it be possible to observe the sun moving north again; and then, at first, by a very small amount each day.

The Sun in Midwinter.—For the sake of comparison with other days in the year, let us photograph (at noon on a bright day near the winter

solstice) some familiar object with a south exposure; for example, a small and slender tree, with its shadow (on this page).

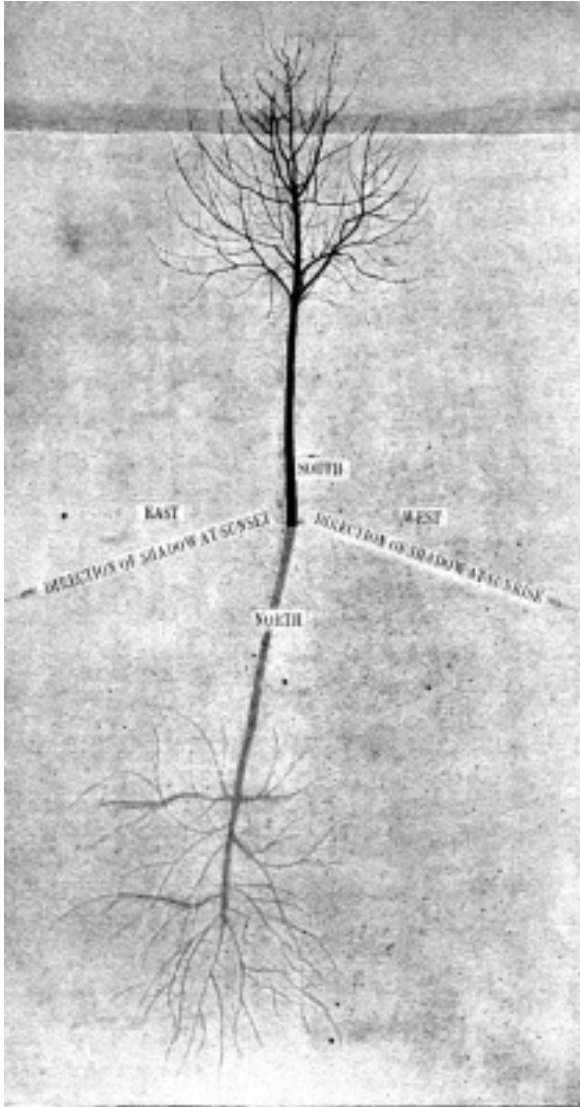

Midwinter Shadows Longest

shorter tree is than shadow, because the sun culminates low. So far north does the shadow of the tree fall that a part of it actually reached the house where the camera stood. Verify the northeast-by-east direction of the sunset shadow of the tree; and the corresponding direction (north-west-by-west) of its sunrise shadow, also; for the sun will now rise at a more available hour than in mid-summer. Notice, too, how sharply defined the shadow is, near the trunk of the tree; and how ill-defined the shadows of the branches are. This is because the sun's light comes from a disk, not a point; the shadows are penumbral, that is, not quite like dark shadows; and they grow more and more hazy, the farther the surface upon which they fall.

The Sun's Yearly Motion North.—Onward from the beginning of the year, continue to watch the sun's slow march northward. With each day its noontime shadow will grow shorter and shorter.

Watch the point in the western horizon where the sun sets; with each day this, too, is coming farther and farther north. Note the day when the sun sets exactly in the west; this will be about the 20th of March. As the sun sets due west, evidently it must previously have risen due east; therefore the great circle of its diurnal motion (which at this season is the equator) must be bisected by the horizon. Day and night, then, are of equal length.

The vernal equinox is the time when (or the point where) the sun going northward crosses the celestial equator.

The Sun in Midsummer.—Now begin again the observations of the noontime shadow. Shorter and shorter it grows and perceptibly so each day.

But it will be noticed that the difference from day to day is less than the daily increase of length six months before. That is simply because the shadows fall nearer the tree, and are measured more nearly at right angles to the sun's direction than they were in the autumn and winter. The azimuth of its setting will increase. How many weeks will the length of the shadow continue to decrease? How short will it actually get? About the middle of June, it will be almost impossible to notice any further decrease in the shadow's length, and on 20th June we may again photograph the same tree. But how changed! The short shadow of its trunk is all

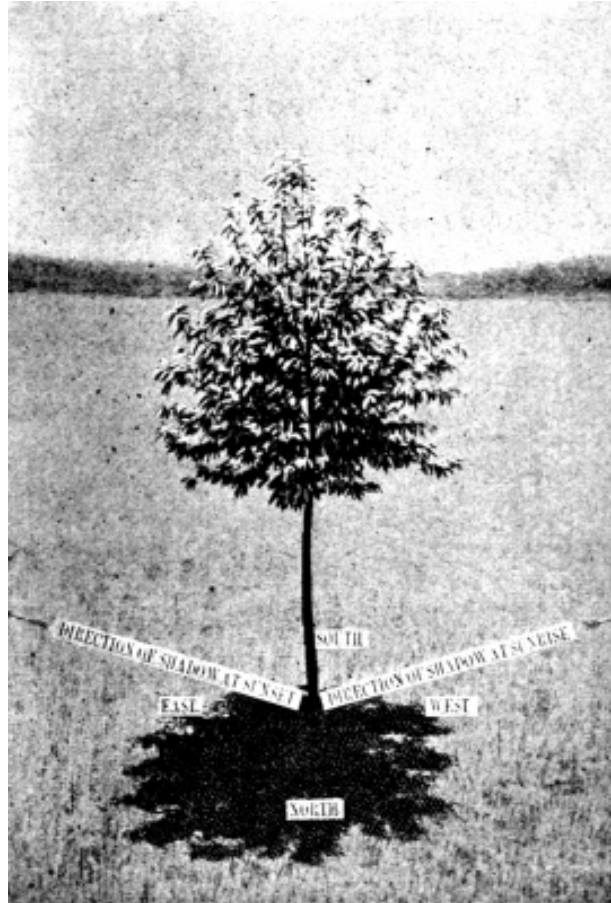

Midsummer Shadows Shortest

merged in the shadow of the foliage where it falls upon the lawn. Points of the compass alone are unchanged. Here again at midsummer, the sun stands still, and there is a second solstice. Summer solstice is the time when (or the point on the celestial sphere where) the sun appears to 'stand still' at greatest declination north. Do not fail to notice the points of the compass. Also verify at midsummer the indicated direction (southeast-by-east) in which the tree's shadow falls at sunset; and near the beginning of the summer vacation it will be worth while to arise once at five o'clock in the morning, in order to verify also the southwest-by-west direction of the

shadow just after sunrise. By the latter part of June, the noontime shadow again begins to lengthen; more and more rapidly with each day it lengthens until the equinox of autumn, when the cycle of one year of observation is complete.

To observe the Inclination of Equator to Ecliptic.—As equator and ecliptic are both great circles, the sun goes as far north in summer as it goes south in winter. Half the extreme range is the angle of inclination of ecliptic to equator, and it is technically termed the obliquity of the ecliptic. Its value for 1900 is $23^{\circ} 27' 8''.02$, and it changes very slowly. A rough value is readily found for any year by making use of the latitude-box already described on page 71. At noon on the 20th, 21st, and 22d of December, observe the readings on the arc where the sun's line falls. Be sure that the box remains undisturbed, or test the vertical arm of the quadrant by the plumb-line each day. Leave the box in position through the winter and spring, or set up the same box again in June, and again apply the plumb-line test. At noon on the 20th, 21st, and 22d of June, observe the sun's reading as at the other solstice. Take the difference of readings as follows:—

Reading of 22d December from 20th June;
21st December from 21st June;
20th December from 22d June.

Then halve each of the three differences, and the results will be three values for the inclination of equator to ecliptic. Take the average of them for your final value. Thus in about six months' time you will have all the observations needed for a new value of the obliquity of the ecliptic. True, its accuracy may not be such that the government astronomers will ask to use it in place of the refined determinations of Le Verrier and Hansen, but your practical knowledge of an elementary principle by which the obliquity is found will be worth the having.

Following are readings made in this manner at Amherst, Massachusetts:—

ARC-READING	ARC-READING	OBLIQUITY
June 20, $71^{\circ}.2$	Subtract December 22, $24^{\circ}.3 = 46^{\circ}.9$	$23^{\circ}.45$
21, $71^{\circ}.0$	21, $24^{\circ}.0 = 47^{\circ}.0$	$23^{\circ}.5$
22, $70^{\circ}.9$	20, $24^{\circ}.1 = 46^{\circ}.8$	$23^{\circ}.4$
	Mean value of obliquity = $23^{\circ} 27'$	

Explanation of the Equation of Time.—The reason may now be apprehended why mean sun and real sun seldom cross the meridian together. It is chiefly due to two independent causes, (1) The orbit in which our earth travels round the sun is an ellipse. Motion in it is variable—swiftest about the 1st of January, and slowest about the 1st of July. On these dates, the equation of time due to this cause vanishes. Nearly intermediate it has

a mean rate of motion; therefore at these times (about 1st April and 1st October), the true sun and the fictitious sun must both travel at the same rate in the heavens.

But the real sun has been running ahead all the time since the beginning of the year, as this figure shows; so that on the 1st of April, the equation of time, from this cause alone, is eight minutes. The sun is slow by this amount because it has been traveling eastward so rapidly. On 1st October it is fast a like

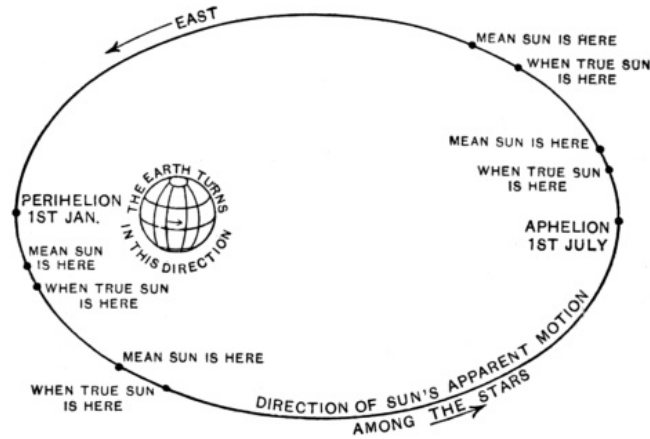

Relation of True Sun to Mean Sun

amount, because it has been moving very slowly through aphelion in the summer months; therefore the real sun comes to the meridian earlier than it should, and it is said to be fast.

(2) The second cause is the obliquity of the ecliptic. Suppose that the sun's apparent motion in the ecliptic were uniform: near the solstices its right ascension would increase most rapidly, because the hour circles converge toward the celestial poles just as meridians do on the earth. The case is like that of a ship sailing due east or west at a uniform speed: when in high latitudes she 'makes longitude' much faster than she does near the equator. As due to the second cause the equation of time vanishes four times a year; twice at the equinoxes and twice at the solstices. At intermediate points (about the 8th of February, May, August, and November), the sun is alternately slow and fast about 10 minutes. Combining both causes gives the equation of time as already presented in the table on page 98. It is zero on 16th April, 15th June, 1st September, and 25th December. The sun is slowest ($14\frac{1}{2}$ minutes) about 11th February, and fastest ($16\frac{1}{3}$ minutes) about 3d November. Attention is next in order turned to that remarkable yearly variation in conditions of heat and cold in our latitudes, called the seasons.

The Seasons in General.—Those great changes in outward nature which we call the seasons are by no means equally pronounced everywhere throughout our extended country. It is well, therefore, to sketch them in outline, from a naturalist's point of view, which is quite different from that of the astronomer.

The earliest peoples noted these variations for practical purposes, chiefly seedtime



Earth's Axis inclined $66\frac{1}{2}^\circ$ to the Plane of its Orbit

and harvest. But as men grew past the necessities of mere living, they began to observe the natural beauty of each season as it came. Not knowing what occasioned the unvarying succession of these fixed, yet widely different conditions of the year, all sorts of fanciful explanations were invented. Clearly it is not the simple nearness or distance of the sun, as we approach or recede in our orbit, which causes our changing seasons, for in our winter we are, as has already been said, 3,000,000 miles nearer than in summer. But as earth passes round the sun in its yearly path, the axis remains always from year to year practically parallel to itself in space (neglecting the effect of precession), its inclination to the ecliptic being $66\frac{1}{2}^\circ$ as shown in the outline figure above. Alternately, then, the poles of earth are tilted toward and from that all-potent and heat-giving luminary. So in the sunward hemisphere summer prevails because of accumulated heat: more is received each day than is lost by radiation each night. But in the hemisphere turned away from the sun for the time, gradually temperature is lowered by withdrawal of life-giving warmth, more and more each day. Medium temperatures of autumn follow, and eventually it becomes midwinter.

Spring and Summer.—But when, by the earth's journeying onward in its orbital round, the pole again becomes tilted more and more toward the sun, soon an awakening begins. The melting of ice and snow, the gradual reviving of brown sods, the flowing of sap through branches apparently lifeless, the mist of foliage beginning to enshroud every twig until the whole country is enveloped in a soft haze of palest green and red, gray and yellow,—all these are Nature's signs of spring. Biologists tell us that this vegetal awakening comes when the temperature reaches 44° Fahrenheit. Soon come the higher temperatures requisite for more mature development, and midsummer follows rapidly. The astronomer can, of course, say just when in June our longest day comes—when the sun rises farthest north and sets farthest north, thereby shining more nearly vertically upon us at noon, and remaining above the horizon as long as possible; when daylight lasts with us until long past eight o'clock, and in England and Scotland until nearly ten. But who can divine just when the country stands at the fullest flood tide of summer, with the rich growth of vegetation, tangled masses of flowers and foliage, roadsides crowded with beauty, the shimmer of heat above ripening fields, perfecting grains, and early fruits? Or when it first begins to ebb? That

is for another observer no less subtle than the astronomer with his measuring instruments and geometric demonstrations. Very different, too, is the time in different places; often there is a wide range of local conditions which modify greatly the effects produced by purely astronomical causes.

Autumn and Winter.—Thoreau, that keen observer of times and seasons, used always to detect signs of summer's waning in early July. But persons in general notice few of the advance signals of a dying year. Not until falling leaves begin to flutter about their feet, and grapes and apples ripen in orchard and vineyard, do they realize that autumn is really here—that season of fulfillment, when everything is mellow and finished. Our hemisphere of the earth is turning yet farther away from that sun upon which all growth and development depend. When trees are a glory of red and yellow and russet brown, when corn stands in full shocks in fields, and day after day of warmth and sunshine follow through royal October,—it seems impossible to believe that slowly and surely, winter can be approaching. But soon chilly winds whistle through trees from which the bright leaves are almost gone; a thin skim of ice crystals shoots across wayside pools at evening, and speedily shivering winter is upon us. Just before Christmas, this part of our earth is tipped its farthest away from the sun. Then, for a few days, the hours of darkness are at their longest. The sap has withdrawn far into the roots of trees until the cold shall abate; leaden skies drop snowflakes, and earth sleeps under a mantle of white. Cold is apt to increase for a month after the sun has actually begun to journey northward. His rays, warm and brilliant, flood every nook and crevice in leafless forests; but where is their mysterious power to call life into bare branches, to wake the flowers, and stir the grass? It is almost startling to think that a permanent withdrawal of even a slight amount of the sun's warmth would freeze this fair earth into perpetual winter—that a small change in the tilt of our axis might make arctic regions where now the beauty of summer reigns in its turn. But the laws of the universe insure its stability; and changes of movement or direction are very slow and gradual, so that all our familiar variation of seasons, each with its own charm, cannot fail to continue for more years than it is possible to apprehend. In late January, weeks after our hemisphere has begun again to turn sunward, even the most careless observer notes the lengthening hours of daylight, and knows that spring is coming. That thrill of mysterious life which this earth feels at greater warmth, and the quiet acceptance of its withdrawal, have been celebrated by poets in all ages; and the astronomer's explanations of whys and wherefores cannot add to these marvelous changes anything of beauty or perennial interest, although they may conduce to completeness and precision of statement.

Explanation of the Change of Seasons.—So much for mere description: the explanation has already been hinted. Our change of season is due to obliquity of the ecliptic, or to the fact that the axis of our planet, as it

travels round the sun, keeps parallel to itself, and constantly inclined to its orbit-plane by an angle of $66\frac{1}{2}^{\circ}$. The opposite illustration should help to make this clear.

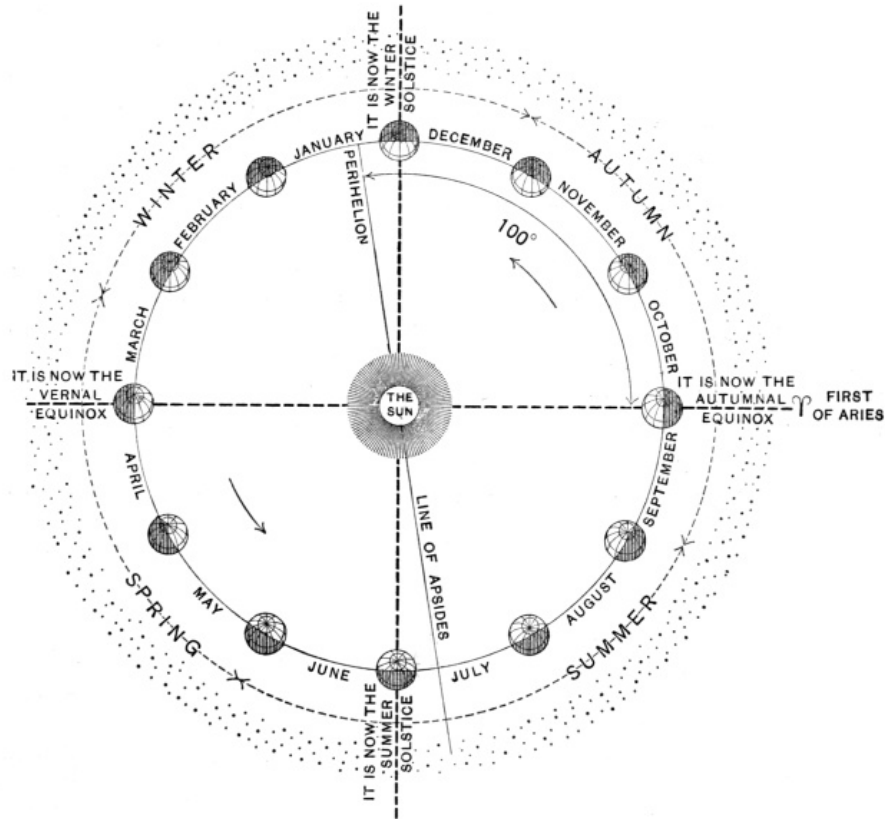

View of Earth's Orbit from the North Pole of the Ecliptic

Beginning at the bottom of the figure, or at midsummer, it is apparent how the earth's northern pole is tilted toward the sun by the full amount of the obliquity, or $23\frac{1}{2}^{\circ}$. It is midsummer in the northern hemisphere, also it is winter in the southern, because the south pole is obviously turned away from the sun. Passing round to autumn, in the direction of the large arrows, reason for the equable temperatures of that season is at once apparent: it is the time of the autumnal equinox, or of equal day and night everywhere on the earth, and the sun's rays just reach both poles. Going still farther round in the same direction, to the top of the illustration, the winter solstice is reached; it is northern winter because the north pole is turned away from the sun and can receive neither light nor heat therefrom; also the southern hemisphere is then enjoying summer, because the south pole is turned $23\frac{1}{2}^{\circ}$ toward the sun. Again moving quarter way

round, to the left side of the illustration, the season of spring is accounted for, and the temperature is equable because it is now the vernal equinox. Another quarter year, or three months, finds the earth returned to the summer solstice; and so the round of seasons runs in never-ending cycle.

Earth receives most Heat at Midday.—It is necessary to examine into the detail of these changes of light and heat a little more fully. Every one is aware how much warmer it usually is at noon than at sunrise or sunset, mostly because of change in inclination of the sun's rays from one time of day to another. Any surface becomes the warmer, the more nearly perpendicularly the sun's rays strike it, simply because more rays fall upon it.

In the figure, *ab*, *cd*, and *ef* are equal spaces, and *R* is the bundle of solar rays falling upon them. Obviously more rays fall upon *cd* than upon *ab*, because the rays are parallel. But the lessened warmth of sunrise and sunset is partly due to greater absorption of solar heat by our atmosphere at times when the sun is rising and setting, because its rays must then penetrate a much greater thickness of the air than at noon. Suppose the observer to be located within the tropics, because there the sun's rays may be perpendicular to the earth's surface, as shown in the diagram below, while in our latitudes they never can be quite vertical

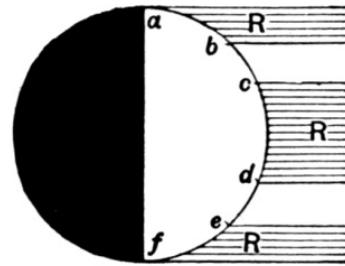

A Surface receives most Rays when they fall Perpendicularly upon it

even at midsummer noon. There the sun's rays may travel vertically downward at apparent noon; and it is evident from the illustration that a beam of sunlight of a given width *KL* traverses only that relatively small part of the earth's atmosphere included between *KL*, *MN*. Now at sunrise observe the different conditions under which a beam of sunlight of the same breadth as *KL* is obliged to traverse the atmosphere. Observe, too, how much more atmosphere *ABCD* this beam must pass through. As the sun's energy is absorbed in heating this greater volume of air, evidently the amount of heat arriving at the earth's surface, *CD*, where we are directly conscious of it, must be less by the amount which the atmosphere has absorbed. Besides this the amount of solar heat which falls upon a given area between *C* and *D* will evidently be less than that received by an equal area between *M* and *N*, in proportion as *CD* is greater than *MN*. Like conditions prevail at sunset as shown.

Our Latitudes receive most Heat at the Summer Solstice.—In an earlier chapter it was explained how the sun, by its motion north, crosses

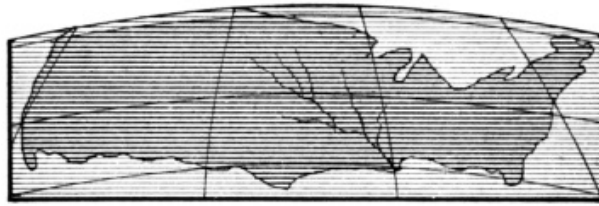

The United States as seen from the Sun in Midwinter

higher and higher on our meridian every day, from the winter solstice to the summer solstice. Just as each day the heat received increases from sunrise to noon, and then decreases to sunset, so the heat re-

ceived at noon in a given place of middle north latitude, increases from the winter solstice to a maximum at the summer solstice. Also the sun's diurnal arc has all this time been increasing, so that a given hour of the morning, as nine o'clock, and a given hour of the afternoon, as three o'clock, places the sun higher and higher. The heat received, then, increases for two independent though connected reasons: (1) the sun culminates higher each day, and (2) it is above the horizon longer each day. The illustration (page 28) makes both reasons clear. The greater length of daytime exerts a powerful influence in modifying the summer temperatures of regions in very high latitudes where the summer sun shines continually through the 24 hours. For example, at the summer solstice, the sun pours down, during the 24 hours, one fifth more heat upon the north pole than upon the equator, where it shines but 12 hours. So it is not easy to calculate the relative heat received at different latitudes, even if we neglect absorption by the atmosphere. With this effect included, the problem becomes more complicated still. If earth and atmosphere could retain all the heat the sun pours down upon them, the summer solstice would mark also the time of greatest heat. But in our latitudes radiation of heat into space retards the time of greatest accumulated heat more than a month after the summer solstice. For evidently the atmosphere and the earth are storing heat so

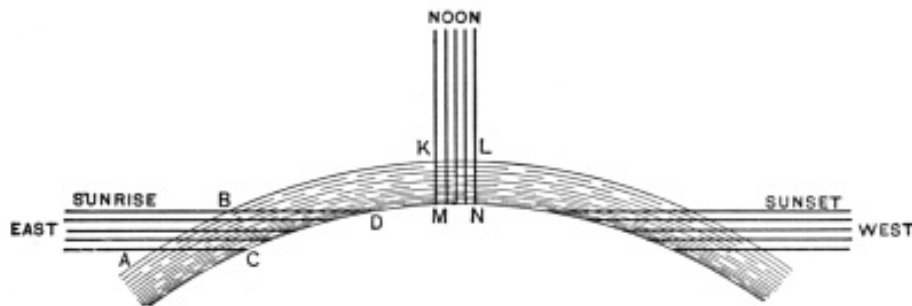

The Solar Beams are spread out and absorbed at Sunrise and Sunset

long as the daily quantity received exceeds the loss by radiation. For a similar reason, the time of greatest cold, or withdrawal of warmth, is not coincident with the winter solstice, but lags till the latter part of January.

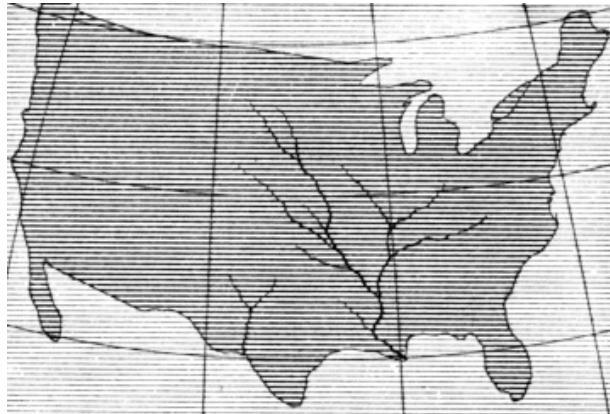

The United States as seen from the Sun in Midsummer

Accumulation ceases when Loss equals Gain.—Illustration by a three weeks' petty cash account should make this apparent. You start with 50 cents cash in hand. For the first week, you receive 25 cents Monday, and spend 15; 30 cents Tuesday, and spend 18; and so on, receiving five cents more each day, and spending three cents more than the day before. At the end of the week you will have \$1.40. The second week, your receipts and expenditures are equal in amount to the first, but reversed as to days—your allowance is 50 cents Monday, and you spend 30; 45 cents Tuesday, and you spend 27; and so on. On the second Saturday your expense account will be the same as for the first Monday—you receive 25 cents and spend 15; but your accumulated wealth will then be \$2.30. The third week you receive 25 cents Monday, 20 cents Tuesday, and so on, but through the week you spend 15 cents each day. For two weeks your

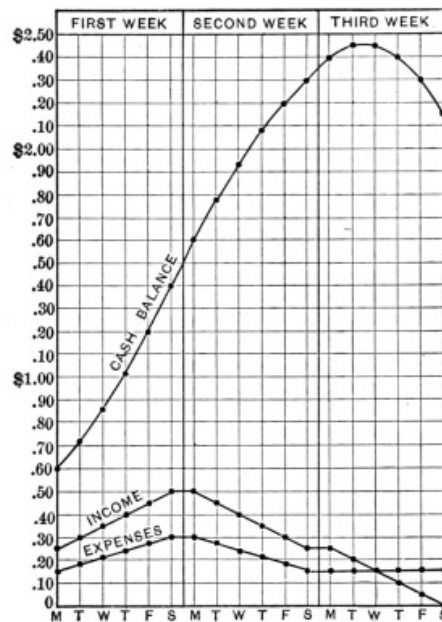

Cash increases till Expenses and Income are Equal

income has steadily been falling off, from 50 cents daily to nothing; but your total cash in hand kept on accumulating, and did not begin to decrease until the middle of the third week, and on the third Saturday you close the account with \$2.15 in hand. Cash in hand at the beginning is the temperature about the middle of May, and the end of the first week corresponds to the summer solstice. Income is the amount of heat received from the sun, and expenditure is the amount radiated into space. Just as cash in hand went on accumulating long after receipts began to fall off, so the average daily temperature keeps on rising for more than a month after the solstice, when the amount received each day is greatest. The diagram shows the entire account at a glance, and illustrates at the same time a method of investigation much employed in astronomical and other researches, called the graphical method. Its advantages in presenting the range of fluctuations clearly to the eye are obvious.

The Seasons Geographically.—The astronomical division of the seasons has already been given in the figure on page 134. It is as follows:—

Spring, from the vernal equinox, three months.
 Summer, from the summer solstice, three months.
 Autumn, from the autumnal equinox, three months.
 Winter, from the winter solstice, three months.

But according to the division among the months of the year, as commonly recognized in this part of the world, each season precedes the astronomical division by nearly a month, and is as follows:—

Spring = March, April, May.
 Summer = June, July, August.
 Autumn = September, October, November.
 Winter = December, January, February.

Differences of climate and in the forward or backward state of vegetable life, in part dependent upon local conditions, have led to different divisions of the calendar months among the seasons, varying quite independently of the latitude. Great Britain's spring begins in February, its summer in May, and so on. Toward the equator the difference of season is less pronounced, because the annual variation of the sun's meridian altitude is less; and as changes in rainfall are more marked than those of temperature, the seasons are known as dry and rainy, rather than hot and cold. These marked differences of season are recognized by the division of the earth's surface into five zones.

Terrestrial Zones.—From the relation of equator to ecliptic, and from the sun's annual motion, it is plain that twice every year the sun must shine vertically over every place whose latitude is less than $23\frac{1}{2}^{\circ}$, whether

north or south. This geometric relation gives rise to the parallels of latitude called the *tropics*; the Tropic of Cancer being at $23\frac{1}{2}^{\circ}$ north of the equator, and the Tropic of Capricorn at $23\frac{1}{2}^{\circ}$ south. They receive their names from the zodiacal signs in which the sun appears at these seasons. The belt of the earth included between these small circles of the terrestrial sphere is called the *torrid zone*. Its width is 47° , or nearly 3300 miles. Similarly there are zones around the earth's poles where, for many days during every year, the sun will neither rise nor set. These polar zones or caps are also 47° in diameter. Between them and the torrid zone lie the two temperate zones, one in the northern and one in the southern hemisphere, each 43° , or about 3000 miles in width. The sun can never cross the zenith of any place within the temperate zones. If equator and ecliptic were coincident, that is, if the axis of the earth were perpendicular to the plane of its path round the sun, day and night would never vary in length, and our present division into zones would vanish.

The Seasons of the Southern Hemisphere.—Our earth in traveling round the sun preserves its axis not only at a constant angle to the plane of its orbit, but always for a limited period of years pointing to nearly the same part of the heavens, as shown in the figure on page 58. Plainly, then, the seasons of the southern hemisphere must occur in just the order that our northern seasons do. In its turn the south pole inclines just as far toward the sun as the north one does. But in so far as astronomical conditions are concerned, the southern seasons will be displaced just six months of the calendar year from ours. The following figures of the earth at solstices and equinoxes make these relations clear. Midwinter in the southern hemisphere

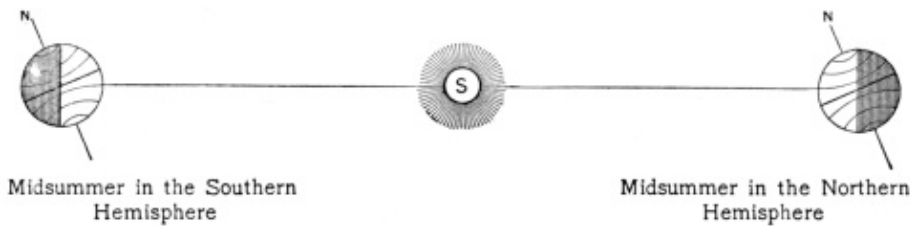

comes in June and July, and Christmas falls in midsummer. The opening of their spring comes in August and September, and autumn approaches in February and March. But while in the northern hemisphere the difference between the heat of midsummer and the cold of midwinter is somewhat lessened by the changing distance of the sun, in the southern hemisphere this effect is intensified, because the earth comes to perihelion in the southern midsummer. However, on account of the swifter motion of the earth from October to March than from April to September, the southern summer

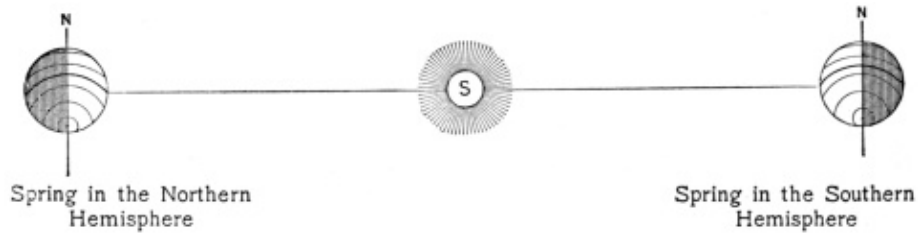

is enough shorter to compensate for the sun's being nearer, so that the southern summer is practically no hotter than the northern. On the other hand, the southern winter not only lasts about seven days longer than the northern, but it is colder also, because the sun is then farthest away. The range of difference in the heat received at perihelion and aphelion is about $\frac{1}{15}$ part of the total amount.



Aberration of the Raindrop is Greater as the Body moves Swifter

Annual Aberration.—In looking from a window into a quiet, rainy day, the drops are seen to fall straight down earthward from the sky. But if, instead of watching from shelter, you go out in the rain and run swiftly through it, the effect is as if the drops were to slant in oblique lines against the face. For the man under the umbrella, the leisurely boy with rubber

coat and hat on, and the courier caught in the rain, how different the direction from which the drops seem to come. A similar but even more exaggerated effect may be watched in a railway train speeding through a quiet snowstorm; it seems as if the flakes sped past in an opposite direction, in white streaks almost horizontal,—the result of swift motion of the train, combined with that of the slowly falling snow. This appearance is called *aberration*, and in reality the same effect is produced by the progressive motion of light. Now replace the moving train by the earth traveling in its orbit round the sun, and let the falling raindrop or snowflake represent the progressive motion of light; then as the angle between the plumb-line and the direction from which rain or snow seems to come is the aberration of the descending drop or flake, so the angle between the true position of the sun and the point which its light seems to radiate from is the annual aberration of light. It is usually called aberration simply, and was discovered by Bradley in 1727.

The Constant of Aberration.—Notice two things: (*a*) that raindrop and snowflake both appear to come from points in advance of their true direction; (*b*) that this angle of aberration is less as the velocity of the falling drop or flake is greater. The snowflake falls very slowly in comparison with the speed of the train, so the angle of aberration was observed to be perhaps 80° or more; but where the velocity of the raindrop was nearly the same as the speed of the train, the angle of aberration was only 45° . Now imagine the velocity of the drop increased enormously, until it is 10,000 times greater than the speed of the train: then we have almost exactly the relation which holds in the case of the moving earth and the velocity of a wave of light. In a second of time the earth travels $18\frac{1}{2}$ miles, and light 186,300 miles. But we found that any object which fills an angle of $1''$ is at a distance equal to 206,000 times its own breadth; so that the angle of annual aberration of the sun must be the same as that filled by an object at a distance of only 10,000 times its own breadth. This angle is $20''.5$, and it is called the constant of aberration. It corresponds to the mean motion of the earth in its orbit. At aphelion, where this motion is slowest, the sun's aberration drops to $20\frac{1}{6}''$; at perihelion, where fastest, it rises to $20\frac{5}{6}''$. The constant of aberration has been determined with great accuracy from observations of the stars; and its exact correspondence with the motion of the earth may be regarded as indisputable proof of our motion round the sun.

Aberration of the Stars.—Aberration is by no means confined to the sun; but it affects the apparent position of the fixed stars as well. Observation shows that every star seems to describe every year in the sky a small ellipse. These aberration ellipses traversed by the stars all have equal

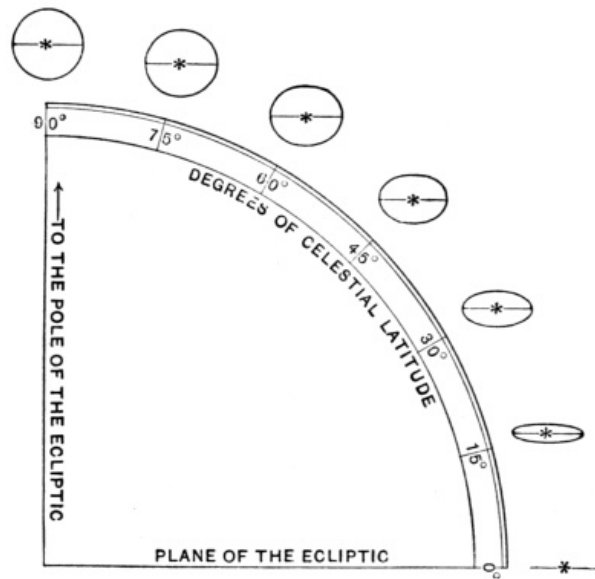

Aberration Ellipses of the Stars

would reach across the disk of the moon. For a star at the pole of the ecliptic, the minor axis is equal to the major axis; that is, the star's aberration ellipse is a circle 41'' in diameter. As shown in the illustration, the ellipses grow more and more flattened, for stars nearer and nearer the ecliptic; and when the star's latitude is zero, the aberration ellipse becomes seemingly a straight line, but actually a small arc of the ecliptic itself, 41'' in length. In calculating all accurate observations of the stars, a correction must be applied for the difference between the center of the ellipse (the star's average place), and its position in the ellipse on the day of the year when the observation was made. Every star partakes of this motion, and thus proof of earth's motion round the sun becomes many million fold.

The Year.—Just as there are two different kinds of day, so also there are two different kinds of year. Both are dependent upon the motion of the earth round the sun, but the points of departure and return are not the same. Starting from a given star and returning to the same star again, the earth has consumed a period of time equal to 365d. 6 h. 9 m. 9 sec. This is the length of the sidereal year. But suppose the earth to start upon its easterly tour from the vernal equinox, or first of Aries: while the year is elapsing, this point travels westward by precession of the equinoxes, so that the earth meets it in 20 m. 23 sec. less than the time required for a complete sidereal revolution. This, then, is the tropical year, and its length is equal to 365 d. 5 h. 48 m. 46 sec. It is the ordinary year, and forms the basis of the

major axes; that is, an arc of 41'', or double the constant of aberration. But their minor axes vary with the latitude, or distance of the star from the ecliptic. Try to conceive these ellipses in the sky; the major axis of each one coincides with the parallel of latitude through the star, and their size is such that they are just beyond the power of human vision. About 50 aberration ellipses placed end to end with their major axes in line

calendar. Another kind of year, strictly of no use for calendar purposes, is called the anomalistic year, and is the time consumed by the earth in traveling from perihelion round to perihelion again. We saw that the line of apsides moves slowly forward, at such a rate that it requires 108,000 years to complete an entire circuit of the ecliptic. The anomalistic year, therefore, is over $4\frac{1}{2}$ minutes longer than the sidereal year, its true length being 365 d. 6 h. 13 m. 48 s.

The Calendar.—Two calendars are in use at the present day by the nations of the world: the Julian calendar and the Gregorian calendar.

The former is named after Julius Cæsar, who, in B.C. 46, reformed the calendar in accordance with calculations of the astronomer Sosigenes. The true length of the year was known by him to be very nearly $365\frac{1}{4}$ days; so Cæsar decreed that three successive years of 365 days should be followed by a year of 366 days perpetually. But as the Julian year is 11.2 minutes too long, the error amounts to about three days every 400 years. In the latter part of the 16th century, the accumulation of error amounted to 10 days. Pope Gregory XIII corrected this, and established a farther reform, whereby three leap-year days are omitted in four centuries. Years completing the century, as 1900 and 2000, are *centurial* years. Every year not centurial whose number is exactly divisible by 4 is a leap year; but centurial years are leap years only when exactly divisible by 400. The year 1900, then, is not a leap year, but the year 2000 is. In 1752 England adopted the Gregorian calendar, and earlier dates are usually marked O. S. (old style). At the same time, England transferred the beginning of the year from 25th March to 1st January, the date adopted by Scotland in 1600, and by France in 1563. Thus before 1752, dates between 1st January and 24th March fell in different years in England and in Scotland or France, and frequently both years are written in early English dates—as 23d January, $17\frac{26}{27}$, the lower figure indicating the year according to Scotch and French, and the upper to early English, reckoning. Russia and Greece still employ the Julian calendar. Dates in these countries are usually written in fractional form; for example, July $\frac{10}{23}$, the numerator referring to the Julian calendar, and the denominator to the Gregorian. The year 1900 is, therefore, a leap year in Russia and Greece, and their difference of reckoning from ours is 13 days through the 20th century.

The Week.—It embraces seven days, and has been recognized from the remotest antiquity. Its days are:—

THE DAYS OF THE WEEK

ENGLISH	SYMBOL	DERIVATION	FRENCH	GERMAN
Sunday	☉	Sun's day	Dimanche	Sonntag
Monday	☾	Moon's day	Lundi	Montag
Tuesday	♃	Tuisco's day	Mardi	Dienstag
Wednesday	♃	Woden's day	Mercredi	Mittwoch
Thursday	♃	Thor's day	Jeudi	Donnerstag
Friday	♀	Freya's day	Vendredi	Freitag
Saturday	♄	Saturn's day	Samedi	Sonnabend

Tuisco is Saxon for the deity corresponding to the Roman Mars, Woden for Mercury, Thor for Jupiter, and Freya for Venus; therefore the symbols of the corresponding planets were adopted as designating the appropriate days of the week. These symbols are more often used in foreign countries than in our own. The relation of the week to the year is so close ($52 \times 7 = 364$) as to suggest a possible improvement in the calendar.

Memorizing the Days in the Month.—To many persons the varying number of days in the months of our year is a great inconvenience. This time-worn stanza is sometimes helpful:—

Thirty days hath September,
 April, June, and November;
 All the rest have thirty-one,
 Save February, which alone
 Hath twenty-eight, and one day more
 We add to it one year in four.

The facts are there, even if the rhythm cannot be defended. An easier method of memorizing the succession is apparent from the illustration below: Close the

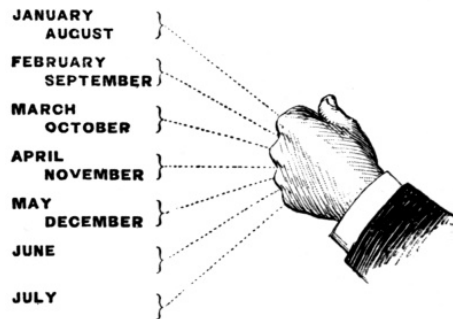

To recall the Number of Days in Each Month

hand and count out the months on the knuckles and the depressions between them, until July is reached, then begin over again. The knuckles represent long months, and the depressions short ones.

Reforming the Calendar.—

The inconveniences of our present Gregorian calendar are many. Some authorities think it on the whole no improvement on the Julian calendar; and certainly much confusion would have been avoided, if the Julian calendar

had been continued in use everywhere. A return to the Julian reckoning at the beginning of the 20th century, 1st January, 1901, was once suggested by Newcomb, the eminent American astronomer; but any such change can be brought about only by wide international agreement. An obvious change having many advantages would be the division of the year into 13 months, each month having invariably 28 days, or exactly four weeks. Legal holidays and anniversaries would then recur on the same days of the week perpetually. The chief difficulty would arise in the proper disposition of the extra day at the end of each ordinary year; and of two extra days at the end of each leap year.

Easter Sunday.—Easter Day is a movable festival, because it falls on different dates in different years. It is kept on the Sunday next after the fourteenth day of the Paschal moon; the Paschal moon being that moon of which the fourteenth day (approximately the full moon) occurs on or next after the 21st of March. Hence Easter cannot occur earlier than March 22 (when the fourteenth day of the Paschal moon is Saturday, March 21), nor later than April 25 (when the fourteenth day of the Paschal moon is Sunday, April 18).

Easter is not, however, determined by the true sun and moon, but by the motion of the fictitious sun and of a fictitious moon imagined to travel round the celestial equator uniformly with the time. Consequently the above rule must sometimes fail if applied to the phases of the moon as given in the almanac. Many have been the bitter controversies about the proper day to be observed as Easter, through differing methods of calculation as well as through differing rules. Following are the dates of Easter for about a third of a century:—

YEAR	DATE	YEAR	DATE	YEAR	DATE	YEAR	DATE
1890	April 6	1899	April 2	1908	April 19	1917	April 8
1891	March 29	1900	April 15	1909	April 11	1918	March 31
1892	April 17	1901	April 7	1910	March 27	1919	April 20
1893	April 2	1902	March 30	1911	April 16	1920	April 4
1894	March 25	1903	April 12	1912	April 7	1921	March 27
1895	April 14	1904	April 3	1913	March 23	1922	April 16
1896	April 5	1905	April 23	1914	April 12	1923	April 1
1897	April 18	1906	April 15	1915	April 4	1924	April 20
1898	April 10	1907	March 31	1916	April 23	1925	April 12

Having now learned the A B C's of the language which astronomers use, and having studied the earth as a revolving globe and the seeming motions of the stars relatively to it; also having ascertained many facts connected with our yearly journey round the sun,—we may next seek to apply that knowledge in a long voyage, begun early in December, from New York to Yokohama by way of Cape Horn.

Chapter VIII

The Astronomy of Navigation

On an actual voyage to Japan and back, we shall investigate new astronomical questions in the order of their coming to our notice, and verify many astronomical relations founded on geometric truth. So we shall be learning a cosmopolitan astronomy of use in foreign countries as well as at home, and acquiring some knowledge of astronomical methods by which ships are safely guided across the oceans.

Navigation.—Navigation is the art of conducting a ship safely from one port to another. When a ship has gone 20 miles out to sea, all landmarks will usually have disappeared, and the sea horizon will extend all the way round the sky. Look in whatsoever direction we will, nothing can be seen but an expanse of water (page 24), apparently boundless in extent. Outside the ship there is nothing whatever to tell us where we are, or in what direction to steer our craft. Every direction looks like every other direction. Still the accurate position of the ship must be found. The only resource, then, is to observe the heavenly bodies, and their relation to the horizon.

The navigator must previously have provided himself with the lesser instruments necessary for such observation; and the technical books and mathematical tables by means of which his observations are to be calculated. These processes of navigation are astronomical in character, and the principles involved are employed on board every ship. The computations required in ordinary navigation are based upon the data of an astronomical book called the *Nautical Almanac*.

The Nautical Almanac.—The Nautical Almanac contains the accurate positions of the heavenly bodies. They are calculated three or four years in advance, and published by the leading nations of the globe. Foremost are the British, American, German, and French Nautical Almanacs. Table 8.1 is a part of a page of *The American Ephemeris and Nautical Almanac for 1899*, showing data relating to the sun.

The intervals here are one day apart; but for the moon, which moves among the stars much more rapidly, the position is given for every hour. Also the angular

distance of the moon from certain stars and planets is given at intervals of three hours. Upon the precision of the Nautical Almanac depends the safety of all the ships on the oceans. Besides the figures required in navigating ships, the Nautical Almanacs contain a great variety of other data concerning the heavenly bodies, used by surveyors in the field and by astronomers in observatories.

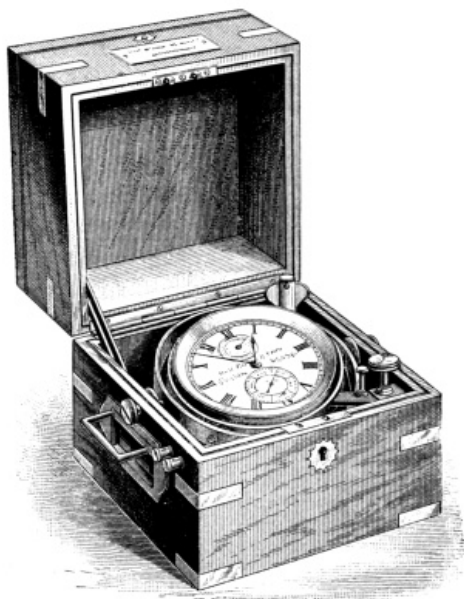

The Chronometer

The Ship's Chronometers.—

Some hours before the departure of the vessel, two boxes about a foot square are brought on board with the greatest care, and secured in the safest part of the ship, where the temperature will be nearly constant. Within each box is another, about eight inches square, shown open in the picture opposite. Inside it is a large watch, very accurately made and adjusted, forming one of the most important instruments used in conducting ships from port to port. It is called the marine chronometer, or box chronometer, but generally the chronometer simply. The face, about $4\frac{1}{2}$ inches in diameter, is usually dialed to 12 hours, as in ordinary watches. In addition to the second hand at the bottom of the face, there is a separate index at the top to indi-

cate how many hours the chronometer has been running since last wound up; for, like all good watches, winding at the same hour every day is essential. Spring and gears are so related that a chronometer ordinarily runs 56 hours, though it should be wound with great care at regular intervals of 24 hours—the extra 32 being a concession to possible lapses of memory. Other chronometers, wound regularly every week, are constructed to run an extra day, and so are called ‘eight-day’ chronometers. All these instruments are so jeweled that they will run perfectly only when the face is kept horizontal; they are therefore hung in gimbals, a device with an intermediate ring, and two sets of bearings with axes perpendicular to each other. As the chronometer case is hung far above its center of gravity, its face always remains horizontal, no matter what may be the tilt of the outer box, in consequence of the rolling or pitching of the ship. The instrument shown in the illustration is of that particular type known as a *break-circuit* chronometer, so called because an electric circuit (through wires attached to the two binding posts on the left side of the box) is automatically broken at the beginning of every second, by means of a very delicate spring attached alongside one of the arbors. Such a chronometer is generally employed by surveying expeditions in the field,

Table 8.1: OCTOBER, 1899

		AT GREENWICH APPARENT NOON							
Day of the Week	Day of the Month	THE SUN'S					Sideral Time of Semidiameter Passing Meridian	Equation of Time, to be Subtracted from Apparent Time	Diff. for 1 Hour
		Apparent Right Ascension	Diff. for 1 Hour	Apparent Declination	Diff. for 1 Hour	Semidiameter			
		h. m. s.	s.	° ' "	"	' "	s.	m. s.	s.
SUN.	1	12 29 39.39	9.058	S. 3 12 15.5	-58.27	16 1.37	64.37	10 19.23	0.796
Mon.	2	12 33 16.94	9.071	3 35 33.0	58.18	16 1.64	64.41	10 38.18	0.783
Tues.	3	12 36 54.82	9.085	3 58 48.0	58.07	16 1.91	64.46	10 56.81	0.769
Wed.	4	12 40 33.03	9.099	4 22 00.3	-57.95	16 2.19	64.51	11 15.10	0.755
Thur.	5	12 44 11.59	9.114	4 45 09.4	57.81	16 2.47	64.56	11 33.04	0.740
Frid.	6	12 47 50.52	9.130	5 8 14.9	57.65	16 2.75	64.62	11 50.61	0.724
Sat.	7	12 51 28.94	9.147	5 31 16.5	-57.48	16 3.03	64.68	12 07.80	0.708
SUN.	8	12 55 9.56	9.164	5 54 13.8	57.29	16 3.31	64.74	12 24.59	0.691
Mon.	9	12 58 49.70	9.182	6 17 6.4	57.09	16 3.60	64.80	12 40.96	0.673

where a chronograph (page 188) is needed to record the star observations, and where a clock would be too bulky and inconvenient.

What the Chronometers are for.—The real purpose of chronometers is to carry Greenwich time, and the need of this is made clear farther on. For at least a fortnight before they are brought on board ship, all chronometers are carefully tested and compared with a standard clock, regulated by frequent observations of the sun and stars, usually at some astronomical observatory. So at the outset of our voyage we see how intimate is the relation between practical astronomy and the useful art of navigation. The navigator of the ship is provided with a memorandum for each chronometer, showing how much it is fast or slow on Greenwich time, and how much it is gaining or losing daily. The amount by which it is fast or slow is called the chronometer error or correction; and the rate is the amount it gains or loses in 24 hours. If the chronometer is a good one and well adjusted, the rate should be only a small fraction of a second. As a rule, on voyages of moderate length, the Greenwich time can always be found from the chronometers within three or four seconds of the truth. This uncertainty amounts to about a mile in the position of the ship. To avoid the possibility of entire loss of the Greenwich time by any accident to a single chronometer, ships nearly always carry two, and often many more.



Works of the Chronometer (Size compared with Ordinary Watch)

The Works of the Chronometer.—Familiarity with the interior of any watch will help in understanding the finer and more complicated works of the chronometer, well shown in the illustration. The ordinary watch alongside indicates the relative size of the parts. The chronometer balance is about one inch in diameter, and the hairspring about $\frac{1}{3}$ inch in diameter, and $\frac{1}{4}$ inch high. Fusee, winding post, and some other details are well seen. On the left is the glass crystal, set in a brass cell which screws on top of the brass case, shown on the right. On the right-hand side of this case is seen one of the pivot bearings by which it swings in the gimbals.

The Chronometer Balance.—

A balance compensated for temperature is necessary to the satisfactory running of a chronometer, because a chronometer with a plain, uncompensated brass balance will lose $6\frac{1}{9}$ seconds daily for each Fahrenheit degree of rise in temperature. In order to counteract this effect, marine chronometers (and all good watches) are provided with a balance, the principle of which is shown in the illustration. The arm passing centrally through the balance is of steel, and at its ends are two large-headed screws, for making the chronometer run correctly at a standard temperature, say 62° . The semicircular halves of the rim are cut free, being attached to the arm at one end only. The rim itself is composed of strips of brass and steel firmly brazed together. The outer part is brass, and the inner steel, of one half the thickness of the brass. With a rise of temperature, brass tends to expand more rapidly than steel; and by overpowering the steel, it bends the free ends of the rim inward, practically making the balance a little smaller. When the temperature falls, the balance enlarges again slightly. Near the middle of each half rim is a weight, which can be moved along the rim. Delicate adjustment for heat and cold is effected by trial, the chronometer being subjected to varying temperatures in carefully regulated ovens and refrigerating boxes. The weights are moved along the rim until gain or loss is least, no matter what the thermometer may indicate.

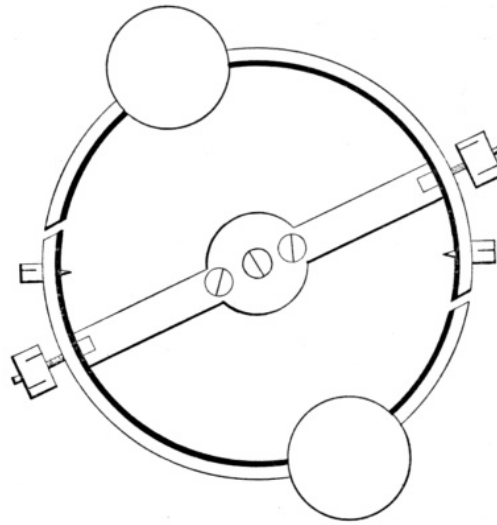

The Chronometer Balance

The rim itself is composed of strips of brass and steel firmly brazed together. The outer part is brass, and the inner steel, of one half the thickness of the brass. With a rise of temperature, brass tends to expand more rapidly than steel; and by overpowering the steel, it bends the free ends of the rim inward, practically making the balance a little smaller. When the temperature falls, the balance enlarges again slightly. Near the middle of each half rim is a weight, which can be moved along the rim. Delicate adjustment for heat and cold is effected by trial, the chronometer being subjected to varying temperatures in carefully regulated ovens and refrigerating boxes. The weights are moved along the rim until gain or loss is least, no matter what the thermometer may indicate.

Time on Board Ship.—The time for everybody on board ship is regulated according to an arbitrary division adopted by navigators. The day of 24 hours is subdivided into six periods of four hours each, called *watches*. A watch is a convenient interval of duty for both officers and sailors; and this division of the ship's day is recognized by mariners the world over. The period from 4 P.M. to 8 P.M. is subdivided into two equal parts, called *dogwatches*; so that the seven watches of the ship's day, with their names, are as follows:—

The first watch,	from 8 P.M.	to 12 midnight.
The mid watch,	from 12 midnight	to 4 A.M.
The morning watch,	from 4 A.M.	to 8 A.M.
The forenoon watch,	from 8 A.M.	to 12 noon.
The afternoon watch,	from 12 noon	to 4 P.M.
The first dogwatch,	from 4 P.M.	to 6 P.M.
The second dogwatch,	from 6 P.M.	to 8 P.M.

The dogwatches differ in length from the regular watches, so that during the cruise the hours of duty for officers and men may be distributed impartially through day and night. Every watch of four hours is again divided into eight periods, each a half hour long, called *bells*. Each watch, except the dogwatches, therefore, continues through eight bells. The end of the first half-hour period of each watch is called *one bell*; of the second, *two bells*; of the third, *three bells*; and so on. Four bells, for example, corresponds to two o'clock, six o'clock, and ten o'clock; and seven bells to half past three, half past seven, and half past eleven, whether A.M. or P.M., of time on shore.

Low Tide delays the Ship's Departure.—Another point of contact between astronomy and navigation was well illustrated as the ship was about to depart. The tide was low, and she must wait a few hours until it rose. The times of high tide and low tide are predicted by calculations based in large part upon the labors of astronomers. The mere phenomena of tides are inquired into here, leaving the explanation of them to a subsequent chapter on universal gravitation.

The Tides in General.—A visit of one day to the seashore is sufficient to show the rising and falling of the ocean. It may happen that in the morning a walk can be taken along the broad, sandy beach, which later in the day will be covered under the risen waves. Or rocks where one sat in the morning are in the afternoon buried underneath green water. A single day will always show these changes; and another single day will exhibit similar fluctuations, only at other hours. The photographic picture opposite indicates a typical range of the tides, and horizontal markings on the rocks show the level of high tide, seven or eight feet above water level in the illustration. A week's stay at the shore will establish the regularity of variation. High tide at ten o'clock in the morning means low tide a little after four in the afternoon, or approximately six hours later, high tide occurs again soon after ten in the evening, and low tide at about half past four in the morning. So there are two high tides and two low ones in every 24 hours, or more properly, in nearly 25 hours. And if it is high tide one morning at ten o'clock, the next day full tide will occur at about eleven o'clock. So that gradually the times of high and low tide change through the whole 24 hours, lagging about 50 minutes from one day to another.

The Tides defined.—A tide is any bodily movement of the waters of the earth occasioned by the attraction of moon and sun. The word *tide*, as used by the sailor, often refers to the nearly horizontal flow of the sea, forth and back, in channels and harbors. To the astronomer, the word *tide* means a vertical rise and fall of the waters, very different in different parts of the earth, due to the westerly progress of the tidal wave round the globe.

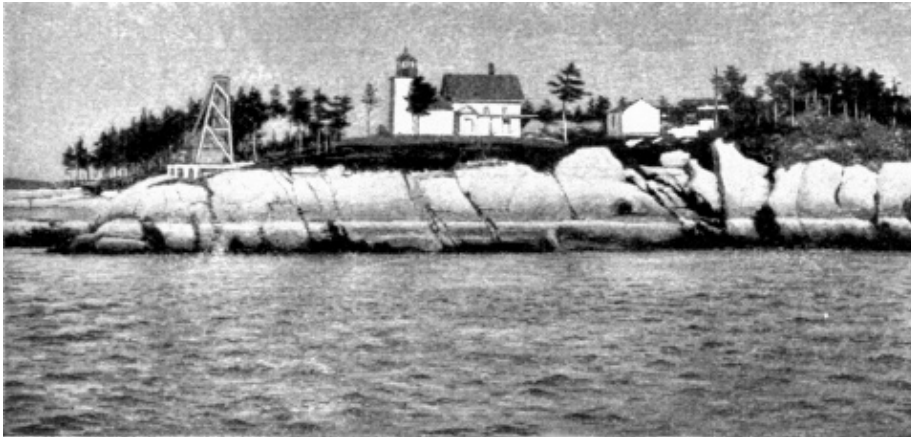

At Low Tide—(Markings on Rocks are Level of High Tide)

The time of highest water is called high tide; and of lowest water, low tide. From high tide to low is termed ebb tide; from low to high, flood tide. Near new moon and full moon each month (as explained on page 339) occur the highest and lowest tides, termed spring tides. As the moon comes to new and full every month, or lunation, and as there are about $12\frac{1}{2}$ lunations in the year, there are nearly 25 periods of spring tides annually. Spring tides have nothing to do with the season of spring. Intermediate and near the moon's first and third quarters, the ebb and flood, being below the average, are called neap tides (*nipped*, or restricted tides). So valuable to the navigator is a knowledge of the times of high tide and low tide at all important ports, that these times are carefully calculated and published by government authority a year or two in advance. This duty in our country is fulfilled by the United States Coast and Geodetic Survey, a bureau of the Department of Commerce and Labor.

Direct and Opposite Tides.—The tide formed on the earth as a whole is made up of two parts: (*a*) the direct tide, which is the bulge or protuberance, or tidal wave on the side of the earth toward the tide-raising body, and (*b*) the opposite tide, which is the tidal wave on the side away from it. The figure shows a section of the earth surrounded as it always is by such a double tide. Gravitation, as explained in the chapter on that subject, elongates the watery envelope of the earth very slightly in two opposite directions. Thus the earth and its waters are a prolate spheroid; that is, slightly football-shaped. As the earth turns round on its axis eastward, this watery bulge seems to travel from east to west, in the form of a tidal wave twice every 25 hours. To illustrate: It is as if a large cannon ball were turning on the shorter axis of a football and inside

of it. If the waters could at once respond to the moon's attraction, the time of high tide would coincide with the moon's crossing the upper or lower meridian. But on account of inertia of the water, the comparatively feeble tide-producing force requires a long time to start the wave. The time between moon's meridian transit and arrival of the crest of the tidal wave is called the *establishment of the port*. This is practically a constant quantity for any particular port, but is different for different ports. It is $8\frac{1}{4}$ hours for the port of New York.

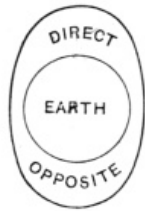
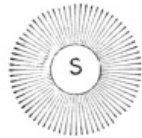

Direct and Opposite
Tides

Only the Wave Form travels.—Guard against thinking that the tides are produced by the waters of the ocean traveling bodily round the globe from one region to another. The deep waters merely rise and fall, their advance movement being very slight, except where the tidal wave impinges upon coasts. It is only the form of the wave that advances westerly. Illustrate by extending a piece of rope on the floor and shaking one end of it. A wave runs along the rope from one end to the other; but only the wave form advances, the particles of the rope simply rising and falling in their turn. So with the waters of the tidal wave.

Movement of the Tidal Wave.—Originating in the deep waters of the Pacific Ocean, off the west coast of South America, the tidal wave travels westerly at speeds varying with the depth of the ocean. The deeper the ocean, the faster it travels. During this progressive motion of a given tidal wave it combines with other and similar tidal waves, so that the resultant is always complex. In about 12 hours it reaches New Zealand, passes the Cape of Good Hope in 30 hours, where it unites with (a) the direct tide in the Atlantic off Africa, and (b) a reversed wave, which has moved easterly round Cape Horn into the Atlantic. The united wave then travels northwesterly through the Atlantic Ocean about 700 miles hourly, reaching the east coast of the United States in 40 hours. On account of the irregular contour of ocean beds, there is never a steadily advancing tidal wave, as there would be if the oceans covered the entire earth to a uniform depth. Tidal charts of the oceans have drawn upon them irregularly curved lines connecting places where crests of tidal waves arrive at the same hour of Greenwich time. These are called cotidal lines.

Extent of Rise and Fall.—The extent of rise and fall of the tide varies in different places. Speaking generally, in mid-ocean the difference between high and low water is between two and three feet, while on the shores of great continents, especially in shallow and gradually narrowing bays, the height is often very great. The average spring tide at New York is about $5\frac{1}{2}$ feet, and at Boston about 11. In the Bay of Fundy, spring tides rise often 60 feet, and sometimes more. The tide also rises in rivers, but less as the distance from the river's mouth increases, where it is more and more neutralized by the current. A tide of a few inches advances up the Hudson River from New York to Albany in about nine hours. It is possible for a river tide to rise to a higher level than that of the ocean itself, where the momentum of the wave is expended in raising a relatively small amount of water, on the principle of the hydraulic ram. At Batsha in Tonquin there is no tide whatever, because the waters enter by two mouths or channels of unequal depth and length, the lagging in the longer channel being about six hours more than in the shorter one.

Tides in the Great Lakes.—Theoretically there are tides in large bodies of inland water also; but even the largest lakes are too small for their share in the moon's tide-producing force to be very pronounced. A tide of less than two inches occurs in Lake Michigan at Chicago; and in the Mediterranean there is a slight tide of about 18 inches. Height of the tide in landlocked seas depends in part upon the ratio of the length of such seas (east and west), to the diameter of the earth. Meager tides like these are often completely masked by the tides which local winds raise.

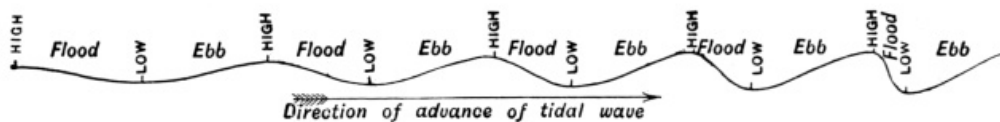

Ebb Tide always longer than Flood Tide

Duration of Flood and Ebb Tides.—In mid-ocean the tidal wave rises much less than on the coasts; for on reaching shallow water, friction retards the wave, shortening its length from crest to crest, and greatly increasing the height of the tide, particularly if the advancing wave is forced to ascend a somewhat shallow and gradually narrowing channel.

Figure 8.6 illustrates this change in the section of a tidal wave advancing toward a coast on the right. The crest of the wave is farther from the bottom and therefore less retarded by friction, so that it advances more rapidly, and makes the wave steeper on its front than on its after slope. Under all ordinary conditions, then, flood tide is evidently shorter in duration than ebb tide. At Philadelphia, for example, where the difference is accentuated by coast configurations ebb tide

is nearly two hours longer than flood tide. An extreme case is that known as the tidal bore, in which the advancing slope of the tidal wave in certain favorably conditioned rivers becomes perpendicular. The crest then topples over, and flood tide takes the form of a swiftly advancing breaker; in only a few minutes the waters rise from low to high, and ebb tide consumes rather more than 12 hours following. This strong tidal wave surmounting the seaward current of the river, sometimes piling up a cascade of overlapping waves, is well marked in the Seine, the Severn, and the Ganges.

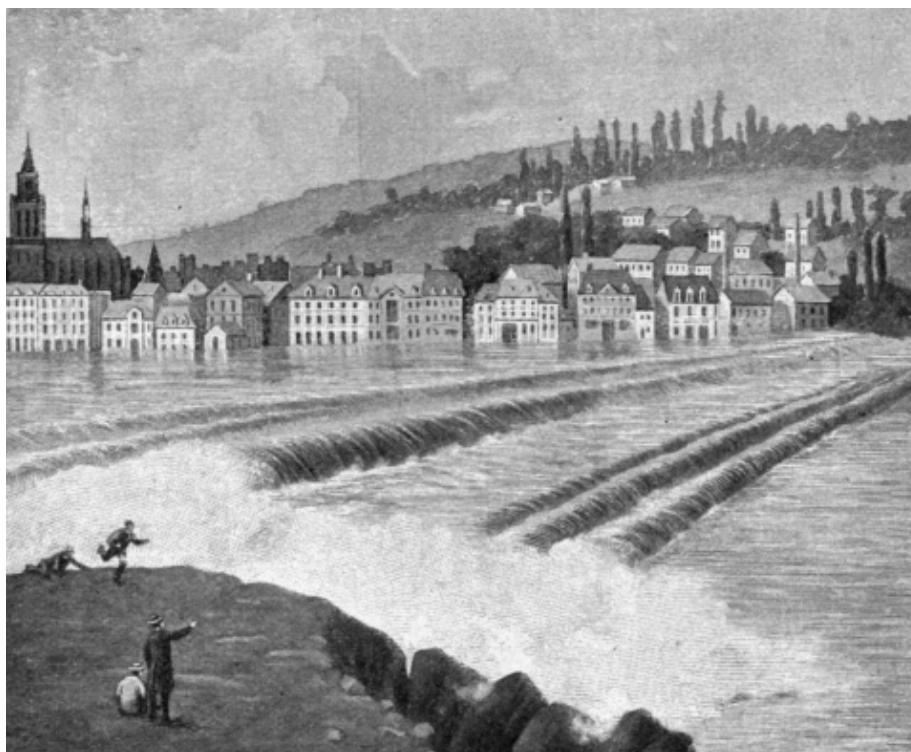

Tidal Bore at Caudebec, a town on the Seine (according to Flammarion)

Diurnal Inequality of the Tides.—If the earth's equator coincided with the plane of the moon's orbit, and if there were no obliquity of the ecliptic, evidently the tide-producing force of both sun and moon would always act perpendicular to the earth's axis. The direct tide and the opposite tide would then be symmetrical with reference to the equator; and, generally speaking, equal latitudes would experience equal tides. When, however, the moon is at her greatest declination north, the direct tide is highest at those north latitudes where the moon culminates at the zenith; while the opposite tide is slight in the northern hemisphere, but highest at

the antipodes of the direct tide, or in south latitudes equal to the north declination of the moon. This difference in height of the two daily tidal waves is called the diurnal inequality.

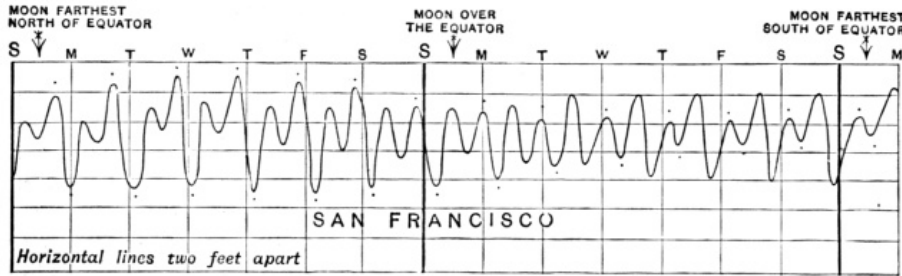

Diurnal Inequality of the Tides at San Francisco

In the case of lunar tidal waves, the diurnal inequality becomes zero twice each month, when the moon crosses the celestial equator; and the diurnal inequality of the solar tide vanishes at the equinoxes. But this obvious difference in height of the two daily tides is greatly modified by coast configurations and other conditions. The illustration above is plotted from a fortnight's record of the tide gauge at San Francisco. The wave line represents the rise and fall of the surface of the water; the distance from one horizontal line to another being two feet. Vertical lines divide off periods of 24 hours, the succession of days being indicated at the top. The difference between direct and opposite tide is very marked each day, except when the moon is near the equator, when the diurnal inequality is much reduced. Small dots are placed adjacent to the highs and lows of the direct tide, which illustrate the diurnal inequality excellently, having a very wide range in northern latitudes when the moon culminates nearest the zenith, a medium range when she is crossing the equator, and a minimum range when her south declination is near a maximum.

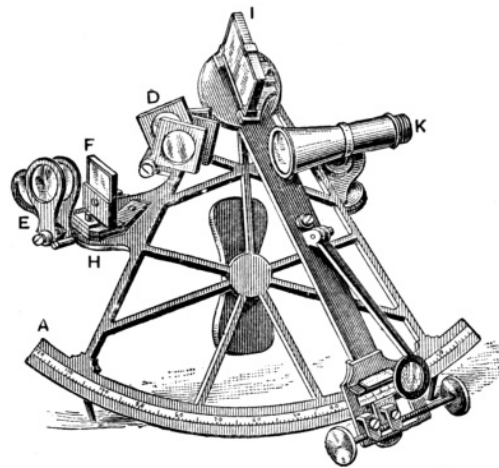

Sextant for measuring Angles

The Sextant.—The sextant is a light, portable instrument arranged for measuring conveniently

arcs of a great circle of the celestial sphere in any plane whatever. With it are made the astronomical observations which are calculated by means of the Nautical Almanac. Next to the compass, the sextant is more frequently used than any other instrument; for by the angles measured with it, the navigator finds his position upon the ocean from day to day.

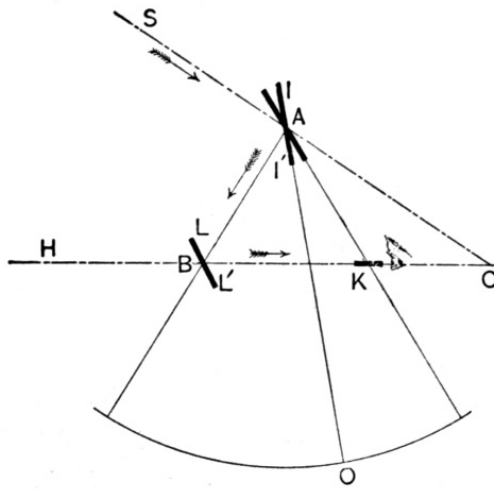

How Angles are measured

In navigation the sextant is generally used in a vertical plane; that is, in measuring altitudes of heavenly bodies. The sextant was invented by Hadley in 1730. A finely graduated arc A , of 60° (whence the origin of its name) has an arm (from I downward toward the right) sliding along it, as the radius of a circle would, if pivoted at the center and moved round the circumference. Rigidly attached to the pivot end of this moving arm, and at right angles to the plane of the arc, is a mirror, I , called the index glass. Also firmly attached to the frame of the arc is another mirror, FH , only partly silvered, called the horizon glass. A telescope K , parallel to the frame and pointed toward the center of horizon

glass, helps accuracy of observation. Shade glasses of different colors and density (at D and E) make it possible to observe the sun under all varying conditions of atmosphere—haze, fog, thin cloud, or a perfectly transparent sky; for that orb is, of all heavenly bodies, the most frequently observed in navigation. Shade glasses tone down the light, whatever its intensity, and farther increase the accuracy of observation. A clamp and tangent screw (below the arc) facilitate the details of actual observation; antecedent to which, however, the adjustments of the sextant must be carefully made. The most important are these: when the arm is set at the zero of the arc, the plane of the principal mirror also must pass through the zero of the arc; and the horizon glass must be parallel to the mirror, both being perpendicular to the plane of the graduated arc or limb. The horizon line is CH (Figure 8.10), and the heavenly body is in the direction CS . The distant horizon is seen by the eye through the telescope at K , and its line of sight passes through the upper or unsilvered part of the horizon glass LL' . When the arm is at 0° , the index glass stands in the direction AK but when an altitude, HCS , is to be measured, the arm is pushed along the limb to O . The index glass then stands

in the position II' , so that light will travel in the direction of the arrows $SABK$. After reflection from the two mirrors, the object will appear in contact with the horizon. The arc is read, and the observation is complete. As the angle between index and horizon glasses is half the angle measured, the limb is graduated at the rate of 1° for each actual $30'$.

Finding the Latitude at Sea.—Usually the first astronomical observation at sea will be made for the purpose of finding the latitude of the ship. There are many methods, but all are based on the fundamental principle already given, that the latitude is always equal to the altitude of the celestial pole. Usually latitude is found by observing the altitude of some celestial body when crossing the meridian on the opposite side of the zenith from the pole. So it is referred directly to the equator, whose distance from the zenith always equals the latitude also.

For example: a few minutes before noon, the navigator will begin to observe the sun's altitude with the sextant, repeating the observation as long as the altitude continues to increase. When the sun no longer rises any higher, it is on the local meridian. The time is high noon, or apparent noon. The officer then gives the order 'Make it Eight Bells,' and proceeds to ascertain the latitude from the observation just made. The diagram on page 74 elucidates the principle involved. Once the meridian zenith distance is found by observation, latitude is ascertained from it by the same principle, whether at sea or on land.

Finding the Longitude at Sea.—As on land, so at sea, finding the longitude of a place is the same thing as finding how much the local time differs from the time of a standard meridian. The prime meridian of Greenwich is almost universally employed in navigation. First, then, local time must be found.

A portable instrument like the sextant must be used, because of the continual motion of the ship. With it the navigator observes the altitude of some familiar heavenly body toward the east or west. This operation is called 'taking a sight.' Most often the sun is observed for this purpose—either early in the morning, or late in the afternoon. The nearer the time of its crossing the prime vertical, the better, because its altitude is then changing most rapidly, and so the observation can be made more accurately. First, the latitude must be known. Then the local time is worked out by a branch of mathematics called spherical trigonometry. This computation forms part of the everyday duty of the navigator; and as simplified for his use, it is an arithmetical process, greatly facilitated by specially prepared tables of the relation of the quantities involved. These are three: the altitude of the body (given by observation), its declination (obtained from the Nautical Almanac), and the latitude of the ship. Having found the local time, take the difference between it and the chronometer (Greenwich) time; the result

is the longitude sought. If local time is greater than Greenwich time, longitude is east; west, if less. There are many methods of ascertaining longitude, and each navigator, as a rule, has his favorite. Sumner's method is generally conceded to be the best. Except in overcast weather, the navigating officer will usually feel sure of the position of his ship within two miles of latitude, and three to five miles of longitude. It is difficult to find her position nearer than this unless the observations are themselves made with exceptional care, and the errors of sextant and chronometer have been specially investigated with greater precision than is either usual or necessary. Once the position of the ship is known, it is plotted on the chart, and the proper course is calculated and the ship maintained on it by constant watch of the compass, a delicate magnetic instrument by which true north can always be found.

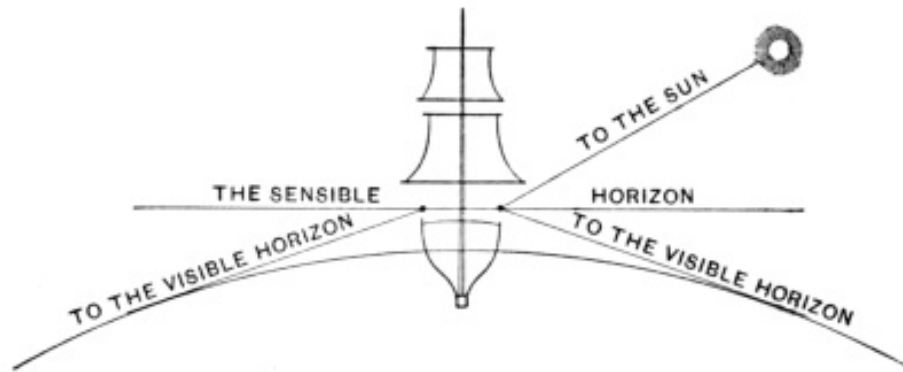

Dip of the Horizon

Dip of the Horizon.—In calculating any observation of altitude of a heavenly body taken at sea, a correction for dip of the horizon is always applied. Dip of the horizon is the angle between a truly horizontal line passing through the observer's eye, and the line of sight to his visible horizon, or circle which bounds the view.

As the surface of our globe may be regarded as spherical (always so considered in practical navigation), it must curve down from the ship equally in every direction. The figure shows this clearly. Also, as altitude is angular distance above the sensible horizon, it is apparent that every observation of altitude must be diminished by the correction for dip. Plainly, too, dip is greater, the higher the deck of the ship from which the observation is taken. If the deck is 10 feet above the water, the correction for dip is about three minutes of arc; if 18 feet, about four minutes. From the elevation of a deck of ordinary height, the visible horizon is about seven miles distant in every direction; and generally speaking a ship will never be visible at more than double this distance, even with a telescope.

Usually an approaching ship will not become visible until about eight miles away; but the condition of the atmosphere, the character of the distant ship's rigging, the way in which sunlight falls upon it, and the rising and falling of both ships on the waves,—all affect this distance materially.

Where does the Southern Cross become Visible?—A question of perennial interest to the southward voyager. Its answer may come appropriately now, but first it is necessary to know how far this famous asterism is south of the celestial equator; that is, its south declination. Consulting charts of the southern heavens, we find that the central region of the Cross is in south declination 60° . Consequently, it will just come to the southern horizon when the latitude is equal to $90^\circ - 60^\circ$; that is, 30° . But haze and fog near the sea horizon will usually obscure the Cross until a latitude six or seven degrees farther south has been reached. Good views of it may be expected at the Tropic of Cancer, and they improve with the journey farther south. It must, however, be said that the Southern Cross is a disappointment, for it is by no means so striking a configuration as the Great Bear.

Where will the Sun be overhead at Noon?—Not before we reach the tropics, because the sun never can pass overhead at any place whose latitude exceeds $23\frac{1}{2}^\circ$.

But in Chapter IV it was shown that the latitude is always equal to the declination of the zenith. If, therefore, it is desired to find the place where the sun will pass through the zenith at noon, we must first ascertain the sun's declination from the almanac (or approximately from page 75). Then it is apparent that the zenith sun will be met at noon, when the latitude of the ship is exactly the same as the sun's declination. From vernal equinox to autumnal equinox, when the sun is all the time north of the equator, the ship must be in the northern hemisphere, in order that the sun may pass directly over her. And, in general, the sun will pass through the ship's zenith on the day when her latitude is the same in sign and amount as the declination of the sun. For example, on the 2d of March the sun will be overhead at noon to all ships which are crossing the

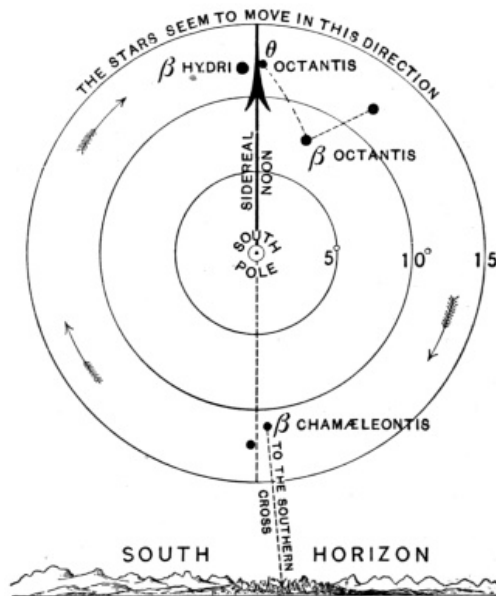

Apparent Motion of the South Polar Heavens

7th parallel of south latitude, because the sun's declination is 7° south on that day.

In Southern Latitudes.—Looking northward, or away from the pole now visible, the stars appear to rise on our right hand, passing up over the meridian, and setting on our left. They still rise in the east and set in the west. But looking poleward, the stars circulate round the pole clockwise by diurnal motion, as indicated by arrows in the diagram adjacent. The south pole of the heavens rises one degree above the south horizon for every higher degree of south latitude. If the south pole were actually reached, all the stars south of the equator would be perpetually visible, and no star of the northern hemisphere could ever be seen. But the region overhead in the sky would not be conspicuously marked, as at the north pole, by Polaris and the Little Bear, because there is no conspicuous south polar star. In fact, there is no star as bright as the fifth magnitude within the circle drawn five degrees from the pole. The pair of stars in the Chamæleon, here shown underneath the pole, are of the fifth magnitude, and Beta Hydri is a third magnitude star. All are easy to find from the Southern Cross, which is $2\frac{1}{2}$ times farther from the pole than the Chamæleon stars.

Rounding Cape Horn to San Francisco.—On the remainder of our ship's voyage to latitude about 57° south, where she rounded the Cape, little or nothing new arose, involving any astronomical principle. The Southern Cross passed practically through the zenith, because the latitude was nearly equal to the declination of the asterism. The mild temperature nearly all the way was a verification of the opposite season in the southern hemisphere; for although it was winter (December, January, and February) at home, it was summer at the same time in south middle latitudes. Approaching the equator, it was observed that the inequality of day and night was gradually obliterated, quite independently of the season; for at the equator the diurnal arcs of all heavenly bodies are exact semicircles, no matter what their declination. At the equator, too, the brief twilight attracted attention—brief because the sun sinks at right angles to the horizon, instead of obliquely; so that it reaches as quickly as possible the angle of depression (18°) below the horizon, at which twilight ceases. On approaching the California coast, after a voyage of nearly four months, in which land had been sighted only once, it was a matter of much concern what the deviation of the chronometers might be from the rates established at New York. It was evidently not large, for the landfall off the Golden Gate was made without any uncertainty. On coming to anchor in San Francisco bay, it was easy to verify the chronometers, by observing the time signal at local noon (nearly) each day, which is given by the dropping of a large and conspicuous time-ball at exactly 8 h. 0 m. 0 s. P.M., Greenwich time. Comparison of the chronometers with this signal showed that the Greenwich time, as indicated by their dials, differed only 8 s. from the time-ball; so that the average daily deviation from the rate as determined at New York

was only $\frac{1}{16}$ of a second.

Standard Time Signals.—About a dozen time-balls are now in operation in the United States. The principal ones are dropped every day at noon, Eastern Standard or 75th meridian time, in Boston, New York, Philadelphia, Baltimore, and Washington; at noon, Central time, in New Orleans; and at noon, Pacific Standard, or 120th meridian time, in San Francisco.

The error of the signal, only a fraction of a second, is published in the local newspapers of the following day. In foreign countries, time signals are now regularly furnished, chiefly for the convenience of shipping, in about 125 of the principal ports of the world. In England and the British possessions, it is customary to give the time signal at 1 P.M., often by firing a gun. But the dropping of a time-ball (page 8) is the favorite signal throughout the world generally. In many of these ports, the time is determined with precision at a local observatory, and the time-ball may be utilized in re-rating the ship's chronometers.

Where does the Day change?—Imagine a railway girdling the world nearly on the parallel of New York, and equipped with locomotives capable of maintaining a speed of 800 miles an hour. At noon on Wednesday, start westward from New York; in about an hour, reach Chicago, in another hour Denver, in still another hour San Francisco. As these places are about 15° , or one hour of longitude from each other, evidently it will be Wednesday noon on arrival at each of them, and at all intermediate points, because the traveler is going westward just as fast as the earth is turning eastward; so it will be perpetual midday. Continue the journey westward at the same rate all the way round the earth. Night will not come because the sun has not set. So there can be no midnight. How, then, can the day change from Wednesday to Thursday? Will it still be Wednesday noon when the traveler returns to New York? On arrival there, 24 hours after he started, he will be told that it is Thursday noon. Where did the day change? Manifestly it must change somewhere once every 24 hours. Nearly the whole world has agreed to change at the 180th meridian from Greenwich, because there is little land adjacent to this meridian, and very few people are inconvenienced. Noon at Greenwich is midnight on the 180th meridian. If, therefore, a ship westward bound on the Pacific Ocean comes to this meridian at midnight of, say, Wednesday, on crossing that meridian it is immediately after 12 A.M. of Friday. As a rule ships will not arrive at the 180th meridian exactly at midnight; but this does not affect the principle involved: a whole day, or 24 hours, is dropped or suppressed in every case.

If, for example, it is Friday afternoon at four o'clock when this line is reached, it becomes Saturday immediately after 4 P.M. as soon as the 180th meridian is

crossed. This experience, familiar to all trans-pacific voyagers, is called 'dropping the day.' If a person born on the 29th of February were crossing the Pacific Ocean westward on a leap year, and should arrive at the 180th meridian at midnight on the 28th of February, the change of day would bring the reckoning of time forward to the first of March; so that he would have the novel experience of living eight years with strictly but a single birthday anniversary. Journeying eastward across the 180th meridian, the reverse of this process is followed, and 24 hours are subtracted from the reckoning. If, for example, the ship reaches this meridian at 10 A.M. Wednesday, it immediately becomes 10 A.M. Tuesday on crossing it. When, in 1867, the United States purchased Alaska, it was found necessary to set the official dates of the new territory forward 11 days (page 143), because the reckoning had been brought eastward from Russia, its former owner. Russian dates were then 12 days behind ours; but the difference in Alaska was only 11 days, because it is east of the 180th meridian.

Time at Home compared with Time in Japan.—The arrival of a ship at Yokohama will usually be cabled to her owners,—in New York very probably. Sending such a message naturally gives rise to inquiry as to when it will be received. The table of 'Standard Time in Foreign Countries' (page 109) shows that the time service of the Japanese Empire corresponds to the 135th meridian (9 hours) east of Greenwich. As Eastern Standard time is five hours slower than Greenwich time, evidently Japan is 10 hours west of our standard meridian; and its standard time would be 10 hours slower than ours, except for the change of day. On account of this, the standard time of Japan is 24 hours in advance, minus 10 hours slower; that is, 14 hours in advance of Eastern Standard time.

The same result is reached, if we go round the world eastward to Japan, thereby avoiding the troublesome 180th meridian. The Eastern Standard meridian is five hours west of Greenwich, and Japan is nine hours east of Greenwich. So that it is 14 hours east of us; that is, its time is 14 hours faster than ours. Allow six hours of actual time for the transmission of a cablegram from Yokohama to New York; if one were sent at 7 A.M. on Tuesday, it would be delivered at 11 P.M. on Monday, or seemingly eight hours before it was dispatched.

Great Circle Courses the Shortest in Distance.—In ocean voyages, in steamships, particularly in crossing the Pacific, the captain will usually choose the course which makes his run the shortest distance between the two ports. Imagine a plane through the center of the earth and both ports; the arc in which this plane cuts the earth's surface is part of a great circle. This arc, the shortest distance between the two ports, is called a great circle course. If both are on the equator, the equator itself is the great circle connecting them; and the ship goes due east or due west, when

sailing a great circle course from one to the other. If, however, the ports are not on the equator, but both in middle latitudes, as San Francisco and Yokohama, the parallel of latitude (which nearly joins them and is a small circle of the globe) has a greater degree of curvature than the great circle, which clearly must pass through much higher latitudes. As shown by the diagram of the two arcs, seen from above the pole, the great circle arc, lying farther north, deviates less from a straight line than the corresponding arc of a parallel (upper curve). It is therefore a shorter distance.

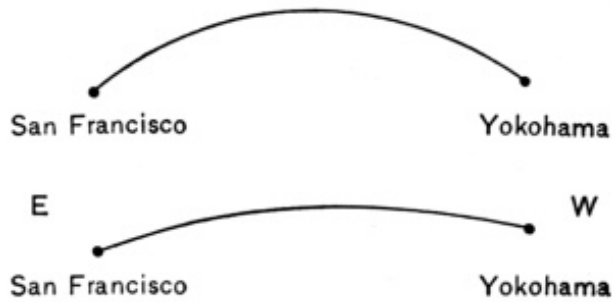

Great Circle Course the Shortest

Consequently ships sailing great circle courses will usually pass through latitudes higher than either the point of departure or destination.

Before passing on to a study of sun, moon, and planets, we digress to consider the instruments by whose aid our knowledge of these orbs has mainly been acquired.

Chapter IX

The Observatory and its Instruments

Observatories are buildings in which astronomical and physical instruments are housed, and which contain all the accessories for their convenient use. Most important of all instruments of a modern observatory are telescopes and spectroscopes.

Astronomy before the Days of Telescopes.—The progress of astronomy has always been closely associated with the development and application of mechanical processes and skill. Earlier than the seventeenth century, the size of the planets could not be measured, none of their satellites except our moon were known, the phases of Mercury and Venus were merely conjectured, and accurate positions of sun, moon, and planets among the stars, and of the stars among themselves, were impossible—all because there were no telescopes. More than a half century elapsed after the invention of the telescope before Picard combined it with a graduated circle in such a way that the measurement of angles was greatly improved. Then arose the necessity for accurate time; but although Galileo had learned the principles governing the pendulum, astronomy had to wait for the mechanical genius of Huygens before a satisfactory clock was invented, about 1657. Nearly all the large reflecting telescopes ever built were constructed by astronomers who possessed also great facility in practical mechanics; and the rapid and significant advances in nearly all departments of astronomy during the last half century would not have been possible, except through the skill and patience of glass makers, opticians, and instrument builders, whose work has reached almost the limit of perfection. Before 1860, if we except the meager evidence from meteoric masses of stone and iron, some of which had actually been seen to fall, it is proper to say that our ignorance of the physical constitution of other worlds than ours was simply complete. The principles of spectrum analysis as formulated by Kirchhoff led the way to a knowledge of the elements composing every heavenly body, no matter what its distance, provided only it is giving out light intense enough to

reach our eyes. But since Newton, no necessary step had been taken along this road until the way to this signal discovery was paved by the deftness of Wollaston, who showed that light could not be analyzed unless it is first passed through a very narrow slit; and of Fraunhofer, the eminent German optician, who first mapped dark lines in the spectrum of the sun. So, too, in our own day the power of telescope and spectroscope has been vastly extended by the optical skill and mechanical dexterity of the Clarks and Rowland, Hastings and Brashear, all Americans.

Best Sites for Observatories.—An observatory site should have a fairly unobstructed horizon, as much freedom from cloud as possible, good foundations for the instruments, and a very steady atmosphere.

All of these conditions except the last are self-evident. To realize the necessity of a steady atmosphere, look at some distant out-door object through a window under which is a register, a stove, or a radiator. It appears blurred and wavering. Similarly, currents of warm air are continually rising from the earth to upper regions of the atmosphere, and colder air is coming down and rushing in underneath. Although these atmospheric movements are invisible to the eye, their effect is plainly visible in the telescope as blurring, distortion, quivering, and unsteadiness of celestial objects seen through these shifting air strata of different temperatures, and consequently of different densities. The trails on photographic star plates, exposed with the camera at rest, make this very evident. That a perfect telescope may perform perfectly, it must be located in a perfect atmosphere. Otherwise its full power cannot be employed. All hindrances of atmosphere are most advantageously avoided in arid or desert regions of the globe, at elevations of 3000 to 10,000 feet above sea level. On the American continent have been established several observatories at mountain elevation, the most important being the Boyden Observatory of Harvard College, Peru (8000 feet); Carnegie Solar Observatory, California (6000 feet); and the Lick Observatory, California (4000 feet). Higher mountains have as yet been only partially investigated; and it is not known whether difficulties of occupying them permanently would more than counterbalance the gain which greater elevation would afford.

A Working Observatory.—Chief among exterior features is the great dome, usually hemispherical, and capable of revolving all the way round on wheels or cannon balls. The opening through which the telescope is pointed at the stars is a slit, two or three times as broad as the diameter of the object glass. The slit opens in a variety of ways, often as in the above picture, by sliding to one side on pivots and rollers. Solidly built up in the center of the tower is a massive pier, to support the telescope, wholly disconnected from the rest of the building. By means of the universal or equatorial mounting (page 46), the open slit, and the revolving dome, the telescope is readily directed toward any object in the sky. Observatories are provided with a meridian room, with a clear opening from north to south, in which a transit instrument or meridian circle is mounted.

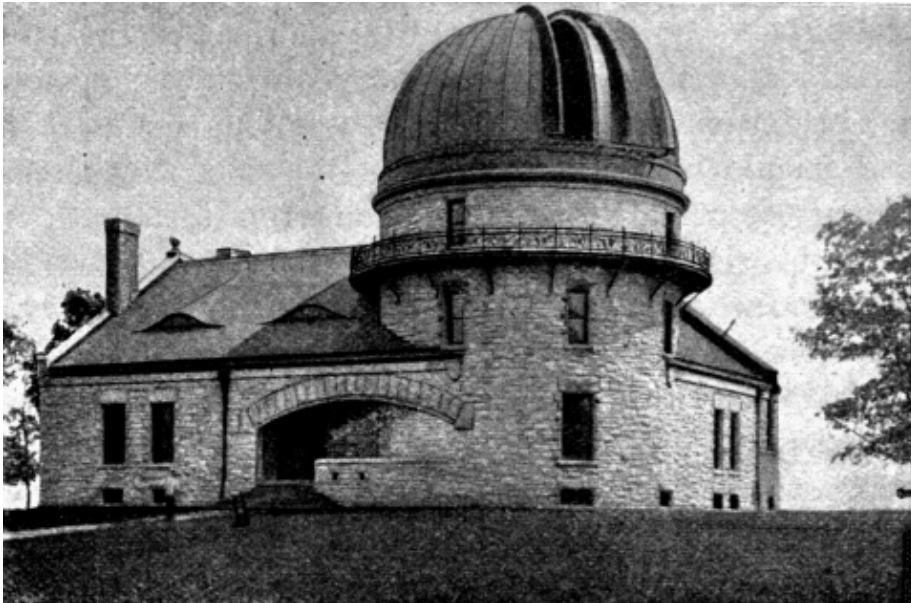

The Dearborn Observatory at Evanston, Professor Philip Fox, Director

Part of it shows at the right of the tower. Here also are the chronograph, and clock or chronometer for recording transits of the heavenly bodies. Modern observatories are provided with a library and computing room, a photographic dark room, and other accessories of equipment, varying with the nature of their work. The best type of observatory construction utilizes a minimum of material, so that very little heat from the sun is stored in its walls during the day, and local disturbance of the air in the evening, caused by radiation of this heat, is but slight. Louvers and ivy-grown walls contribute much to this desirable end. It is considered best to house each instrument in a suitable structure of its own, as remote as possible from many or massive buildings.

Instruments classified.—Instruments used in astronomical observatories are divided into three classes:—

(a) *Telescopes*, or instruments for aiding or increasing the power of the human eye. There are two kinds, the dioptric, or refracting telescope, and the catoptric, or reflecting telescope.

(b) *Instruments for measuring angles*. These, also, are subdivided into two kinds; the arc-measuring instruments, like graduated circles, for measuring very large arcs, the micrometer for measuring very small ones, and the heliometer for measuring arcs intermediate in value, as well as very small ones. The second class of instruments concerned in the measurement of angles are transit instruments for observing time (measured by the uni-

form angular motion of a point on the equator), chronographs for recording the time, clocks and chronometers for carrying the time along accurately and continuously from day to day.

(c) *Physical instruments*, of which many varieties are employed in most modern observatories, for investigating the light and heat radiated from celestial objects. Chief among them are spectroscopes, or light-analyzing instruments, of which there are numerous forms, adapted to especial uses. Heliostats are plane mirrors moved by clockwork, for the purpose of throwing a reflected beam of light from a heavenly body in a constant direction. The bolometer is an exceedingly sensitive measurer of heat, and the thermopile is used for the same purpose, though much less sensitive. The photometer is used for measuring the light of the heavenly bodies. The actinometer and pyrliometer are physical instruments used in measuring the heat of the sun. The photographic camera is extensively employed at the present day, to secure, by means of telescope, photometer, spectroscope, and bolometer, permanent record, unaffected by small personal errors to which all human observations are subject.

Telescopes.—The telescope is an optical instrument for increasing the power of the eye by making distant objects seem larger and therefore nearer.

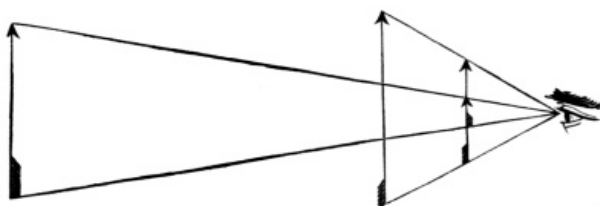

Illustrating the Visual Angle

It does this by apparently increasing the visual angle. A distant object fills a relatively small angle to the naked eye, but a suitable combination of lenses, by changing the direction of rays coming from the object, makes it seem to fill a much larger angle, and therefore to be nearer. Such a combination is called a telescope. The parts of all telescopes are of two kinds,—optical and mechanical. The optical parts are lenses, or mirrors, according to the kind of telescope; and the mechanical parts are tubes, and various appliances for adjusting the lenses or mirrors, including also the machinery for pointing the tube. All the different lenses used in telescopes are illustrated in Figure 9.3 (in section). One principle is the same in all telescopes: a lens or mirror (called the objective) is used to form near at hand an image of a distant object; and between image and eye is placed a microscope (called the eyepiece or ocular) for looking at the image—just as if it were a fly's wing, or the texture of a feather. The point to which the lens

converges the parallel rays from a star is called the principal focus (Figure 9.4). The central ray, which passes through the centers of curvature of the two faces of the lens, traverses a line called the optical axis. The plane passing through the principal focus perpendicular to the optical axis is called the focal plane. Objective and eyepiece must be so adjusted and secured that their axes shall lie accurately in a single straight line. If objective and eyepiece could be held in this position by hand, also at the right distance apart, there would be no need of a tube. The tube is sometimes made square, as well as round, and is to be regarded simply as a mechanical necessity for keeping the optical parts of the telescope in proper relative position. Also the tube is of some use in screening extraneous light from the eyepiece, although that service is slight.

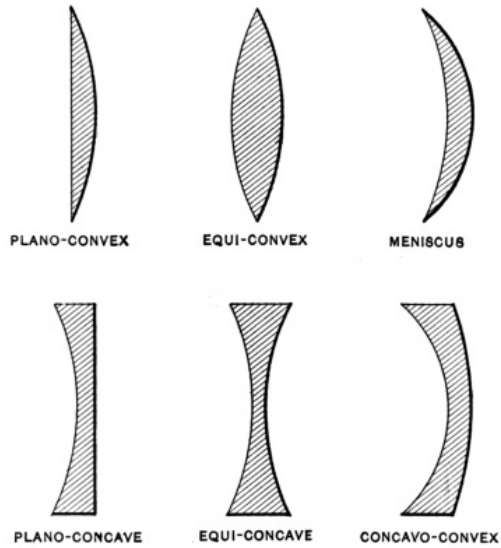

Lenses of Different Shapes (in Section)

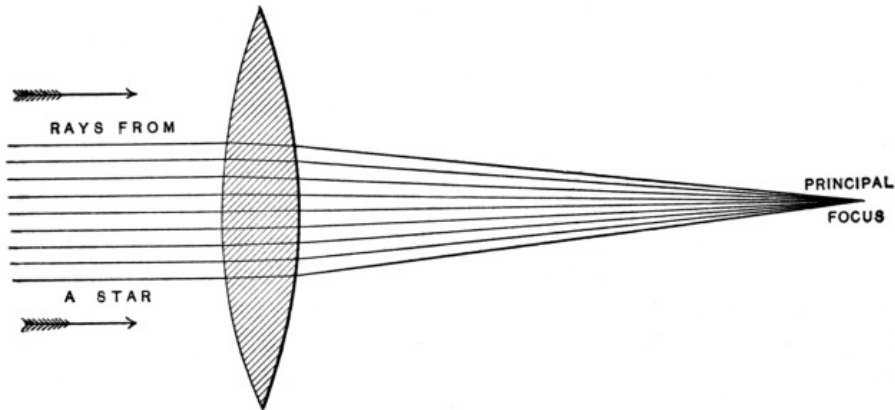

A Convex Lens refracts Parallel Rays to the Principal Focus

Kinds of Telescopes.—As to the principal kinds of telescopes: (a) If the objective is a lens (in its simplest form an equi-convex lens), then the image is produced by bending inward or refracting to the focus all rays of light which strike the lens; and the telescope is called a refractor, or refracting telescope.

This sort of instrument appears to have been first known in Holland, early in the seventeenth century; also it was invented by Galileo in 1609, and first used by him in observing the heavenly bodies. If a telescope is to perform properly, its object glass cannot be made of plate glass, because the eyepiece would reveal defects in it similar to those which the eye plainly sees in ordinary window glass. But the objective must be made of that finest quality known as optical glass. Through a perfect specimen of optical glass polished with parallel sides, a perpendicular ray of light will pass without appreciable refraction, and with very little absorption. (b) If the objective is a concave mirror or speculum, the image is then formed by reflection, to the focus, of all rays of light which fall upon the highly polished surface of the mirror, and the telescope is called a reflector, or reflecting telescope. The above figures show the principle involved, the angle of reflection being in every case equal to angle of incidence. An actual speculum may be regarded as made up of an infinite number of plane mirrors, arranged in a concave surface differing slightly from that of a sphere, and being in section a parabola (page 348). As shown in Figure 9.7 the focal point is halfway from mirror to center of curvature.

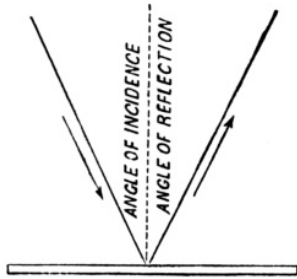

Angle of Reflection equals Angle of Incidence

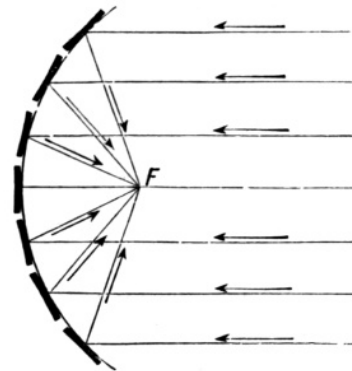

Concave Mirror reflects Parallel Rays to Focus

Growth of the Refracting Telescope.—An ordinary convex lens, in converging rays of light to a focus, must refract them, or bend them toward the axis of the lens. But light is commonly composed of a variety of colored rays, ranging through the spectrum from red to violet. Soon after the invention of the telescope Sir Isaac Newton discovered by experiment that prisms do not bend rays of different color alike; violet light is much more strongly refracted than red, and intermediate colors in different proportions, according to the kind of light employed. We may regard a lens as an infinitely large collection of tiny prisms. Clearly, then, a perfect telescope seemed to be an impossibility from the very nature of the case, because no single lens had power to gather all rays at a given focus, and could only scatter them along the axis—the focus for violet rays being

nearest the object glass, and for the red farthest from it. However, by grinding the convex lens almost flat, so that its focal length became very great, this seri-

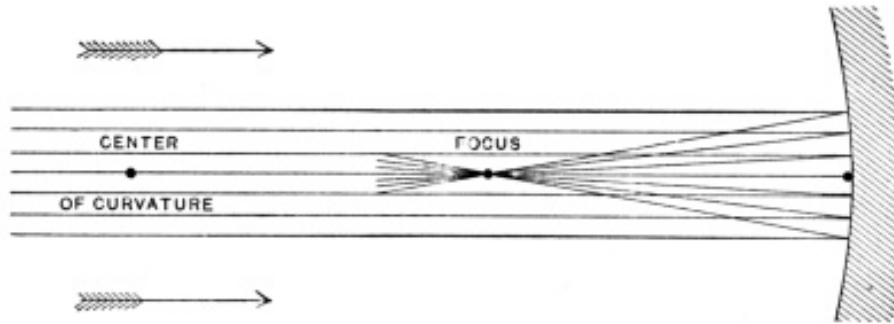

Focus halfway from Mirror to Center of Curvature

ous hindrance to development of the telescope was in part overcome, and many telescopes of bulky proportions were built during the 17th century, which were most awkward and almost impossible to manipulate. Sometimes the object glass was mounted in a universal joint on top of a high pole, and swung into the proper direction by means of a cord, drawn taut by the observer who held the eye-lens in his hand as best he could. Telescopes were built over 200 feet in length and

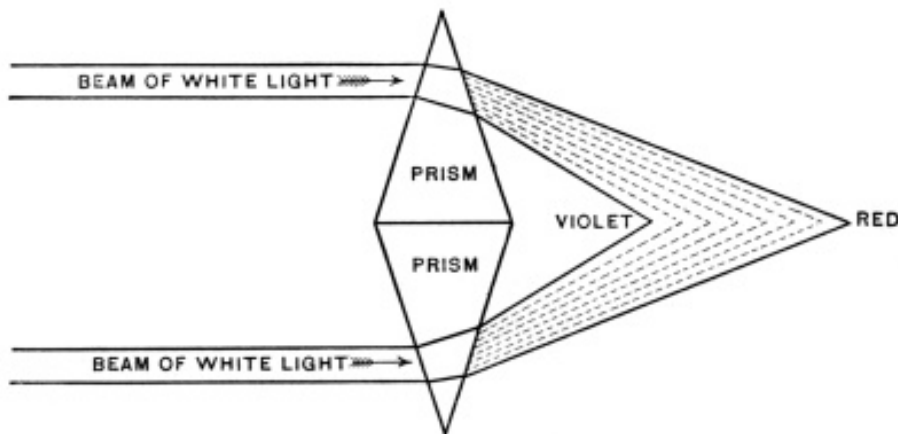

A Prism both refracts and disperses White Light

some observations of value were made with them, though at an inconceivable expenditure of time and patience. Newton concluded that it was hopeless to expect a serviceable telescope of this kind; so the minds of inventors were turned in other directions. **Why a Single Lens is not Achromatic.**—For the sake of clear explanation, regard the lens made up as in the last figure, so that a section

of it is the same as a section of two triangular prisms placed base to base. Let two parallel beams of white light fall upon the prisms as shown. Each will then be refracted toward the axis of the lens, and at the same time decomposed into the various colors of the spectrum. Red rays being refracted least, their focus will be found farthest from the lens. Violet rays undergoing the greatest angular bending, their focus will be nearest the lens. Foci for the other colors will be scattered along the axis as indicated. If we consider the actual lens, with an infinitude of faces or prisms, the effect is the same. So that, speaking generally, it cannot be said that the lens brings the rays of white light to any single focus whatever, and the image of a white object will be variously colored, wherever the eyepiece may be placed.

Principle of the Achromatic Telescope.—The two lenses of the objective must be of different kinds of glass: (1) a double-convex lens of crown glass, not very dense, which ordinarily the light passes through first; (2) a plano-concave lens of dense flint glass, usually placed close to the crown lens in small telescopes.

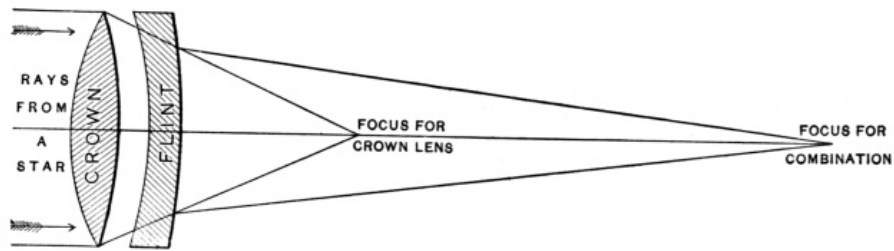

Illustrating Principle of Achromatic Object Glass

Similar prisms of these two kinds of glass bend the rays about equally; so that while the double-convex lens converges the rays toward the axis, the single or plano-concave diverges them again, by an amount half as great. So much for refraction merely: and it is plain from the above figure that the double object glass must have a greater focal length on account of the diverging effect of the flint lens. Next consider the effect of the two lenses as to dispersion of light, and the colors which each would produce singly. If we try equal prisms of the two kinds of glass, it is found that the flint, on account of its greater density, produces a spectrum about twice as long as the crown; therefore its dispersive power, prism for prism, is twice as great. Now a lens may be regarded as composed of a multitude of prisms,—a mosaic of indefinitely small prisms. Evidently, then, the plano-concave lens of flint glass, although it has only half the refracting power of the crown lens, will produce the same degree of color as the double-convex lens of crown glass. Therefore, the dispersion or color effect of the convergent crown lens is neutralized by the passing of the rays through the divergent flint lens, and

a practically colorless image is the result. Thus is solved the important problem of refraction without dispersion, opening the way for the great refractors of the present day.

History of the Achromatic Telescope.—Half a century after Newton, Hall in 1733 found that the color of images in the refractor could be nearly eliminated by making the object glass of two lenses instead of one, as just explained; a significant invention usually attributed to Dollond, who about 1760 secured a patent for the same idea which had occurred to him independently. Progress of the art of building telescopes was thus assured; and the only limitation to size appeared to be the casting of large glass disks. About 1840, these obstacles were first overcome by glass makers in Paris; but in the larger telescopes, a new trouble arose, inherent in the glass itself; for the ordinary form of double object glass cannot be made perfectly achromatic. An intense purple light surrounds bright objects, an effect of the secondary spectrum, as it is called, because dispersion or decomposition of the crown glass cannot be exactly neutralized by recomposition of the flint. Farther progress, then, was impossible until other kinds of glass were invented. Recent researches by Abbe under the auspices of the German Government have led to the discovery of many new varieties of glass, by combining which object glasses of medium size have already been made almost absolutely achromatic. Hastings in America and Taylor in England have met with marked success. Some of the new objectives are made of two lenses, and others of three; but there is great difficulty in procuring very large disks of this new glass.

Efficiency of Object Glasses.—This depends upon two separate conditions: (*a*) the light-gathering power of an objective is proportional to its area. Theoretically a 6-inch glass will gather four times as many rays as a 3-inch objective, because areas of objectives vary as the squares of their diameters. But practically the light of the larger glass will be somewhat reduced, because of the thicker lenses; for all glass, no matter how pure, is slightly deficient in transparency. In the same way, the light-gathering power of any lens may be compared with that of the naked eye. In the dark, the pupil of the average eye expands to a diameter of about $\frac{1}{5}$ inch. The ratio of its diameter to that of a 3-inch glass is 15, as in the illustration (reduced $\frac{1}{2}$); so a star in a 3-inch telescope appears nearly 225 times brighter than it does to the naked eye. Calculating in the same

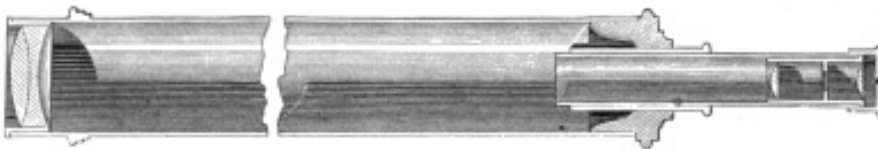

Achromatic Telescope (in Section)

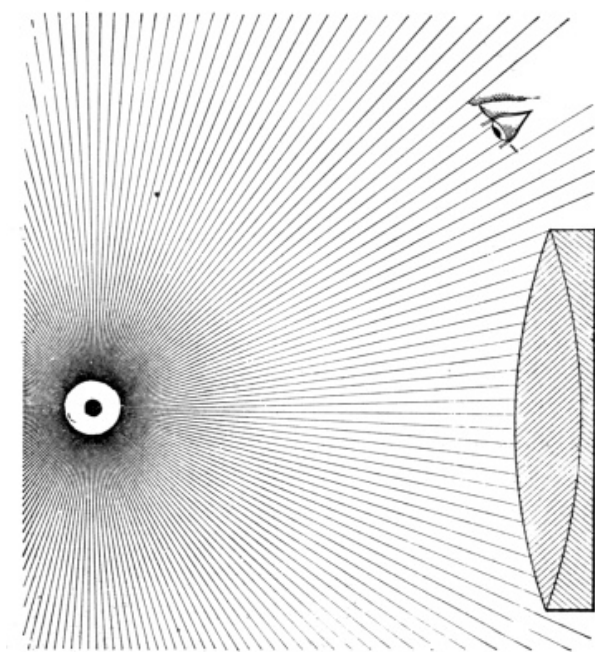

Eye and Objective collect Rays to Proportion to their Areas

way the efficiency of the great 40-inch lens of the Yerkes Observatory, it is found to be 40,000 times that of the eye. Test light-gathering power by ascertaining the faintest stars visible in the telescope, and comparing with lists of suitable objects. (b) The defining power of an objective is partly its ability to show fine details of the moon and planets perfectly sharp and clear; but more precisely it is the power of separating the component members of close double stars (page 392). This power varies directly with the size or diameter of object glasses, if they are perfect; that is a 6-inch glass will divide a double star whose components are $0''.8$ apart, whereas it will re-

quire a 12-inch glass to separate a double star of only $0''.4$ distance. But defining power is quite as dependent upon perfection of the original disks of glass, as upon the skill and patience of the optician who has ground and polished them. A large defect of either makes a worthless telescope.

Method of Testing a Telescope.—Unscrew the cell of the objective from the tube, but do not take the lenses out of the cell. If on looking through it at the sky, the glass appears clear and colorless, or nearly so, the light-gathering power may be regarded as satisfactory. Small specks and air bubbles will never be numerous enough to be harmful; each only obstructs a small pencil of light equal to its area. The defining power may be tested in a variety of ways. Following is the method by an artificial star: Point the telescope on the bulb of an ordinary thermometer which lies in the sunshine, 50 feet or more distant. Or the convex bottom of a broken bottle of dark glass may be used, *R* in the illustration. On focusing, an artificial star will appear, due to reflection of the sun from the bulb, sometimes surrounded by diffraction rings (*A*, Figure 9.13). Slide eyepiece inward and outward from focus, until bright point of light spreads out into a round luminous disk, *B*. This is called the spectral image. A dark center, when the eyepiece is pulled out, and a brighter central area when pushed in, show that curvature of the glasses is more or less imperfect. A spectral image having a piece cut out, or a brush of scattering light, is a sign of bad defects inherent in

the glass itself. An excellent objective gives spectral images perfectly circular, and evenly illuminated throughout, *B*. Repeat these tests on stars of the first magnitude. Heat from a lighted lamp placed where shown will simulate many deleterious effects of a very unsteady atmosphere. *A* and *B* then become *C* and *D*, rays and spots of the latter being continually in motion.

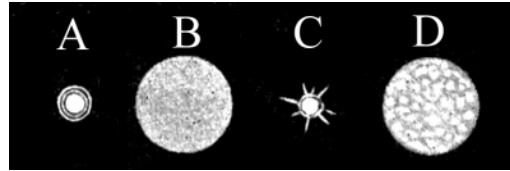

Spectral Images

A Small but Useful Telescope.—By expending a few cents for lenses, a person of average mechanical ability may, by a few hours' work, become possessed of a telescope powerful enough to show many mountains on the moon, spots on the sun, satellites of Jupiter, and a few of the wider double stars. Buy from an optician two spectacle lenses, round rather than oval, and of very different powers; for instance, No. 5 and No. 30. These numbers express the focal lengths of the lenses. Fit together two pasteboard tubes so that one will slide inside the other quite smoothly. Their combined length must be about six inches greater than the sum of the numbers of the two lenses. Blacken the inside of tubes, and attach the lenses to their outside ends. No. 30 being the objective, and pointed toward the object, the magnifying power of the two lenses, when separated by a distance equal to the sum of their focal lengths, will be equal to their ratio, or six diameters. It was with a telescope made in this way that the writer, when a boy of fourteen, got his first glimpse of the satellites of Jupiter. A few dollars will buy a good achromatic object glass (of perhaps two inches diameter) and a pair

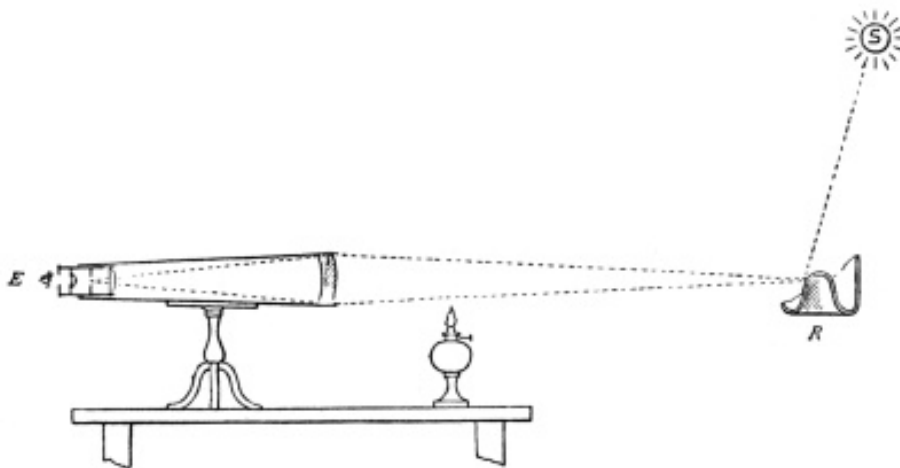

One Method of Testing a Telescope

of suitable eyepieces (powers about 25 and 100). A suitable mounting for such telescopes has already been described on page 44. The most important optical requisite is stated on page 171.

The Great Refractors.—The largest is M. Gautier's 50-inch horizontal telescope at Paris, 186 feet long. A moving mirror reflects the light into it. Next comes the 40-inch telescope, 65 feet long, of the Yerkes Observatory (pages 7 and 15). More favorably located is its rival in size, the famous Lick telescope of 36 inches aperture, situated on the summit of Mount Hamilton, California, 4300 feet above the sea.

The mountings or machinery for both these great instruments were built in Cleveland, by Messrs. Warner & Swasey; but the object glasses were made by the celebrated firm of Alvan Clark & Sons, of Cambridgeport, from glass disks manufactured in Paris. No optical glass of the highest quality has yet been made in America, the process being, in some essentials, secret. Steinheil of Munich completed in 1900 an objective of $31\frac{1}{2}$ inches aperture, of the new glass, for the astrophysical observatory near Berlin. A glass of like dimension by Henry is at the Meudon Observatory, Paris. The Clarks have made also an objective of 30 inches aperture, mounted by Repsold, at the Russian Observatory of Pulkowa, near Saint Petersburg. A glass of equal size, figured by the Brothers Henry of Paris, is mounted at the splendid observatory founded by Bischoffsheim at Nice, in the south of France. A 29 inch by Martin is at the Paris Observatory. The next three telescopes were made at Dublin, by Sir Howard Grubb, one of 28 inches and one of 26 inches aperture, located at the Royal Observatory, Greenwich, and the other, of 27 inches, at Vienna. Following these in order are a pair of telescopes of 26 inches aperture, made by Alvan Clark & Sons, one of which is the principal instrument of the United States Naval Observatory, at Washington, and the other is located at the University of Virginia. Between the dimensions of 25 inches and 15 inches there are about two dozen refracting telescopes in all, many of which were made by Alvan Clark & Sons, although Brashear of Alleghany, an optician of the first rank, has made an 18-inch glass, now at the University of Pennsylvania. Quite the opposite of reflectors, it is noteworthy that most of the great refractors have been built in America; and that they have contributed in a more marked degree to the progress of astronomical science.

Invention and Growth of the Reflecting Telescope.—If converging the rays of light by refraction could never make a perfect telescope, clearly the only method left was to gather them at a focus by reflection from a highly polished surface. Although this way of making a telescope seems to have been understood as early as 1639, still a quarter century elapsed before Gregory built the first one (1663). He used two concave mirrors as in the illustration; the one large to form the image, and the other small to reflect the rays out of the tube to the eyepiece. Ten years later Cassegrain made a farther improvement, replacing the small concave mirror of Gregory by a convex one (shown in the illustration

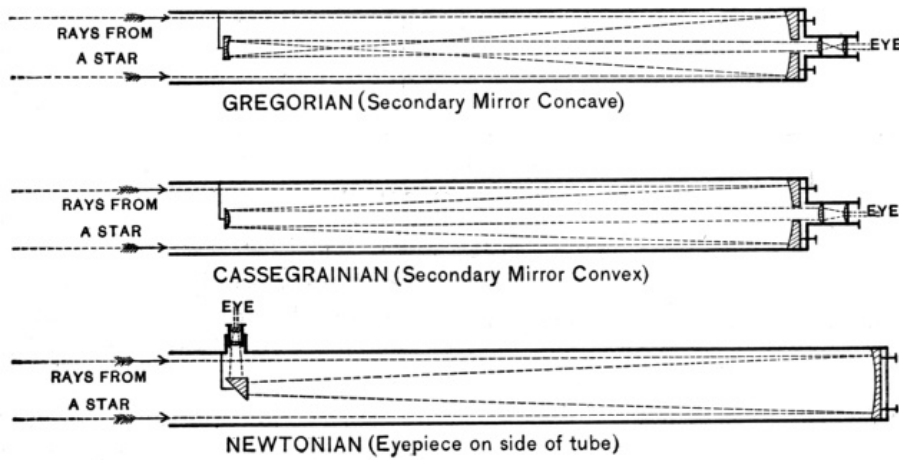

Three Types of Reflecting Telescope

also). Both these forms of reflector have the advantage that the observer looks directly toward the object at which the telescope is pointed; but there is a great disadvantage in that the center or best part of the mirror has to be cut away, in order to let the rays through it to the eyepiece. The mirror is left whole, and less of its light is sacrificed in the form invented by Newton (1672), who interposed a small flat mirror, at an angle of 45° with the axis of the larger mirror. This arrangement, most commonly used in reflecting telescopes at the present day, has a slight disadvantage in that the observer must look into the eyepiece at right angles to the direction of the object under examination (see figure); but a small right-angled or totally reflecting prism is now universally employed in lieu of the little diagonal mirror, thereby saving a large percentage of light. A fourth form of reflector, first suggested by Le Maire, was used by Herschel, in the latter part of the 18th century; he tilted the speculum slightly, to bring its focus at the side of the tube. Tilting the mirror saves all the light, but distortion of the image is not easy to avoid. Recently, for the purpose of reducing this distortion, an instrument called the 'oblique Cassegrain' has been brought out in England; also in Germany the 'brachy-telescope,' or short telescope, has been invented to overcome this difficulty, by second reflection from a small and oppositely inclined convex mirror. Down to the middle of the 19th century, specula were always made of an alloy, generally composed of 59 parts of tin and 126 of copper. Specula are now almost universally made of glass, with a very thin film of silver deposited chemically upon the front surface, not upon the back as in the common mirror. These telescopes are often called silver-on-glass reflectors. As the light does not pass through the glass, it may be much inferior in quality to that required for a lens. Because less difficult to build, the great telescope of the future will probably be a reflector, although of inferior definition. Great refractors are, however, less

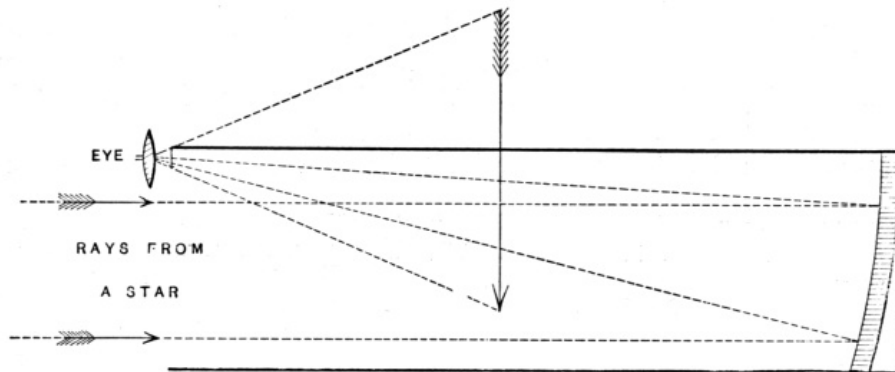

Le Mairean or Herschelian Reflecting Telescope

clumsy and more effective for actual use.

The Great Reflecting Telescopes.—The largest, sometimes called the ‘leviathan,’ was built by the late Lord Rosse in 1845 at Birr Castle, Parsonstown, Ireland. The speculum is of metal, six feet in diameter, and about eight inches thick. Its excessive weight of four tons makes a very heavy mounting necessary.

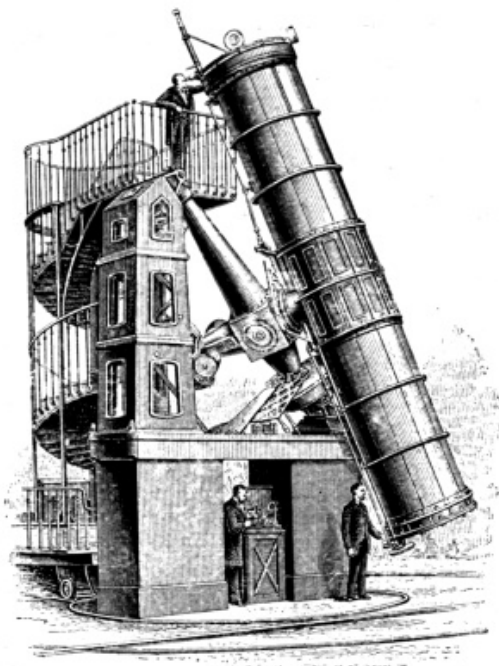

The Great Paris Reflector (Martin)

Lord Rosse’s telescope is Newtonian in form. The giant tube is 56 feet long, and 7 feet in diameter. The next in size is a five-foot silver-on-glass reflector, built by Common in 1889 at Ealing, England. This powerful telescope was remounted at Harvard College Observatory in 1904–1906, with many novel conveniences for facilitating its use. The Carnegie Solar Observatory, Mount Wilson, California, possesses a reflector of equal size. In 1867 Thomas Grubb built a four-foot silver-on-glass ‘Gregorian’ for the observatory at Melbourne, Australia, and it is one of the most convenient in use of all the great reflectors. In the latter part of the 18th century Sir William Herschel built numerous reflecting telescopes, among them one of four feet diameter, and another of half that size; he made many important discoveries with them, but none are now in condition to

use. Lassell, an eminent English astronomer, built two great reflectors, one of

four feet, and the other of two feet aperture, which he used on the island of Malta, 1852–1865. Several reflectors, three feet aperture, have been constructed, the most important of which is owned by the present Lord Rosse; also one by the Lick Observatory. At the Paris Observatory is a great silver-on-glass reflector of nearly four feet aperture, which Deslandres employed effectively in finding motions of stars toward or from the earth. It is interesting to note that few of these great instruments have been constructed in America. One of the largest reflectors ever built in the United States is 28 inches in diameter. It was made by Henry Draper, New York, in 1871, and is now at the Harvard Observatory. Among present builders of reflecting telescopes in America are Edgecomb of Mystic, Connecticut; and Brashear, one of whose lesser instruments is pictured in the adjoining illustration.

Reflectors and Refractors compared.—In reflectors of medium size, tarnish and deterioration of the polished surface are the chief disadvantage. But the film of a mirror less than a foot in diameter is readily renewed. When freshly silvered, a 12-inch speculum will collect the same amount of light as a 12-inch object glass, loss by reflection from the former being about equal to loss by absorption in passing through the latter. Well figured and newly polished mirrors of no greater dimension than this usually perform excellently; and there is a marked advantage from the gathering of rays of all colors at the same focus. But from 12 inches upward, flexure of the mirror begins to cause difficulties which increase rapidly with the size of the speculum. The mirror may be given a perfect parabolic figure for the position in which it is polished; but as soon as turned to another angle of elevation, gravity distorts its figure. As a result, rays from a star are not collected at a single point, but scattered round it. The larger the mirror, the greater this difficulty, becoming almost impossible to alleviate entirely. Glass mirrors, in order to be least affected by it, should have a thickness equal to one sixth of their diameter. With object glasses, on the other hand, bending of the lens by its own weight in different positions has not been found to affect appreciably the character of images formed by any of the great glasses, except the 40-inch, which suffers a slight deformation of images in certain positions. Still, it must be remembered that the objective, although called achromatic, is not completely so; and in some of the very large refractors, the intense blue light surrounding a bright object is

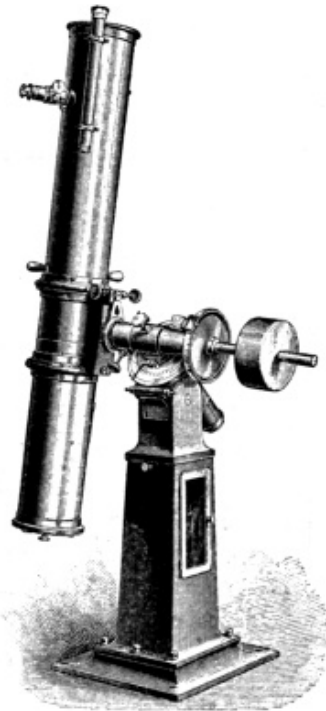

A Modern 'Newtonian' by
Brashear

often a serious obstacle in the work of practical observation. On the whole, the refractor is generally preferred to the reflector. It is easier to adjust and keep in order; and its tube being closed, it is much less subject to harmful effect of local air currents. It is a fact, too, that more than three fourths of all the work of astronomical observation has been done with refracting telescopes.

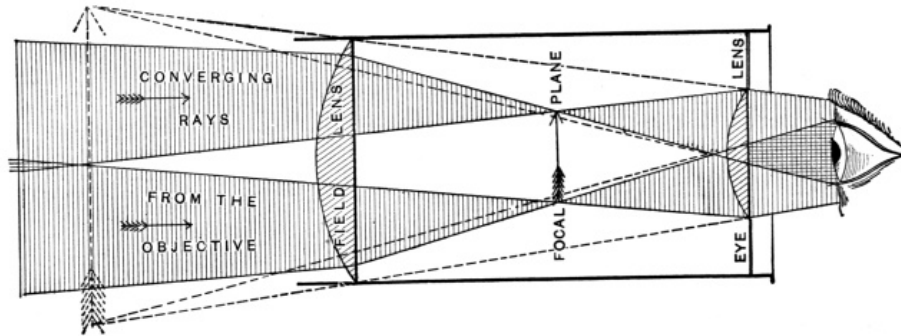

Path of Rays through a Negative (Huygenian) Eyepiece

The Eyepiece.—The eyepiece of a telescope is simply a magnifying glass, or microscope for examining the image of an object formed at the focus by the objective. Any small, convex lens, then, may be used as an eyepiece, but its effective field of view is very limited. So a combination of two plano-convex lenses is usually employed, in order that the field may be enlarged, and vision be distinct everywhere in that field. Two forms of celestial eyepiece are common, called the *negative* and the *positive* eyepiece. Both forms have a smaller, or eye lens, and a larger, or field lens; the latter toward the objective, the former nearer the eye. In the negative (sometimes called from Huygens, its inventor, the Huygenian) eyepiece, both eye lens and field lens have their flat faces turned toward the eye, as in the preceding figure. In the positive (called, also, from

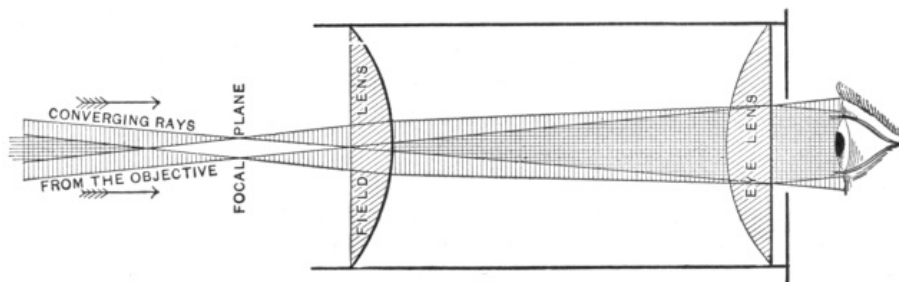

Path of Rays through a Positive (Ramsden) Eyepiece

its inventor the Ramsden) eyepiece, the convex faces of both lenses are turned

inward, or toward each other, as in the above figure, where the eye lens is drawn double its proper diameter. The negative eyepiece has its focus between the two lenses. The focus of the positive eyepiece lies beyond both lenses, a short distance toward the objective. Positive eyepieces are always used for transit instruments and micrometers. Both these forms of eyepiece do not themselves invert, but when employed in conjunction with an object glass, they show all objects inverted, the objective itself causing the inversion, because the rays cross

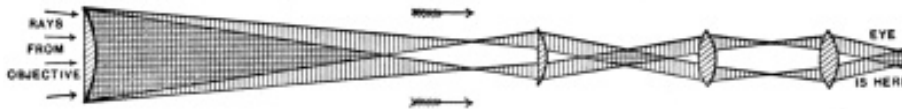

Path of Rays through a Terrestrial or Erecting Eyepiece

in passing through it. A terrestrial or day eyepiece is one which, when employed with an object glass, shows all objects right side up. The re-inversion of the image necessary to effect this is produced, as shown in the preceding illustration, by constructing the eyepiece of four lenses instead of two. Different eyepieces of different magnifying powers may generally be used with the same objective, by means of suitable draw-tubes, called *adapters*. The same eyepiece can be used in either reflectors or refractors.

To ascertain the Magnifying Power.—Following is an easy method: Select a convenient object marked with dividing lines at pretty regular intervals—clapboards on a house, bricks in a wall, or better the joints where plates of tin are lapped on a roof. When the sun is shining obliquely across them, set up the telescope as distant as possible, yet near enough so that the joints can readily be counted with the naked eye. Then point the telescope at the roof. Look at it through the eyepiece with one eye, and with the other look along the outside of the telescope at the roof also; first with one eye, then with the other, then with both together. Amplification, or magnifying power (at that distance of the telescope from the roof) is equal to the degree of this enlargement; and it can be ascertained by simply counting the number of divisions (as seen by the naked eye) which are embraced between any two adjacent joints as seen in the telescope. The two images of the same object will be seen superposed, and a little practice will enable one to make the count with all necessary accuracy. Good telescopes are usually provided with an assortment of eyepieces whose magnifying powers range approximately between seven and 70 for each inch of aperture of the object glass. For example, a four-inch telescope would have perhaps four eyepieces, magnifying about 25, 90, 200, and 300 times.

How to measure Small Angles.—The micrometers is an instrument for measuring small angles. It is attached to the telescope in place of the eyepiece. The illustration shows all the important working parts. Crossing the oblong field of view are seen two spider lines (*aa*), with which the measuring is done. All parts

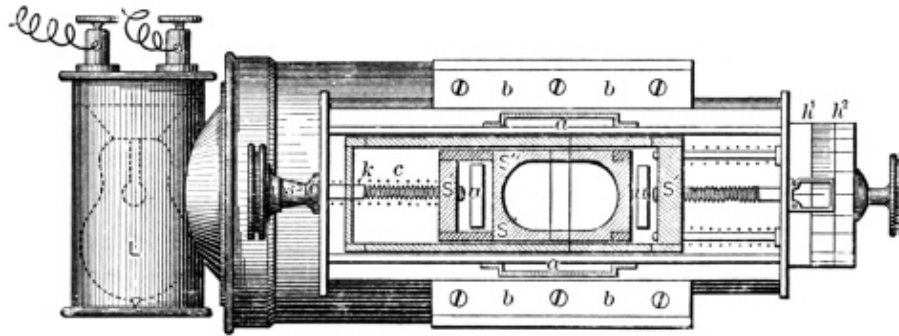

A Modern Micrometer with Electric Illumination (Ellery)

of the micrometer are so devised and related that these two lines can be seen at night in the dark field of view; moved with accuracy slowly toward or from each other; and their exact position recorded. In the best modern micrometers, either the lines or the field of view can be illuminated at will by a small incandescent electric lamp (*L*). The spider lines are attached to separate sliding frames; each frame can be moved by a thumbscrew, the head of which projects outside the micrometer box. One of these, called the micrometer screw, has enlarged heads ($h^1 h^2$) graduated to show the number of turns and fraction of a turn of this screw. The eyepiece (not shown) is a positive one attached to the micrometer box in front of the sliding frames. To measure a small arc,—for example, the diameter of a planet—point the telescope so that the disk of the planet appears in the center of the field of view. Then turn the two thumbscrews until the spider lines are both seen tangent to opposite sides of the disk at the same time. Read the micrometer-head. Then turn the micrometer-screw, until the two lines appear as one. Read the head again; take the difference of readings, and multiply it by the arc-value of one turn (which must have been previously determined). Resulting is the diameter of the planet in arc.

The Transit Instrument.—Soon after the invention of the telescope, early in the 17th century, an instrument was devised by a Danish astronomer, Roemer, which has now supplanted nearly every other for determining time with precision. It is called the transit instrument, because used in observing the passage, or transit, of heavenly bodies across the field of view. Ordinarily it is mounted in a north and south line. On top of the two rigid triangular piers (on the next page) are bearings in which the axis of the transit instrument turns. The telescope *F* is secured at right angles to the axis *C*. When turned round in its bearings, the telescope describes the plane of the meridian. On that account it is sometimes called a

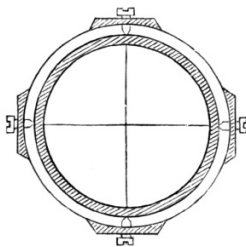

Adjustable Reticle

describes the plane of the meridian. On that account it is sometimes called a

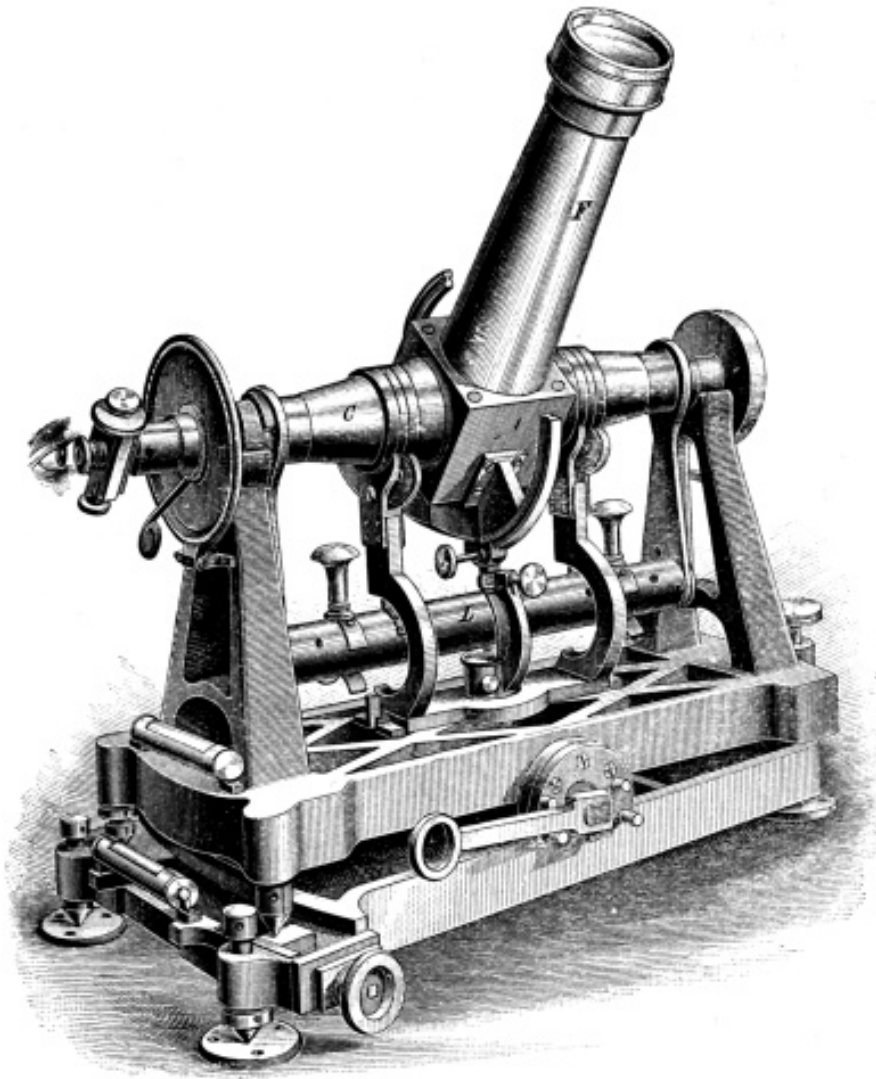

A Compact Modern Transit Instrument (from a Design by Heyde)

meridian transit. In the convenient type of transit here pictured, the axis forms half of the telescope tube. A glass prism in the central cube reflects the rays through *C* to the eye at the left. Such an instrument is often called a 'broken transit.' Until the instrument is reversed, the eye remains stationary, no matter what the declination of the star observed.

Observing with the Transit Instrument.—First, it must be adjusted. A level, *L*, hanging below, makes the axis horizontal. In the field of view is a reticle, often made of spider lines, but sometimes by ruling very fine lines with a diamond point on a thin plate of optical glass. The reticle is accurately adjusted

in focal plane of object glass, and in smaller instruments, surveyor's transits, for example, lines are arranged as in the two illustrations above. The lines are often called threads or wires. The *line of collimation* is the line from the center of object glass to the central intersection of lines of reticle. This line is adjusted perpendicular to the axis of revolution of the telescope.

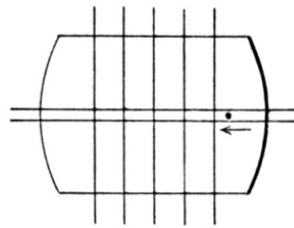

Reticle of Transit

Then by repeated trials upon stars, the Y's, or bearings, are shifted very slightly north or south, on pivots (page 185) under the left-hand end of the base, until the axis lies precisely east and west. When the foregoing adjustments have been made, the telescope, or more accurately the line of collimation, swings round in the true plane of the meridian. To observe a star, count the beats of the clock while looking in the field of view; and set down the second and tenth of its crossing the central vertical line of the reticle. In the illustration a star is seen approaching the vertical or transit lines. If a very accurate value is desired, observe the passage over the five central lines, and then take the average. This will be the time required.

The Astronomical Clock.—

Timepieces used in observatories are of two kinds, clocks and chronometers. One or the other is indispensable. The astronomical clock has a pendulum oscillating once each second: if it oscillates once a sidereal second, it is a sidereal clock; if once a mean solar second, it is a mean time clock. A seconds hand records each oscillation. Also it has hour and minute hands, like ordinary clocks, except that the dial is usually divided into 24 hours instead of 12, for the convenience of the astronomer, in recording hours of the astronomical day, or in following the stars according to right ascension. If, at any instant, the clock does not show

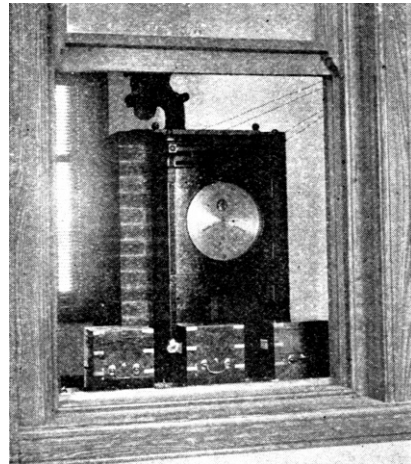

View into Clock-room (Lick Observatory)

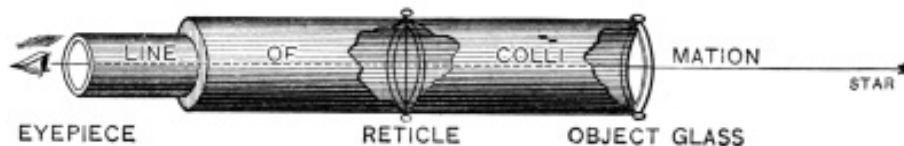

To show the Line of Collimation

exact time, the difference between true time and clock time is called the correction, or error of the clock. This must be found from day to day, or from night to night, by observing transits of the heavenly bodies with the meridian circle or the transit instrument. If a clock does not keep exact pace with the objects of the sky, it is said to have a rate. As with the chronometer, daily rate is the amount by which the error changes in 24 hours. A large rate is inconvenient, but does not necessarily imply a bad clock. The less the rate changes the better the clock. Dampness of the air and sudden changes of temperature are hostile to the fine performance of timekeepers of every sort. Equality of surrounding conditions is secured as much as possible by keeping clocks and chronometers, as the last illustration shows, in a small and separate room, where the air may readily be kept dry and its temperature nearly constant.

Pendulum and Escapement.—Horology is the science which embraces everything pertaining to measurement of time, and to mechanical contrivances for effecting this end. The

chronometer is described and pictured in the preceding chapter (page 148). Accurate running of a clock is dependent mainly upon two parts of its mechanism, (a) the pendulum, and (b) the escapement. The pendulums of all observatory and standard clocks are compensated for temperature, so that the natural fluctuations of this element may have little or no effect upon the length of the pendulum, and therefore upon its period of oscillation. There is a variety of methods by which the compensation is effected. The illustration shows the simplest of them. The steel pendulum rod passes through a zinc tube (shaded), to the bottom of which is attached the heavy pendulum-bob. With a rise of



Compensation Pendulum

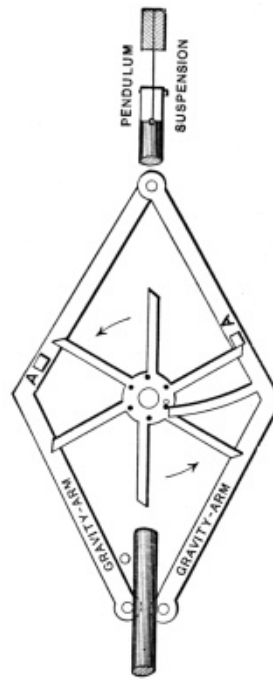

Gravity Escapement

temperature, the downward expansion of the steel is just equalized by the upward expansion of the zinc; so the center of oscillation remains at the same distance from the point of support. The center of oscillation is that point of a pendulum in which, if the whole mass of the pendulum were concentrated, the period of

oscillation would not vary. The gridiron pendulum and the mercurial pendulum are other forms of compensation. Next in importance to the pendulum is the escapement. The illustration represents in outline one of the best forms. It is called the gravity escapement, because the pendulum is driven by the pressure alternately of two gravity arms, which are swung aside by the six black pins in the hub of the escapement wheel. The clock train does the work of raising the arms outward from the pendulum rod; so that the pendulum swings almost perfectly free, having no work to do except to raise the gravity arms just enough to trip the escapement at the smoothly polished jewels *AA*.

The Chronograph.—In recording transits of the heavenly bodies, greater convenience, rapidity, and precision are attained by using the chronograph, a mechanical contrivance first devised by American astronomers about 1850, and now used in observatories universally. The illustration (on the facing page) shows an excellent type of this instrument. The chronograph consists of a cylinder about 8 inches in diameter and 16 inches in length, which revolves once every minute at a

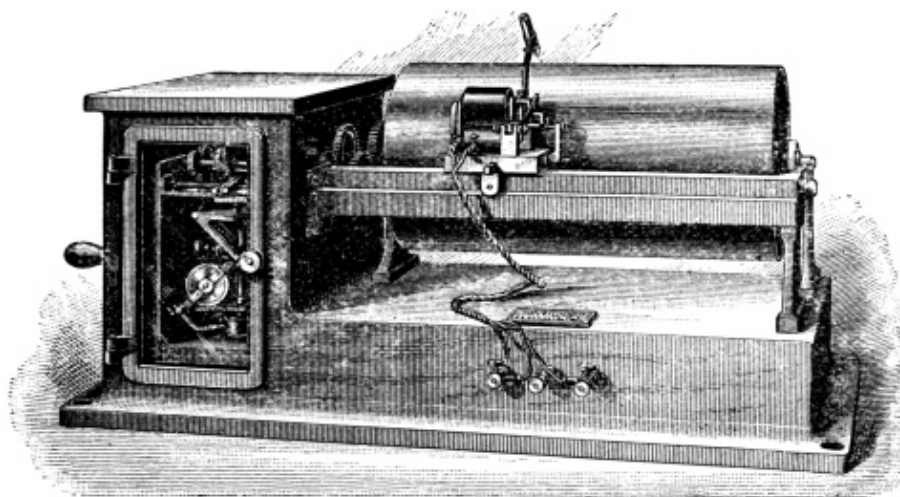

A Modern Chronograph by Warner & Swasey

uniform speed. Wound upon it is a sheet of blank paper, and above it trails a pen connected with an armature, so that every vibration of the pendulum, by closing an electric circuit, joggles the pen or throws it aside a fraction of an inch at the beginning of each second. The illustration shows a small part of a chronograph sheet, full size. As the barrel or cylinder revolves, the pen carriage travels slowly along, so that the trail of the pen is a continuous spiral round the barrel, with 60 notches or breaks in every revolution. In the circuit of the pen armature is a small push button, called an observing key. This is held in the hand of the observer while the star is passing the field. Whenever it crosses a spider line, a tap of the observing key records the instant automatically on the chronograph paper,

which may be removed and read at leisure. As is apparent from the illustration, tenths of a second are readily estimated, even without any measuring scale. The breaks at regular intervals are made automatically by the timepiece. The short breaks between *A* and *B* are made in quick succession by the observer, to show that a star is just coming to the lines. Transit of the star over the first two lines took place at *C* (7 h. 16 m. 7.4 s.), and at *D* (7 h. 16 m. 11.4 s.), reading in all cases from the preceding (or lower) side of the break. By transits of ten stars of five lines each, a good observer can determine the error of his timepiece within two or three hundredths of a second. Hough has recently perfected a printing chronograph which records the time in figures on a paper fillet.

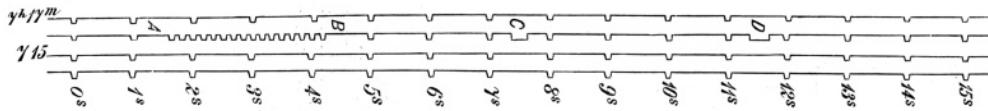

Part of the Chronograph Sheet

Personal Equation.—Few observers, no matter how practiced, tap the key exactly when a star is crossing a line. Most of them make the record just after the star has crossed, and still others always press the button a small fraction of a second before the star reaches the wire. It does not matter how much too early or too late the record is made, because the difference can usually be found by methods known to the practical astronomer; but a good observer is one who makes this difference invariable; that is, his personal equation should be a constant quantity. The personal equation of an observer is the difference between his record of any phenomenon, and the thing itself. In observing transits of heavenly bodies, most observers have a personal equation amounting to one or two tenths of a second of time. Personal equation is usually found by observing with a personal equation machine, an instrument which records on a single chronograph sheet, not only the observer's time of transit, but also the absolute instant when the star is crossing the lines. Figure 9.31 shows such a machine. Light from the lamp on the right provides an artificial star which the clockwork makes to travel across the lines in front of the observing tube on the left. Absolute time is time corrected for personal equation. It is nearly always required in the accurate determination of longitudes by the electric telegraph.

The Photo-chronograph.—As the effect of personality is usually absent from all records made by photography, many attempts have been made to register star-transits by photographic means. The instrument which does this takes the place of both eyepiece and chronograph, and is called the photo-chronograph. Opposite is a picture of this ingenious little instrument. If a photographic plate is firmly fixed in the focal plane of a transit instrument, and a star is allowed to move through the field, the negative will show a fine, dark line or trail, crossing

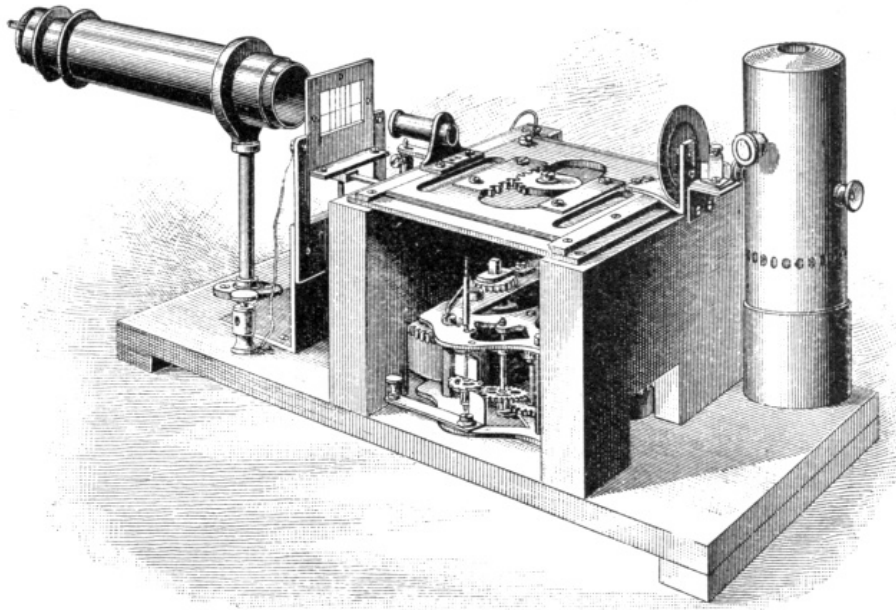

Machine for determining Personal Equation (Eastman)

the plate horizontally from west to east. By holding a lantern in front of the object glass a few seconds, the vertical lines in the field may also be obtained on

the same plate. There will be, then, an absolute record of the star's path through the field and across the lines; but nothing will be known as to the time when the star was crossing any particular line. Now instead of fastening the plate, insert it in a little frame which slides north and south a small fraction of an inch. So arrange the details of the mechanism that an armature will move the frame automatically. Connect this armature into a suitable clock circuit, in place of the

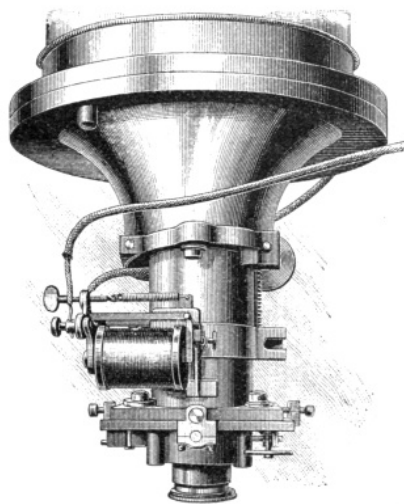

The Photo-chronograph (Fargis-Saegmüller)
 ordinary chronograph pen. Instead of a star transit, or ordinary, horizontal trail like this—

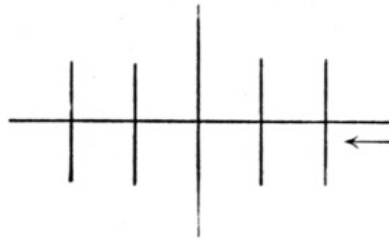

Ordinary Star Trail

the plate when developed will show this—

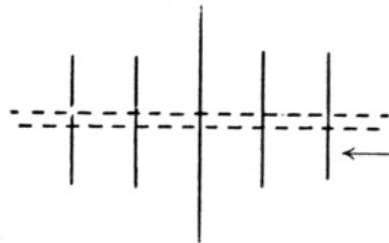

Interrupted Star Trail

It is easy to find the particular second corresponding to each one of the little broken trails on the plate, and by using a magnifying glass the fractional parts of seconds where the reticle lines cross the trails can be measured with accuracy and with almost no effect of personal equation. In another form of photo-chronograph, the plate is stationary, and the armature actuates an occulting bar, which screens the plate except for an instant, once every three seconds. The star trail is then reduced to a series of equidistant dots.

The Meridian Circle.—The meridian circle is an instrument for measuring right ascensions and declinations of heavenly bodies. Its foundations are two piers or pillars, in an east and west line. On top of each is a **Y** or bearing, and in these turn two pivots, accurately fashioned, cylindrical in form. On top of them rests an accurate striding level. The pivots are attached solidly to the massive axis proper, this latter being made up of two cylinders, or inverted cones, and a central cube between them, through which passes the telescope, rigidly fastened perpendicular to axis. On either side of the telescope, a finely divided circle is secured at right angles to the axis. Circles, axis, telescope, and pivots, then, all revolve round in the **Y**'s together, as one solid piece. The delicate bearings are in part relieved of this great weight by means of counterpoises. Firmly attached to the right pier are microscopes for reading with high accuracy the graduation on the rim of the circle. The zero point of the circle is usually found by placing

a basin of mercury underneath the telescope, which is then pointed downward upon the mercury. When the horizontal lines in the field of view are seen to correspond exactly with their images reflected from the mercury, the position of the circle is read from the microscopes; and this is the zero point, because the line of sight through the telescope is then vertical. The operation of obtaining this zero point is called 'taking a nadir.'

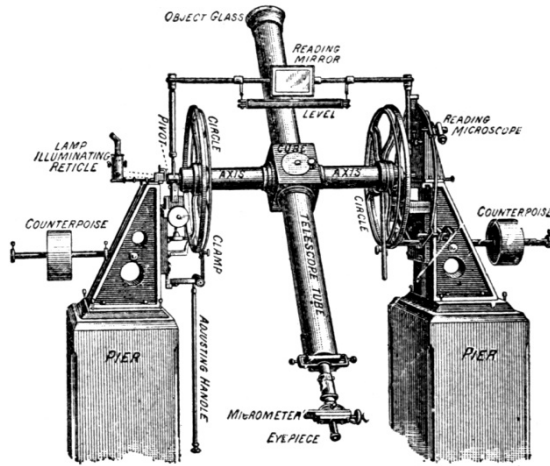

Meridian Circle (from a Design by Landreth)

Combining it with the latitude of the place gives the circle reading for pole or equator, and so any star's declination may be found. The meridian circle is often called also the

transit circle. Right ascensions are observed with the meridian circle exactly as with the transit instrument previously described.

The Equatorial Coudé.—A very advantageous and convenient combination of refractor and reflector is the **T-shaped** or 'elbow telescope,' called the equatorial coudé. It was invented by Loewy, the present director of the Paris Observatory, and is a type of instrument well known in the observatories of France, although there are as yet none in the United States.

The chief advantage is that the instrument itself, as shown in the illustration, is nearly all in open air, while the observer sits in a fixed position, as if working at a microscope on a table. The eyepiece, therefore, is in a room which may be kept at comfortable temperatures in winter. The instru-

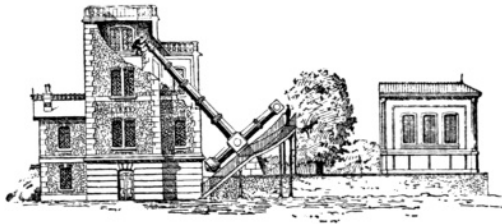

The Equatorial Coudé (Loewy)

ment can be handled easily and rapidly, and is very convenient for the attachment of spectroscopes and cameras. The splendid lunar photographs on pages 14 and 220 were taken with this telescope. Its chief disadvantage is loss of light by reflection from two plane mirrors, set at an angle of 45° in two cubes shown at the lower end of the polar axis. The object glass is mounted in one side of the right-hand cube, near the attendant. This cube with its mirror and objective

turns round on an axis in line with the central cube, and forming the declination axis. Beneath the central cube is the lower pivot of the polar axis. The long oblique telescope tube is itself the polar axis, and its upper bearing is near the eyepiece. A powerful clock carries the whole instrument round to follow the stars, and the upper cube is counterpoised by a massive round weight at the lower end of the declination axis. First cost of the equatorial coudé is about double that of the usual type of equatorially mounted telescope; but the large expense for a dome is mostly saved, as the coudé is housed under a light structure which rolls off on rails to the position shown in the engraving.

Common Mistakes about Telescopes.—Perhaps the question most often asked the astronomer by persons uninformed is, How far can you see with your telescope? Evidently no satisfactory answer can be given, for all depends upon what one wants to see. If terrestrial distance is meant, the large telescope does not possess an advantage proportionate to its size. All objects on the earth must be observed through lower strata of the atmosphere, and these regions are so much disturbed in the daytime by intermingling of air currents, warm and cold, that the high magnifying powers of large telescopes cannot be advantageously used. If celestial distance is meant by the question, How far? the answer can only be inconclusive, because the telescope enables us to see as far as starlight can travel. The brighter the star, the greater distance it can be seen, independently of the telescope. The smallest glass will show stars so far away that light requires hundreds of years to reach us from them. The larger the telescope, the fainter the star it will show; but it is not known whether these fainter stars are fainter because of their greater distance or simply because they are smaller or less luminous. Another common question is, How much does your telescope magnify? as if it had but one eyepiece. Actually it will have several, for use according to the condition of the atmosphere and the character of the object. A more intelligent question would be, What is the highest magnifying power? This will never exceed 100 diameters to each inch of aperture of the objective, and 70 to the inch is an average maximum. Even this, however, is high, if advantageous magnifying power is meant. So unsteady is the atmosphere in the eastern half of the United States that magnifying powers exceeding 50 to the inch cannot often be used to advantage in observing the planets.

Celestial Photography.—As soon as Daguerre, in 1839, had invented photography, it was at once seen that the brighter heavenly bodies might be photographed, because telescopes are used to form images of them in exactly the same way that the camera produces an image of a person, a building, or a landscape. Photography is simply a process of fixing the image. In 1840 the moon was first photographed, in 1850 a star, in 1854 a solar eclipse, in 1872 the spectrum of a star, in 1880 a nebula, in 1881 a comet, in 1897 the spectrum of a meteor, and in 1898 a stellar occultation by the moon. All these photographs were first made in America. Continued improvement in processes of photography makes it possible to take pictures of fainter and fainter celestial bodies, and the larger

telescopes have photographed exceedingly faint stars which the human eye has never seen—perhaps never can see. This is done by exposing the sensitive plate for many hours to the light of such bodies; for, while in about 10 seconds the human eye, by intense looking, becomes weary, the action of faint rays of light upon the photographic plate is cumulative, so that the result of several hours' exposure is rendered readily visible when the plate is developed. In this way, an extra sensitive dry plate, of the sort most generally employed, will often record many thousand telescopic stars in a region of sky where the naked eye can see but one (page 398). Nearly every branch of astronomical research has been advanced by the aid of photography, so universal are its applications to astronomy.

How to take Photographs of the Heavenly Bodies.—Any good telescope or camera may be satisfactorily used in taking photographs of celestial objects. Remove the eyepiece, and substitute in its place a small, light-tight plate-holder. Fasten it to the tube temporarily, so that the plate will be in the focus of the object glass. This point may be found by moving forth and back a piece of greased or paraffin paper, until the image of the moon is seen sharply defined. Adjust plate-holder and finder so that when an object is in the field of the finder, it will also be on the center of the plate. Insert a plate in this position, and make an exposure of about half a second on the moon, if within two or three days of the 'quarter.' The object glass should be covered by a cap or diaphragm having about three fifths the full aperture of the lens. On developing, the moon's image will be somewhat blurred. In part this is because the best focus for photographing is either outside or inside the visual focus, found by the greased paper. To find the best focus, move the plate-holder farther from the lens, first $\frac{1}{4}$ inch, then $\frac{1}{2}$ inch, then $\frac{3}{4}$ inch, then 1 inch, making at each point an exposure of the same length as before. Compare the negatives. The true photographic focus lies nearest the point where the best-defined picture was taken. If desired, the process may be repeated near this point, shifting the plate only a few hundredths of an inch each time. If the pictures are more and more blurred the farther the plate is moved from the lens, the focus for photography may be inside the visual focus first found, and the plate-holder should then be moved in accordingly, making trials at different points. When the photographic focus is finally found, the plate-holder should be securely fastened to the eyepiece tube, or adapter; and a mark made so that it may readily be adjusted to the same spot whenever needed in the future. A meniscus of suitable curvature is sometimes attached in front of the object glass, to focus the photographic rays (about $\frac{1}{7}$ nearer the objective). Also E. C. Pickering has found that an achromatic objective with crown lens properly figured can be converted into a photographic telescope by reversal of the crown lens. In achromatic objectives of the new Jena glass, visual and photographic foci are practically coincident. Ritchey and others have secured excellent photographic results with visual refractors by inserting a yellow screen close in front of the sensitive plate (isochromatic) and lengthening the exposure accordingly.

Astronomical Discoveries made by Photography.—The great benefit to astronomy from the application of photography in making discoveries was first realized when, during the total eclipse of 1882 in Egypt, the photographic plate discerned a comet close to the sun (page 267). But interest was intensified when a hazy mass of light was seen to surround the star Maia of the Pleiades, on a plate exposed for about an hour to that group of stars in November, 1885. This astronomical discovery by means of photography was soon after verified by the 30-inch telescope at Pulkowa, Russia. Many other nebulæ, both large and small, have since been discovered by photography, some of which have been verified by the eye. By photographing spectra of stars, peculiarities of constitution have been immediately revealed which the eye had long failed to discover directly (page 386). Several new double stars have been found in this way, and important discoveries as to classification of stars have been made from critical study of stellar spectrum photographs (page 386). Long exposures of comets have brought to light certain details of structure which the eye has failed to detect (page 355). In discovering minor planets, photography has, since 1890, been of constant assistance because of ease and accuracy in mapping fixed stars in the neighborhood of these minute objects. It is about 20 times easier to find a small planet on a photographic plate than by the former method of mapping the sky optically. But discoveries in solar physics by means of photography are most important of all, for it has been found that the faculæ, or white spots, extend all the way across the sun's disk in about the same zones that spots do (page 238); and complete photographic records of the sun's chromosphere and prominences are now made every day by means of radiations to which photographic plates are very sensitive, but which our eyes unaided are powerless to see. Lunar photographs, too, are thought by some astronomers to have revealed minute details which the eye has failed to detect. Also the new satellites of Jupiter and Saturn (pp. 304, 306) were first discovered, and their orbits found, by photography.

We now turn to a consideration of present knowledge of our satellite, and of the other and more remote orbs of heaven, as disclosed by the instruments of which we have just learned.

Chapter X

The Moon

The moon was the subject of the most ancient astronomical observations, for elementary study of her motion was found both easy and useful. The waxing and waning phases, too, must have excited the curiosity of early peoples, who were unacquainted with the true explanation of even so elemental a phenomenon. Let us now watch our satellite from night to night. A few evenings' observations show how easy it is to find out the general facts of her motion around us.

To observe the Moon's Motion.—The September new moon, first becoming visible in the southwest, will, in about five days, reach the farthest declination south, and culminate near the lowest point on the meridian. Thenceforward, for about a fortnight, she will be farther and farther north each night, journeying at the same time eastward, and in a general way following the ecliptic. During the subsequent fortnight, the moon will be traveling southward, always within the zodiac; and in a little less than a month, will have returned very nearly to the point where we first began to observe. And so on, throughout all time, with a regularity which became useful to the ancients as a measure of time; for our month took its origin from the moon's period round the earth. But her motion is even more useful to the modern world, because employed by navigators on long voyages in finding the position of ships. So important is the moon in this relation that the lives of many great mathematical astronomers have been almost wholly devoted to the study of her motion. Americans prominent in this line of research are Newcomb and G. W. Hill. As soon as the new moon can first be seen in the western sky, make a long, narrow chart of the brighter stars to the east within the zodiac as on the next page. A line drawn eastward from the moon, perpendicular to the line joining the horns of the crescent, called *cusps*, will show this direction accurately enough. Then plot the moon among the stars on the chart each clear night. Also draw the phase as accurately as possible. It is better to chart the position about half an hour later each night. This simple series of observations may continue nearly three weeks, if desired. Much will be learned from it,—position of the ecliptic; progressive phases of the moon; the amount of

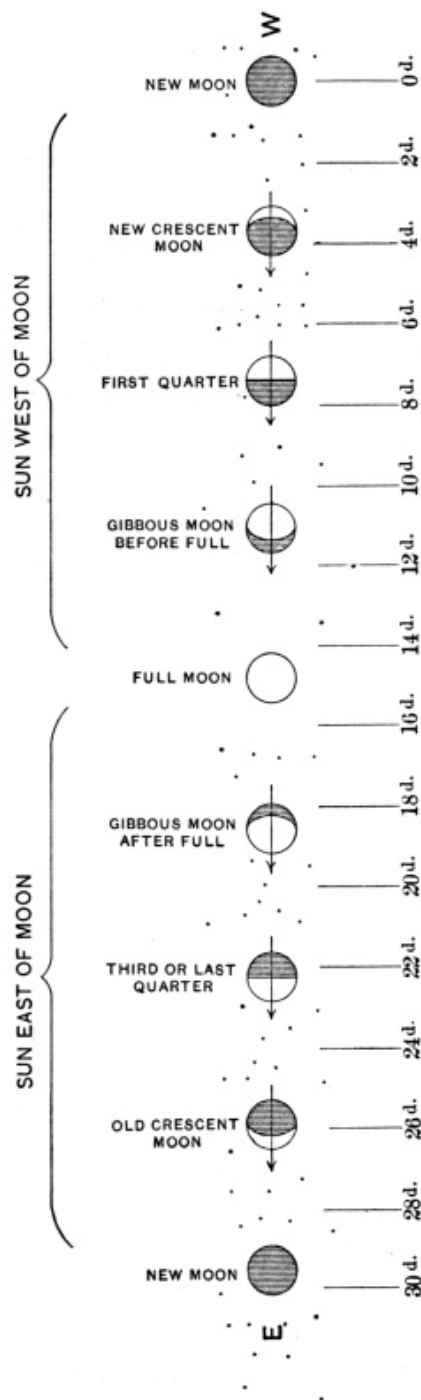

Illustrating the Moon's Eastern Progress
among the Stars from Day to Day

motion each day (about her own breadth every hour, or 13° in a day); and if a telescope is used, the observer will occasionally be rewarded by the opportunity of watching the moon pass over, or occult, a star. Disappearance of a star at the moon's dark limb is the most nearly instantaneous of all natural phenomena.

The Terminator.—Observe the slender moon in the west, as soon as she can be seen in a dark sky. The inside edge of the bright crescent, or the line where the lucid part of the moon joins on the dark or faintly illuminated portion, is called the terminator; and its general curvature is always a half ellipse, never a semicircle.

The moon's terminator is elliptical in figure because it is a semicircle seen obliquely. Any circle not seen perpendicularly seems to be shaped like an ellipse; and the more obliquely it is seen, the more the ellipse appears elongate or drawn out. When turning a curve on your bicycle, observe the changing figure of the shadows of its wheels cast by the sun. Owing to mountains on the lunar surface, the actual terminator, if examined with a telescope, is always a broken, jagged line. This is because sunlight falls obliquely across the rough surface, and all its irregularities are accentuated as if magnified—like pebbles and ruts in the road, at a considerable distance from an arc light.

The Moon's Phases.—The moon's phases afforded travelers

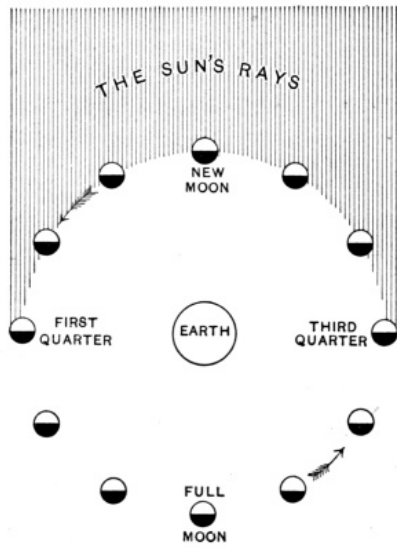

Phases as seen from above Moon's Orbit

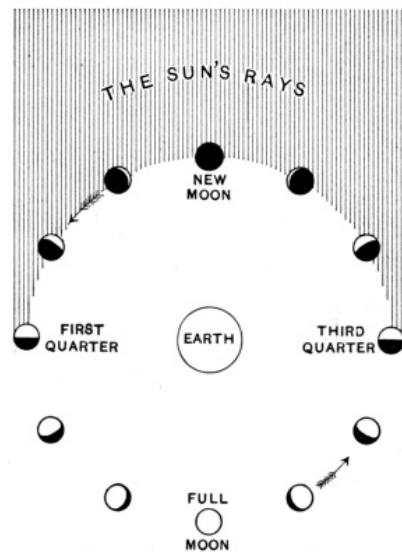

Corresponding Phases from the Earth

Explaining Phases of the Moon

and shepherds the first measure of time. When two or three days after new moon our satellite is first seen in the western sky, her form is a crescent, convex westward or toward the sun, with the horns, or cusps turned toward the east. Three or four days later the slender crescent having grown thicker and thicker, and the terminator less and less curved, the moon has reached quadrature, or first quarter, and her shape is that of a half circle. The terminator is then a straight line, the diameter of this circle. Passing beyond quadrature, the terminator begins to curve in the opposite direction, making the moon appear shaped somewhat like a football, with one side circular and the other elliptical. The eastern edge is the elliptical one, and is still called the terminator. Gradually its curvature increases, the apparent disk of the moon growing larger and larger, until, about a week after first quarter, the phase called full moon is reached. This oblong moon, between first quarter and full, is called gibbous moon. From full moon onward for a week, our satellite is again gibbous in form, but the terminator has now changed to the west side of the lunar disk, instead of the eastern. Then quadrature is reached, and the moon is again a half circle, but turned toward the east, not the west. This phase is known as third quarter. Onward another week to new moon, the figure is again crescent, but curving eastward or toward the sun, and the horns pointing toward the west. All the

figures previously shown—crescent, quarter, gibbous, and full—represent phases of the moon.

Cause of the Moon's Phases.—Our satellite is herself a dark, opaque body. But the half turned toward the sun is always bright, as in the last figure; the opposite half is unilluminated, and therefore usually invisible. While the moon is going once completely round the earth, different regions of this illuminated half of our satellite are turned toward us; and this is the cause of phases of the moon.

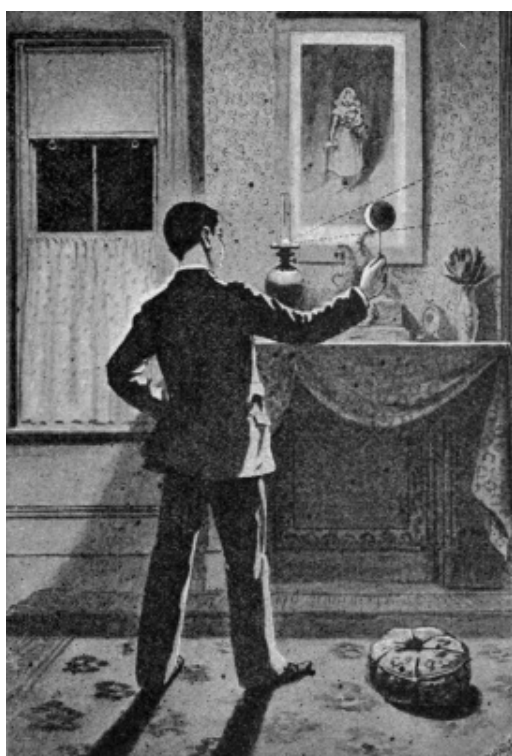

Illustrating the Moon's Progressive Phases

orange is between eye and lamp; first quarter (half moon) when orange is at the left of lamp and at a right angle from it; full moon when orange is directly opposite lamp; last quarter, orange opposite its position at first quarter. When the orange shows a slender crescent, at either old or new moon, shield the eye from direct light of lamp. Again repeat the experiment, and watch the gradually curving terminator from phase to phase. The unpeeled half of the orange, too, represents very well the moon's ashy light, or earth shine on the moon, when a narrow crescent.

To illustrate in simple fashion: accurately remove the peel from the half of an orange. Let a lamp in one corner of a room otherwise dark represent the sun. Standing as far as convenient from the lamp, let the head represent the earth, and the orange held at arm's length, the moon. Turn the white half of the orange toward the lamp. Now turn slowly round toward the left, at the same time turning the orange on its vertical axis, being careful always to keep the peeled side of the orange squarely facing the lamp. While turning round, keep the eye constantly fixed on the white half of the orange, and its changing shape will represent all the moon's successive phases: new moon when or-

Earth Shine.—The nights on the moon are brightened by reflected light from the neighborly earth, and our shining is equal to more than a dozen full moons. This light it is that makes the faint appearance on the moon, as of a dark globe filling the slender crescent of the new moon, causing a phenomenon called ‘the old moon in the new moon’s arms.’ Similarly with the decrecent old moon.

The copper color of the earth-illuminated portion is explained by the fact that the earth light has passed twice through our atmosphere before reaching the moon, and by a peculiar property of the atmosphere, it absorbs bluish rays and allows reddish ones to pass. Always the phase of this portion of the moon is the supplement of the phase of the bright portion. Also its figure is exactly that which the bright earth would appear to have, if seen from the moon. When our satellite is crescent or decrecent to us, the earth shows gibbous to the moon.

North and South Motion of the Moon.—Just as the sun has a north and south motion in a period of a year, so the moon has a similar motion in a period of about a month; for she follows in a general way the direction of the ecliptic. Every one has observed that midsummer full moons always cross the meridian low down, and that the full moons of midwinter always culminate high.

The reason is that the full moon is always about 180 degrees from the sun. Similarly midwinter crescent moons, whether old or new, are always low on the meridian, and crescent moons of midsummer always high. So when in summer you see in early evening the new moon in the northwest, you know that in winter the old moon’s slender crescent must be looked for in the early morning in the southeast. Remember that our satellite from new to full is always east of the sun. And whether the moon in this part of its lunation is to be found north or south of the sun will depend upon the season. For example, the moon at first quarter will run highest in March, because the sun is then at the vernal equinox, and the moon at the summer solstice. For a like reason the first-quarter moon which runs lowest on the meridian will ‘full’ in the month of September.

The Moon rises about Fifty Minutes later Each Day.—Her own motion eastward among the stars, about 13° every day, causes this delay. As our ordinary time is derived from the sun (itself not stationary among the stars, but also moving eastward every day about twice its own breadth, or 1°), therefore the eastward gain of the moon on the sun is about 12° . Now suppose the moon on the eastern horizon at 7 o’clock this evening; then, to-morrow evening at 7, it is clear that if her orbit stood vertical, she would be 12° below the horizon, because in that part of the sky the direction east is downward. But by the earth’s turning round on its axis, the stars come above the eastern horizon at the rate of 1° in four minutes of

time; therefore to-morrow evening the moon will rise at about 50 minutes after 7. And so on, about 50 minutes later on the average each night.

Variation from Night to Night.—Consult the almanac again. In it are printed the times of moonrise for every day. Wait until full moon, and verify these times for a few successive days, if the eastern horizon permits an unobstructed view. Having found the almanac reliable, at least within the limits of error of observation, we may use its calculations to advantage for other days of the year; for on many of these it will not be possible to watch the moon come up, because she rises in the daytime. The difference of rising (or of setting) from one day to another may sometimes be less than half an hour, and again about a fortnight later, a full hour and a quarter.

There are two reasons for this: (1) The apparent monthly path of the moon lies at an angle to the horizon which is continually changing; when the angle is greatest, near the autumnal equinox, a day's eastward motion of our satellite will evidently carry her farthest below the eastern horizon. (2) The moon's path around us is elliptical, not circular, and the earth is not at the center of the ellipse, but at its focus, so that earth and moon are nearest together and farthest apart alternately at intervals of about two weeks. By the laws of motion in such an orbit, the moon travels her greatest distance eastward in a day when nearest the earth (perigee); and her least distance eastward when farthest from the earth (apogee). And this change in speed of the moon's motion also affects the time of rising and setting.

Harvest and Hunter's Moon.—Every month the moon goes through all the changes in the amount of delay in her rising, from the smallest to the largest. But ordinarily these are not taken especial account of, unless at the time when least retardation happens to coincide nearly with time of full moon. Now the epoch of least retardation occurs when the moon is near the vernal equinox, because there the moon's path makes the smallest angle with the eastern horizon. And as sun and full moon must be in opposite parts of the sky, autumn is the season when full moon and least retardations come together.

The daily advance of the moon along the September ecliptic is from 1 to 2, and from 2 to 3. In March the same amount of eastward advance, from 1 to 2', and from 2' to 3', brings the moon much farther below the horizon, and therefore retards the time of rising by the greatest amount, as the dotted lines drawn parallel to the equator show. Similarly the positions at 2 and 3 give the least delay; and this September full moon, rising less than a half hour later each evening, is called the harvest moon. A month later the retardation is still near its least amount for a like reason; and the October full moon is called the hunter's moon. Approaching the tropics, where equator and ecliptic stand more nearly

vertical to the horizon, it is clear that the phenomena of the harvest moon become much less pronounced.

The Moon's Period of Revolution.—The moon revolves completely round the starry heavens in $27\frac{1}{3}$ days (or more exactly 27 d. 7 h. 43 m. 11.5 s.). This is called the *sidereal period* of the moon, because it is the time elapsed while she is traveling from a given star eastward round to the same star again. This motion of the moon must be kept entirely distinct from the apparent diurnal motion, or simple rising in the east and setting in the west; for the latter is a motion of which all the stars partake, and is wholly due to the earth's revolution eastward upon its axis. But our satellite's own motion along her path round the earth is in the opposite direction; that is, from west toward east. A rough value for the sidereal period is easy to determine.

Select any bright star (not a planet) near the moon, and notice the hour when the star and the center of the moon are nearly on the same hour circle; that is, when their right ascensions are about equal. The following month watch for the moon's return to the same star, and find the interval. For example, the moon was seen to be on the same hour circle with Alpha Scorpium on 11th September, 1899, at about 7 P.M. At the same hour on 8th October the moon had not yet reached the star, but was about eight times her own breadth west of it; so star

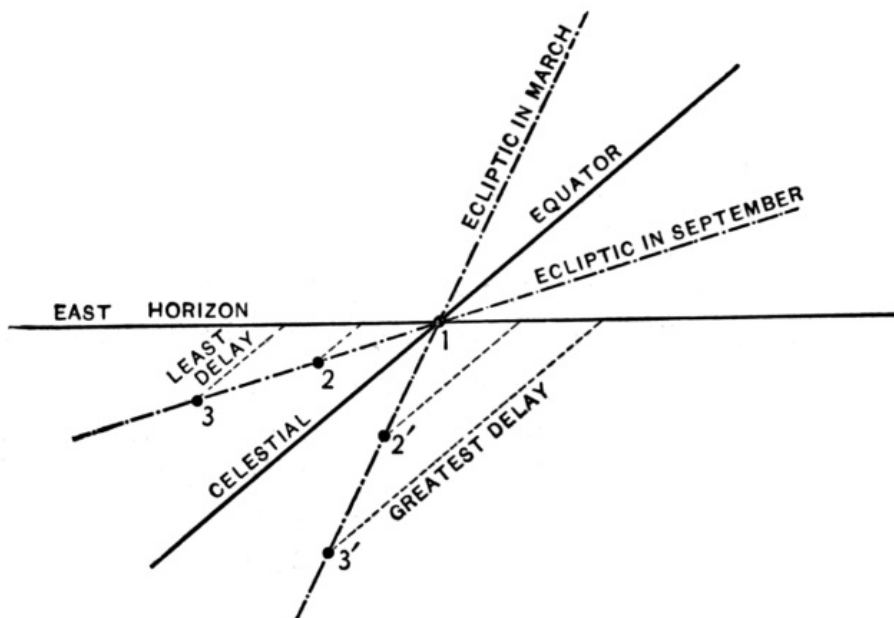

Circumstances of Harvest Moon

and moon were not together till about 3 A.M. of 9th October—an interval of 27 d. 8 h.

The Moon's Synodic Period.—Let sun and moon appear together in the sky as seen from the earth at E , sun being at S , and moon at M_1 . While earth

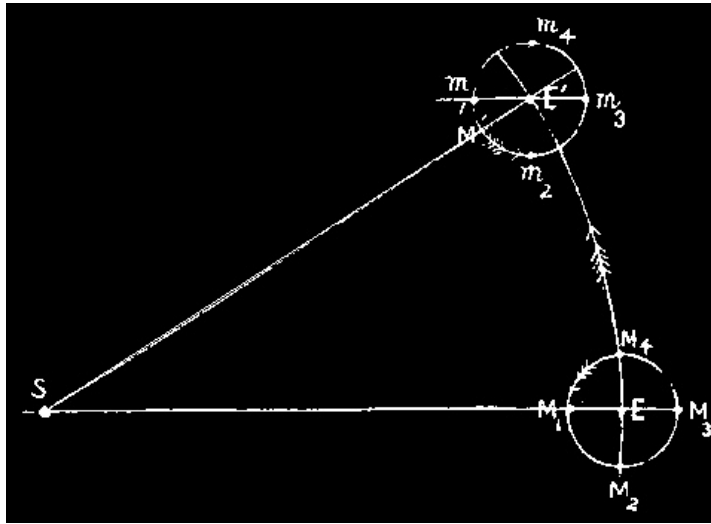

Synodic Period exceeds Sidereal Period

is traveling eastward round the sun in the direction of the large arrow, moon is all the time going round earth in the direction M_1M_2 indicated by the small arrow. When earth has reached E' , moon is at m_1 , and her sidereal period is then complete, because m_1E' is parallel to M_1E . But the sun is in the direction $E'S$. So the moon must move on still further, making the period relatively

to the sun longer than her sidereal period, just as the sidereal day is shorter than the solar day. In round numbers, the sun's apparent motion, while the moon has been traveling round us, amounts to about 30° ; therefore the moon must travel eastward by this amount, or nearly $2\frac{1}{3}$ days of her own motion, in order to overtake the sun.

The period of the moon's motion round the earth relatively to the sun is called the synodic period. It is $29\frac{1}{2}$ days in duration, or accurately 29 d. 12 h. 44 m. 2.7 s., as found by astronomers from several thousand revolutions of the moon. It is an average or mean period, depending upon the mean motion of the sun and the mean motion of the moon; for we shall soon find that our satellite travels round us with a speed far from uniform, just as we found our own motion round the sun to be variable. The synodic period may be roughly verified by observing the times of a given phase of the moon with about a year's interval between them, and dividing by the whole number of lunations. For example, on 12th September, 1899, at about six in the evening, the terminator was judged to be straight, and it was first quarter. Similarly, on 1st October, 1900, at 5 o'clock P.M. Dividing the entire interval of 384.0 days by 13, the number of intervening lunations,

gives a result of 29.54 d., about 0.2 hour in error.

The Lunation.—The term *lunation* is often used with the same signification as the synodic period. More properly the lunation is the period elapsing from one new moon to the next. Its value cannot be found directly by observation, but only from calculation, because at new moon the dark half of our satellite is turned toward us, and the disk is merged in the background of atmosphere strongly illuminated by the sun. Take from any almanac the difference between the times of adjacent new moons at different times of the year. Some of these will be longer and some shorter by several hours than the synodic period. These differences are mainly due to (a) the sun's varying motion along the ecliptic, and (b) the moon's varying motion in her path round the earth.

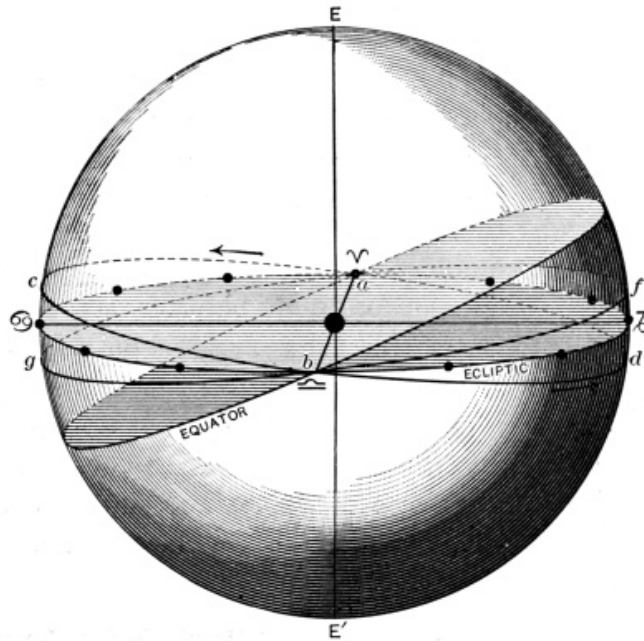

Illustrating Inclination and Nodes of Lunar Orbit

The Moon's Apparent Orbit.—So far the moon's motion has been accurately enough described by saying that its path coincides with the ecliptic. But closer observation will soon show that, twice each month, our satellite deviates from the ecliptic by 10 times her own breadth. This angle, more accurately $5^{\circ} 8' 40''$, is the inclination of the moon's orbit to the ecliptic, and it varies scarcely at all. Just as ecliptic and equator cross each other at two points 180° apart, called the equinoxes, so the moon's path

and the ecliptic intersect at two opposite points, called nodes of the moon's orbit, or more simply the moon's nodes.

In the preceding figure they are represented at a and b , as coincident with the equinoxes, Υ and ϖ . That, however, is their position for an instant only; for they move constantly westward just as the equinoxes do, only very much more rapidly. During the time consumed by our satellite in traveling once around us, the moon's nodes travel backward more than twice the moon's breadth; so that in $18\frac{1}{2}$ years the nodes themselves travel completely round the ecliptic, and return to their former position.

When journeying from south to north of the ecliptic, as from d to c , in the direction indicated by the arrow, the moon passes her *ascending node*, at a . And when going from c to d , she passes her *descending node* at b . When the inclination of the moon's orbit is added to the obliquity of the ecliptic, our satellite moves in the plane $acbd$, in the direction of the arrows; when the inclination is subtracted, she moves in the plane $agbf$. In both cases the nodes coincide with the equinoxes; but in the latter the ascending node has moved round to b , and the descending node to a . Extreme range of moon's declination is from $28^\circ.6$ north to $28^\circ.6$ south.

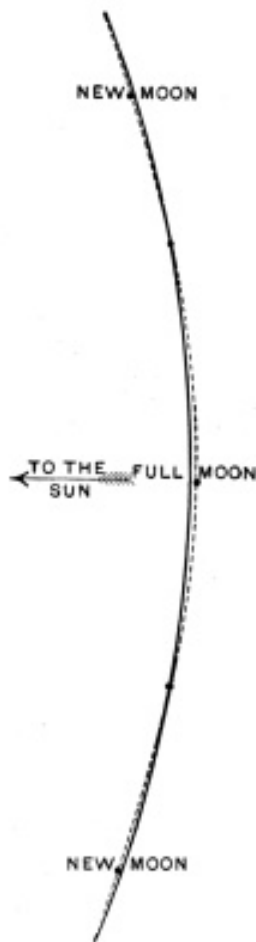

Orbit Concave to Sun,
even at New Moon

Cardinal Points of the Moon's Orbit.—

When our satellite comes between earth and sun, as at new moon, she is said to be in conjunction; at the opposite part of her orbit, with sun and moon on opposite sides of the earth, as at full moon, she is said to be in opposition. Both conjunction and opposition are often called syzygy. Halfway between the syzygies are the two points called quadrature. At quadrature the difference of longitude between sun and moon is 90° ; at the syzygies, this difference is alternately 0° and 180° . The term *syzygy* is derived from the Greek word meaning a yoke, and is applied to these two relations of sun, earth, and moon, when all these bodies are in line in space—or nearly so.

True Shape of the Moon's Orbit in Space.—

If the earth did not move, the moon's orbit in space would be nearly circular. But during the month consumed by the moon in going once around us, we move eastward about $\frac{1}{12}$ of an entire circumference, or 30° . The moon's orbital motion is relatively slow, the

earth's relatively rapid; and on this account the moon winds in and out, along our yearly path round the sun. As that illuminating body is about 400 times more distant than the moon, the true shape of the lunar orbit cannot be shown in a diagram of reasonable size. But a small portion of the orbit can be satisfactorily shown, as above; and it readily appears that the moon's real path in space is always concave to the sun.

Form of the Moon's Orbit round the Earth.—In the case of sun and earth, we found that the shape of our yearly path round him is an ellipse, without knowing anything about our distance from him. In like manner we can find the form of the moon's monthly orbit round the earth. That also is an ellipse.

By measuring the moon's diameter in all parts of her orbit, we shall find variations which can be due only to the changing distance of our satellite from us. The two circles adjacent correspond to extremes of this variation: the moon when nearest to us, is said to be at perigee, and the outer circle represents its apparent size. About a fortnight later, on arrival at greatest distance, called apogee, the moon's apparent size will have shrunk to the inner dotted circle. Evidently the variation of apparent diameter is much greater than that of the sun; therefore the moon's path is a more elongated ellipse than the earth's. We saw that the eccentricity of the earth's orbit is $\frac{1}{60}$: that of the moon's orbit is $\frac{1}{18}$. So great is this variation in distance of our satellite that full moons occurring near perigee are noticeably brighter than those near apogee. While at new moon, as we shall see in Chapter XII, this change of the moon's apparent diameter happens to be very significant; for it produces different types of eclipses of the sun.

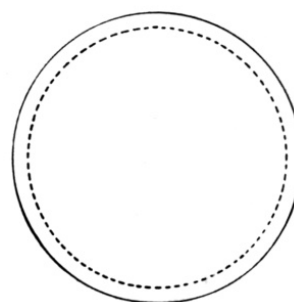

Relative Size at Perigee,
and Apogee (Dotted
Circle)

Distance of the Moon.—Of all celestial bodies, excepting meteors and an occasional comet, the nearest to us is the moon. Astronomically speaking, and relatively, the moon is very near, and yet her distance is too great to be apprehended by reference to any terrestrial standard. As her orbit is elliptical instead of circular, and as the earth is situated in one of the foci of the ellipse, the average or mean distance of the moon's center from the center of our globe is 239,000 miles.

If the New York–Chicago limited express could travel from the earth to the moon, and should start on New Year's, although it might run day and night, it would not reach the moon till about the 1st of September. Recalling definitions of the ellipse previously given, it will be remembered that the mean distance is

not the half sum of the greatest and least distances, but the mean of the distances at all points of the orbit. Also it is equal to half the major axis of the orbit. But in traveling round the earth, our satellite is not free to pursue a path which is a true ellipse, for the attraction of other bodies, in particular the sun, pulls her away from that path. So the moon's center sometimes recedes to a distance of 253,000 miles, and approaches as near as 221,000 miles.

What is Parallax?—The moon's distance is found by measuring the parallax. Parallax is change in apparent direction of a body due to change of the point of observation. It is by no means so puzzling as it may look.

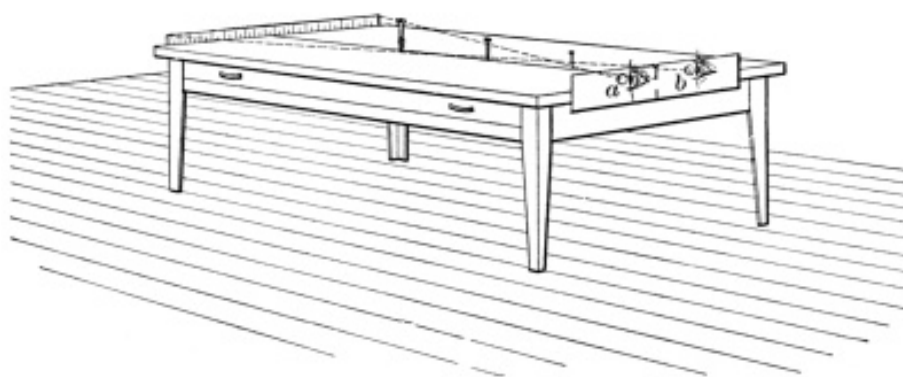

Parallax decreases as Distance increases

Place a yardstick on its edge at the farther side of a table, as shown. Set up a pin, a nail, and a screw, at convenient intervals; the nail at twice, and the screw at three times, the distance of the pin from the notch in the card between the eyes. It is better if notch, pin, nail, and screw are in a straight line nearly at right angles to the yardstick at its middle point. First, from the aperture in the card at *a*, observe and set down in a horizontal line the readings of pin, nail, and screw, as projected against the rule; then repeat the observation from *b*, in the same order, setting down readings in line underneath. Screw, nail, and pin all seem to change their direction as seen from the two apertures. This apparent change of direction is parallax; it is the angle formed at the object by lines drawn from it to each eye. Now take the differences of the pairs of readings as they stand: the difference of the pin readings is twice that of the nail readings, and three times that of the screw readings. Parallax, then, is less, the farther an object is removed from the base, or line joining the two observation points. And considering these points fixed, we reach the general law that—

The parallax of an object decreases as its perpendicular distance from the base of observation increases.

The Moon's Equatorial Parallax.—In measuring celestial distances, obviously it is for the interest and convenience of all astronomers to agree

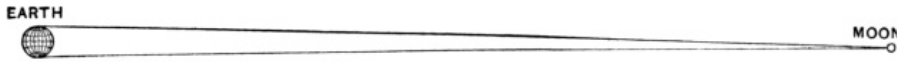

Size and Distance of Earth and Moon in True Proportion

upon some standard by which to measure and indicate parallaxes. Such a standard line has been universally adopted; it is the radius of the earth at the equator. The moon's parallax, then, is the angle at the center of that body subtended by the equatorial radius of the earth. This constant of lunar parallax is nearly a degree in amount ($57' 2''$). It means that an astronomer, if he could take his telescope to the moon and there measure the earth, would find its equator to fill twice the angle of the moon's equatorial parallax; that is, the earth would be $1^\circ 54'$ in diameter—an angle correctly represented in the slim figure on this page.

Moon's Parallax at Different Altitudes.—Whatever the latitude of the place, the moon's parallax is the angle filled by the radius of the earth at that place, as seen from the moon. When moon is in horizon, that radius AC (preceding diagram) is perpendicular to the horizon AB , and the parallax AMC is consequently a maximum, called the horizontal parallax. Higher up, as at M' , change in apparent direction of the moon, as seen from A and C , is less; that is, the parallax is less. With the moon at M'' , in the zenith, the parallax becomes zero, because the direction of M'' is the same, whether viewed from A or C . Thus we derive the important generalization, true for sun and planets as well as moon: *For a heavenly body at a given distance from the earth's center parallax increases with the zenith distance.*

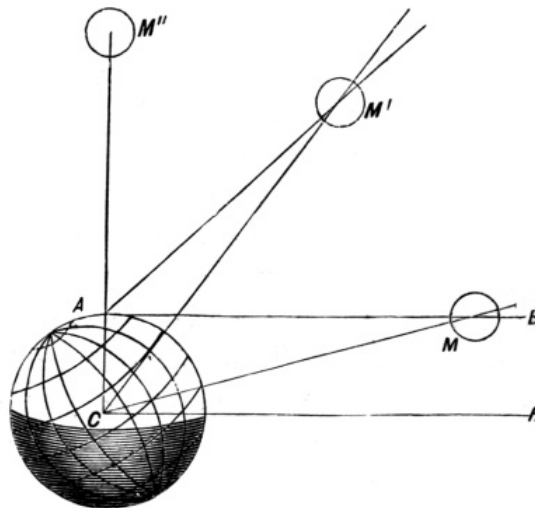

Parallax increases with Zenith Distance

Parallax lessens the Altitude.—True altitude of the moon and other bodies is measured upward from the rational horizon to the center of the body. In the diagram on the previous page, these altitudes are HCM , HCM' , and HCM'' . But as seen from the point of observation A , the moon's apparent altitudes are 0° at B , BAM' , and BAM'' . It is clear that these altitudes must always be less than the true altitudes, except when moon is in zenith. And by inspection we reach the general proposition that parallax lessens altitude, and its effect decreases as altitude increases, until it becomes zero when the body is exactly in the zenith. Both parallax and refraction vanish at the zenith; but at all other altitudes, their effects are just opposite, refraction always seeming to elevate, and parallax to depress, the heavenly bodies.

How the Distance of the Moon is found.—By precisely the principle of the illustration on page 208 is the distance of the moon from the earth found—that is, by calculation from its parallax. And the parallax can be found only by observations from two widely distant stations on the earth.

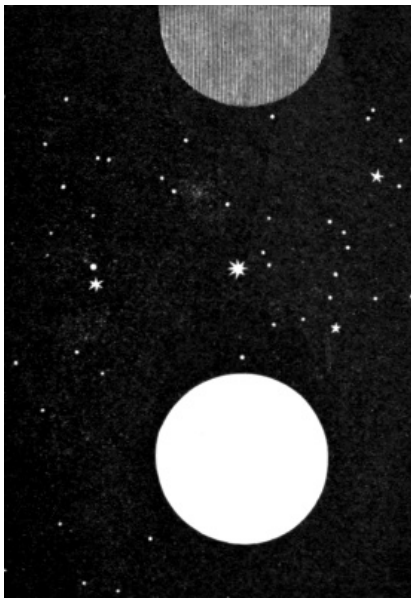

Moon as seen from Berlin and
Capetown

Imagine a being of proportions so huge that his head would be as large as the earth. Then think of his two eyes as two observatories; for example, Berlin and Capetown, one in the northern and one in the southern hemisphere. Also imagine the moon to take the place of the screw and replace the divisions on the rule by fixed stars. Evidently then, the observer at Berlin will see the moon close alongside of different stars from those which the Capetown observer will see adjacent to the edge. The amount of displacement can be judged from this illustration, which shows the well-known group of stars called the Pleiades in the constellation Taurus. The bright disk represents the moon as seen from Berlin, the darker disk where seen from Capetown. As the angular distances of all these stars from each other are known, the angular displacement of the moon in the sky (or its parallax referred to

the line joining Berlin and Capetown as a base) can be found. Now the length of this straight line, or chord, through the earth's crust is known, because the size of the earth is known. So it is evident that the distance of the moon can

be calculated from these data. The process, however, requires the application of methods of plane trigonometry. It was primarily for the purpose of finding the moon's distance that the Royal Observatory at Capetown was founded by the British government early in the 19th century.

Moon's Deviation from a Straight Line in One Second.—As the moon's distance from the earth is approximately 240,000 miles, the circumference of her orbit (considered as a circle) is 1,509,000 miles. But our satellite passes over this distance in 27 d. 7 h. 43 m. 11.5 s.; therefore in one second she travels 0.640 mile. In that short interval how far does her path bend away from a straight line, or tangent to her orbit?

Suppose that in one second of time the moon would move from *S* to *T*, if the earth exerted no attraction upon her. On account of this attraction, however, she passes over the arc *St*. This arc is 0.640 mile in length, or about $0''.5$ as seen from the earth; and as this angle is very small, the arc *St* may be regarded as a straight line, so that *StU* is a right angle. Therefore

$$SU : St :: St : Ss.$$

But *SU* is double the distance of the moon from us; therefore *Ss* is 0.053 inch, which is equal to *Tt*, or the distance the moon falls from a straight line in one second.

So that we reach this remarkable result: The curvature of the moon's path is so slight that in going $\frac{6}{10}$ of a mile, she deviates from a straight line by only $\frac{1}{20}$ of an inch.

Dimensions of the Moon.—First her apparent diameter is measured: it is somewhat more than a half degree (accurately, the semidiameter is $15' 32''.6$). But the moon's parallax, or what is the same thing, the angle filled by the earth's radius as seen from the moon, is $57'$. So that, as the length of the earth's radius is 3960 miles, we can form the proportion—

$$\left\{ \begin{array}{l} \text{Radius of earth} \\ \text{as seen from} \\ \text{moon} \end{array} \right\} : \left\{ \begin{array}{l} \text{Radius of moon} \\ \text{as seen from} \\ \text{earth} \end{array} \right\} :: \left\{ \begin{array}{l} \text{Length of earth's} \\ \text{radius in miles} \end{array} \right\} : \left\{ \begin{array}{l} \text{Length of moon's} \\ \text{radius in miles} \end{array} \right\}$$

$$57 \quad : \quad 15.5 \quad :: \quad 3960 \quad : \quad 1077$$

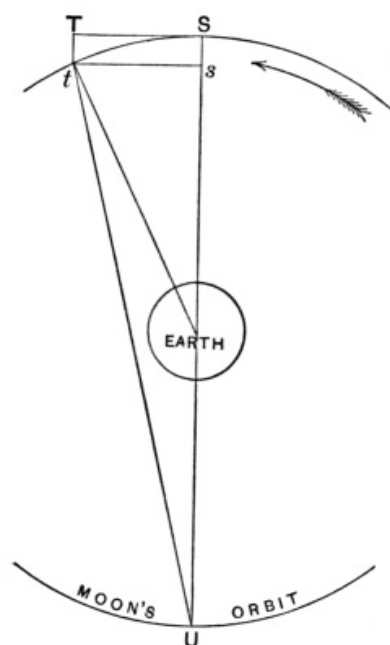

Fall of Moon in One Second

The diameter of the moon, therefore, from this proportion is 2154 miles. A more exact value, as found by astronomers from a calculation by trigonometry is 2160 miles. The moon's breadth, then, somewhat exceeds one fourth the diameter of our globe. So far as known, the diameter is the same in all directions; that is, the moon is spherical. As surfaces of spheres vary with the squares of their diameters, the surface-area of our satellite is about $\frac{1}{14}$ that of our planet, or $4\frac{1}{2}$ times that of the United States. The bulk of the moon is only $\frac{1}{49}$ that of the earth, because volumes of globes vary as the cubes of their diameters.

To measure the Moon's Diameter.—You need not take the diameter of the moon on faith: measure it for yourself. When our satellite is within a day or

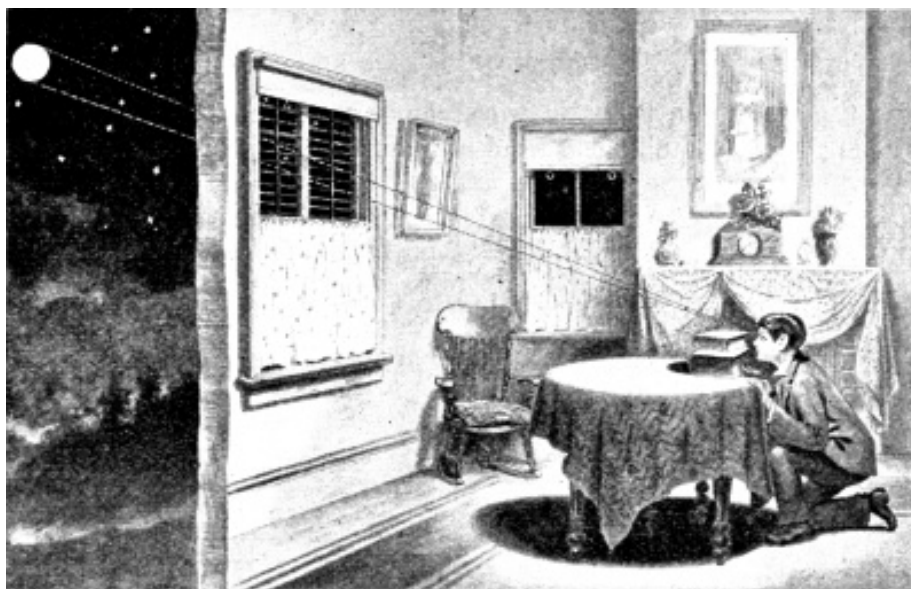

Measuring the Moon's Diameter without Instruments

two of the full, select a time from a half hour to three hours after moonrise. Open a window with an easterly exposure, close one of the shutters, and turn its slats (opposite the open sash) so that their planes shall be directed toward the moon. The observation now consists of four parts: (1) so placing the head that the moon can be seen through the slats, (2) making the distance of the eye from the window such that the moon will just seem to fill the interval between two adjacent slats, (3) measuring the eye's distance from the slats, (4) measuring the distance of the slats from each other. A pile of books will be a help in fixing the point where the eye was when making the observation. Placing the head beyond the books, and about seven feet from the sash, move slowly away from the window till the moon just fills the space between two adjacent slats. Or if size of the room will allow,

let the moon fill the space between two slats not adjacent. Make a mark on the frame of the shutter between these slats. Bring the pile of books close up to the eye so that a near corner of the top book may mark where the eye was. Next thing necessary is a non-elastic cord about 15 feet long. Tie one end to the slat or frame, near mark just made, then draw it taut to corner of pile of books where the eye was. Measure along the cord the distance (in inches) of the eye from the slats. Also measure perpendicular distance (in inches) between the inner faces of the two slats marked. Then approximate diameter of moon (in miles) is found from the following proportion:—

$$\left\{ \begin{array}{l} \text{Distance of} \\ \text{slats from} \\ \text{the eye} \end{array} \right\} : \left\{ \begin{array}{l} \text{distance of} \\ \text{slats from} \\ \text{each other} \end{array} \right\} :: 239,000 : \left\{ \begin{array}{l} \text{diameter of} \\ \text{the moon} \\ \text{(in miles)} \end{array} \right\}$$

Repeat observation at least twice, moving pile of books each time, adjusting it anew, and measuring distance over again.

Measures of the Moon and their Calculation.—On 26th January, 1899, at about 6 o'clock P.M., or an hour after the moon had risen, the following measures were made:—

Distances of shutter from eye.	Perpendicular distance between inner faces of slats.
(1) 139.5 inches	$1\frac{1}{4}$ inches.
(2) 136	<u>239,000</u>
(3) <u>137</u>	<u>59,750</u>
137.5 average	137.5) <u>298750</u>
	2170

So the moon's diameter from these crude measures is 2170 miles, only about $\frac{1}{200}$ part too great.

Why the Moon seems Larger near the Horizon.—Because of an optical illusion. With two strips of blank paper, cover everything near the bottom of this page except the line of dots. Before reading further, decide which seems longer, xy or yz ?

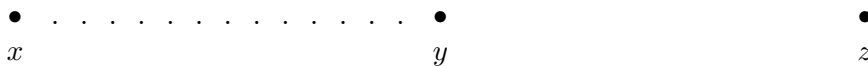

Distance almost invariably seems longer if there are many intervening objects. For example, xy seems longer than yz , because xy is filled with dots, and yz is not. Thus horizon appears to be more distant than zenith, because the eye, in looking toward the horizon, rests upon many objects by the way. This accounts for the apparent flattening of the celestial vault. Now the moon near the horizon and at the zenith is seen to be the same object in both positions; but when near the horizon she seems larger because the distance is apparently greater, the mind

unconsciously reasoning that being so much farther away, she must of course be larger in order to look the same. Often the sun is seen through thick haze or fog near the horizon, and a like illusion obtains. But we know that the true dimensions of these bodies do not vary in this manner, nor do their distances change sufficiently. And whether illusion of sun or moon, it is easy to dispel. Roll a thin sheet of paper round a lead pencil, making a tube about 12 inches long. With one eye look through this tube at the much-enlarged sun or moon near the horizon; instantly the disk will shrink to normal proportions. Then close this eye and open the other—as instantly the illusion deceives again. Repeat the

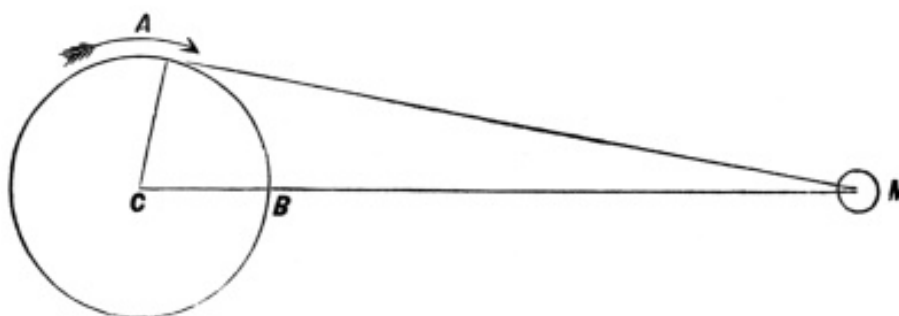

Why the Moon is really largest at the Zenith

experiment, opening and closing the eyes alternately as often as desired; the eye behind the tube is never deceived, because it sees only a narrow ring of sky round the moon, and the tube cuts off all sight of the intervening landscape.

Moon Larger at Zenith than at Horizon.—The actual fact is just the reverse of the illusion; for if the moon's horizontal diameter is measured accurately when near the horizon, it is actually less than on the meridian. The above diagram makes this at once apparent. The moon at *M* is in the horizon of a place *A* on the surface of the earth, and in the zenith of *B*, which may be conceived the same as *A*, after the earth has turned about 90° on its axis. As *M* is nearer *B* than *A* by almost the length of the earth's radius, or nearly 4000 miles, clearly the zenith moon must be larger than the horizon moon by about $\frac{1}{60}$ part because *CB* is about $\frac{1}{60}$ of *CM*.

The Moon's Mass.—The mass of the moon is 81 times less than that of the earth; partly because of her smaller size, and partly because materials composing our satellite are on the average only three fifths as dense as those of the earth.

Gravity at the moon's surface is about $\frac{1}{6}$ that of the earth: it is only $\frac{1}{81}$ as great because of the moon's smaller mass; but greater by 14 times because, as will be explained in a later chapter, gravity increases as the square of the distance from the center of attraction becomes less; and the square of the moon's radius is

about 14 times less than the square of the earth's. Surface gravity on the moon is therefore $\frac{14}{81}$, or about $\frac{1}{6}$, that on the earth. So a man weighing 144 pounds would weigh only 24 pounds on the moon, if weighed by a spring balance. An athlete who is lauded for his running high jump of 78 inches could, with no greater expenditure of muscular energy, jump 39 feet on the moon. Probably this deficiency of attraction at the moon's surface explains, too, why many of the lunar mountains are much higher than ours. Our satellite's attraction for the oceans of the earth, producing tides, is a basis of one method of weighing the moon. Another method is by the moon's influence on the motion of the earth: when in advance, or at third quarter the moon's attraction quickens our motion round the sun as much as possible; when behind the earth in its orbit, or at first quarter, our satellite retards our orbital motion round the sun by the greatest possible amount.

Axial Rotation.—Our globe revolves on its axis a little more than $27\frac{1}{3}$ times as swiftly as the moon does. For while our sidereal day is 23 h. 56 m. long, the moon's sidereal day is equal to $27\frac{1}{3}$ of our 24-hour days; that is, the moon turns round once on her axis while going once round the earth.

The simplest sort of an experiment will clearly illustrate this: let a lighted lamp represent the sun; the teacher standing in the middle of the room represent the earth; and let a pupil, representing the moon, walk slowly around the teacher in a circle, the pupil being careful to keep the face always turned toward the teacher. It will readily be seen that the pupil while walking once around has turned his face in succession toward all objects on the wall. In other words, he will have made one slow revolution on his own axis in exactly the same time it took him to walk once completely round the teacher. So the two motions being accomplished in just the same time, a given side of the moon is always turned toward the earth, just as the face of the pupil was always toward the teacher. So, too, the opposite side of our satellite is perpetually invisible to us.

Librations.—By a fortunate dip of the moon's axis to the plane of the orbit, however, we are sometimes enabled to see a little more of the region, now around one pole, and now around the other. The inclination is $83^{\circ} 21'$, and our ability to see somewhat farther over, as it were, arises from this *libration in latitude*. Again, the rate of the moon's motion about the earth varies, while her axial turning is perfectly uniform, so that one can see around the edge farther, alternately on the western and eastern sides; this is called *libration in longitude*. When the moon is near the zenith, there is little or no effect of libration due to position of observer on the earth. When, however, the moon is in the horizon, observer is nearly 4000 miles above the plane passing through earth's center and the moon. Consequently he can see a little farther around the western limb at moonrise and around

the eastern limb at moonset. This effect is known as *diurnal libration*. As a sum total of the three librations, about four sevenths of the moon's entire surface can be seen in all.

No Lunar Atmosphere.—One reason for our believing that the moon has no atmosphere is this: when our satellite passes over a star (or occults it, as the technical expression is), disappearance at the edge of the moon is exceedingly sudden. There is no dimming of the star's light before it is extinguished, as there would be if partly absorbed by lunar air and clouds. The spectroscope, too, shows no change in the star's spectrum when it is close to the moon's edge. Also during solar eclipses, the moon's outline seen against the sun is always very sharply defined. Some writers have thought it possible that there may be traces of water and atmosphere yet lingering at the bottom of deep valleys, but no observations have yet confirmed this hypothesis. Perhaps the moon, in some early stage of her history, had an atmosphere, though not a very extensive one; and it may have been partly absorbed by lunar rocks during the process of their cooling from an original condition of intense heat, common to both earth and moon. Observations show that a possible lunar atmosphere cannot exceed in density $\frac{1}{5000}$ that of the earth.

Why No Air and Water on the Moon.—Supposing that these elements once surrounded the moon in remote past ages, their absence from our satellite at the present time is easy to explain according to the kinetic theory of gases, accepted by modern physicists. This theory asserts that the particles of a gas are continually darting about in all possible directions. The molecules of each gas have their own appropriate or normal speed, and this may be increased as much as seven fold in consequence of their collisions with one another. From the known law of attraction it is possible to calculate the velocity of a moving body which the moon is capable of overcoming; if a rifle ball on the moon were fired with a velocity of about 7000 feet per second, or three times the speed so far attained by artificial means on the earth, it would leave our satellite forever, and pursue an independent path in space. Physicists have ascertained that the molecules of all gases composing the atmosphere can have velocities of their own far exceeding this limit; and as earth and moon are many millions of years old, it is easy to see how the moon may have completely lost her atmosphere by this slow process of dissipation. Surface attraction of the moon, only one sixth that of the earth, has simply been powerless to arrest this gradual loss. The possible speed of molecules of hydrogen is greatest, and even exceeds the velocity which the earth is able to overcome; so that this theory explains, too, the absence of free hydrogen in our own atmosphere. Water on the moon would gradually become vaporized into atmosphere, and complete disappearance as a liquid may readily

have taken place in this manner. Whether it may be present in the form of ice, it is not possible to say.

The Moon's Light and Heat.—The amount of moonlight increases from new to full more rapidly than the illumined area of the moon's disk; so our satellite at the quarter gives much less than half her light at the full. Mainly, this is due to gradually shortening shadows of lunar elevations, which vanish at the full. As is very apparent to the eye at this phase, some parts of the moon are much darker than others; but on the average, the lunar surface reflects about one sixth of the sunlight falling upon it. The spectroscope shows no difference in kind between moonlight and sunlight. The brightness of the full moon is deceptively small, being at average distance only $\frac{1}{600,000}$ that of the sun. Heat from the full moon is nearly four times greater than the amount of light, and the larger part of it is heat, not reflected, but radiated from the moon as if first absorbed from the sun. Our satellite having no atmosphere to help retain this heat, it radiates into space almost as soon as absorbed, so that temperature at the lunar surface, even under vertical sunlight, probably never rises to centigrade zero. At the end of the fortnight during which the sun's rays are withdrawn, temperature must drop to nearly that of interplanetary space, probably about 300° below zero. In America Langley and Very are foremost in this research.

The Moon and the Weather.—A wide, popular belief, hardly more than mere superstition, connects the varying position of the lunar cusps with the character of weather. The line of cusps is continually changing its angle with the horizon, according to the relation of ecliptic (or moon's orbit) to the horizon, as already explained; and it is impossible, therefore, to see how or why this should indicate a wet moon or a dry moon. As for changes of weather occasioned by, or occurring coincidentally with, the moon's changing phases, one need only remember that the weekly change of phase necessarily comes near the same time with a large per cent of weather changes; and these coincidences are remembered, while a large number of failures to coincide are overlooked and forgotten. Weather, too, is very different at different localities, and probably there is always a marked change going on somewhere when our satellite is advancing from one phase to another. Critical investigation fails to reveal a decided preponderance either one way or the other, and any seeming influence of the moon upon weather is a natural result of pure chance. The full moon, too, is popularly believed to clear away clouds; but statistical research does not disclose any systematic effect of this nature. Moon's apogee and perigee are known to occasion a periodic disturbance of magnetic needles, and may possibly be concerned in the phenomena of earthquakes; but the latter effect is not yet fully established.

Surface of the Moon.—In days of earlier and less perfect telescopes,

darker patches very noticeable on the moon's disk were named seas, and these titles still cling to them, although it is now known that they are only desert plains, and not seas. All the more important features can be accurately located from the accompanying illustration. Since great modern

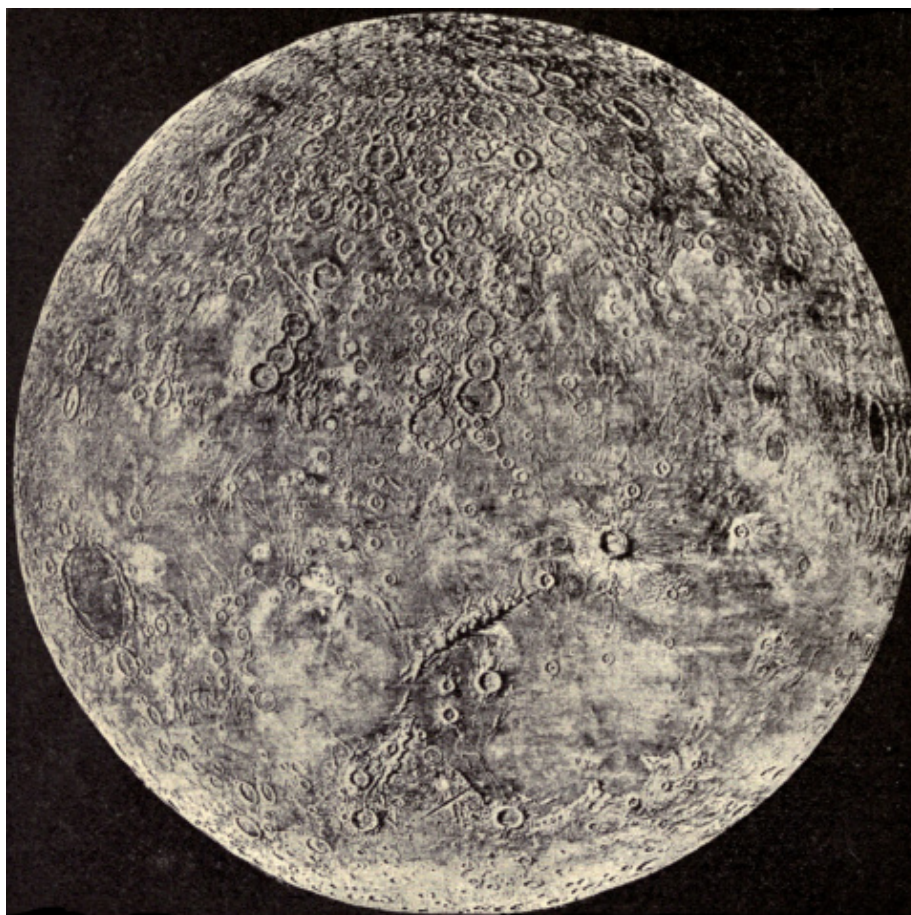

Telescopic Features of the Moon as seen in an Inverting Telescope

telescopes, using a power of 1500 bring the moon within about 150 miles, much detail can be seen in the inexpressibly lonely scenery diversifying our satellite. A great city might be made out, but the greatest building ever built on our earth could not be seen except as a mere speck. Also the best modern photographs, like those reproduced on pages 14 and 220, are amply sufficient for critical study; and examination of them is much more satisfactory than the ordinary view through a telescope. The 'seas,' so-called, may in truth be the beds of primeval oceans, which have dried up and disappeared hundreds of thousands of years ago. They are not all at

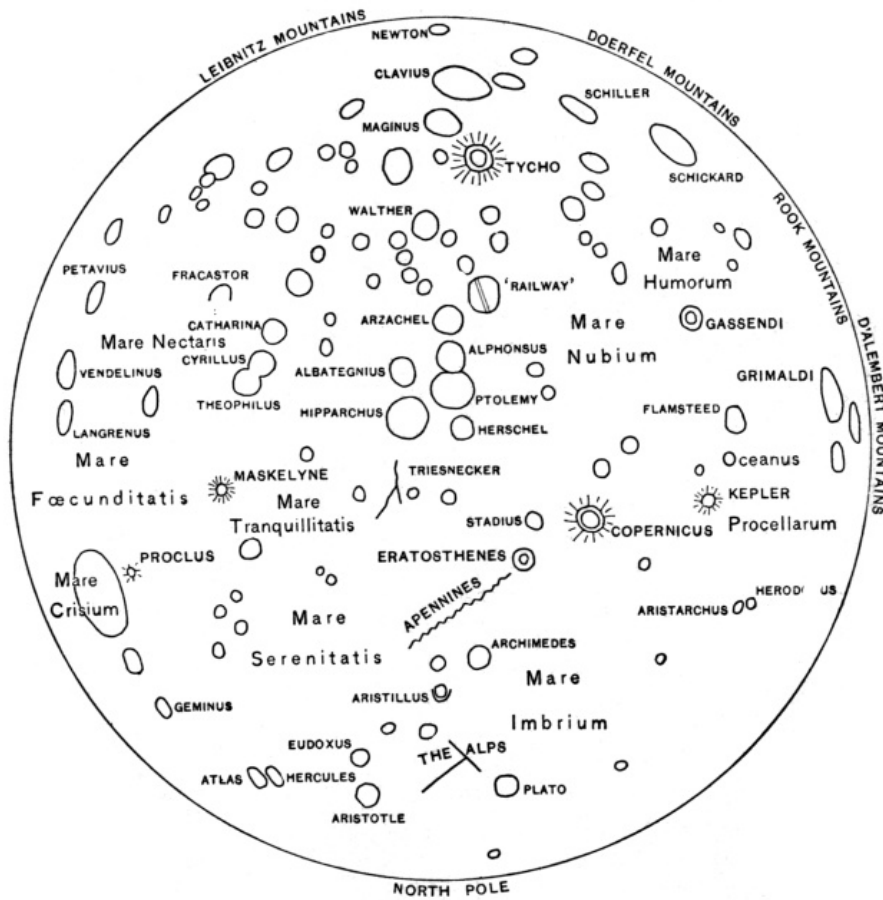

Key to the Chart of the Moon Opposite

the same level. Earlier stages of cosmic life are characterized by intense heat; but as development of the moon progressed, original heat gradually radiated into space, leaving her surface finished. Evidently she has gone through experiences some of which the earth may already have known, and through others still in our remote future. Being so much smaller than the earth, as well as less in mass, our satellite cooled much faster than the parent planet. A few surface features are to be explained as due to the consequent shrinkage.

Maps and Photographs of the Moon.—All the lunar mountains, plains, and craters are mapped and named; and astronomers are quite as familiar with 'Copernicus' and 'Eratosthenes' (a great, crater, and a mountain nearly 16,000 feet high) as geographers are with Vesuvius and the Matterhorn. Hevelius of Danzig made the first map of the moon in 1647.

He named the mountains and craters and plains after terrestrial seas and towns and mountains. But Riccioli, who made a second lunar map some

time after, renamed the moon's physical features, immortalizing in this way himself and many friends. His names, with numerous modern additions, are still current.



Moon's North Cusp (photographed by the Brothers Henry of the Paris Observatory)

One astronomer has counted 33,000 craters on the moon, of course on only the four sevenths of her surface ever turned toward us; and as there is no reason for supposing the remainder to contain features differing in kind from those on the hemisphere so familiarly known, probably there are not less than 60,000 craters on the entire surface of our satellite. During the last half century many astronomers have interested themselves in producing photographs of the moon, with very remarkable success. By an exposure of a second or two, a vast degree of detail is secured with perfect accuracy, which the pencil could not depict in months; indeed, critical study with a microscope has

pencil could not depict in months; indeed, critical study

brought to light lesser features of hill and valley which had escaped the eye and the telescope alone. Photographic maps or atlases of the moon on a very large scale have recently been published by the Paris Observatory, the Lick Observatory, and the Prague Observatory; and the material already accumulated will, in the present century, show any considerable changes, should such be taking place.

Changes on the Moon.—Probably the observers who a century ago recorded volcanoes in activity and progressive changes on the moon were deceived by the highly reflective character of materials forming the summits of certain mountains. Some craters are alleged to have disappeared, and in other instances new craters to have formed; but evidence has in no case amounted to absolute proof as yet. It is still an open question whether surface activity of any kind characterizes the lunar disk, except perhaps on a very small scale, too minute for detection with present instrumental means. Varying conditions of illumination by the sun are so marked, even from hour to hour, that nearly all reputed changes are sufficiently explained thereby. Size and power of the telescope, and in drawings the personal equation of the artist, together with the state of atmosphere, all tend to introduce elements making sketches far from comparable.

The Mountains on the Moon.—Although of all the satellites of the solar system, the moon is nearest the size and mass of its primary, still this

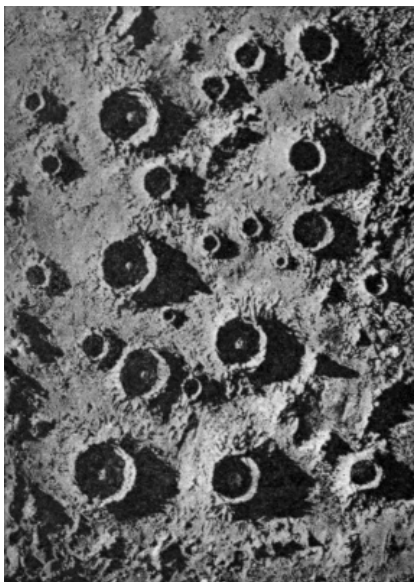

Lunar Volcanoes

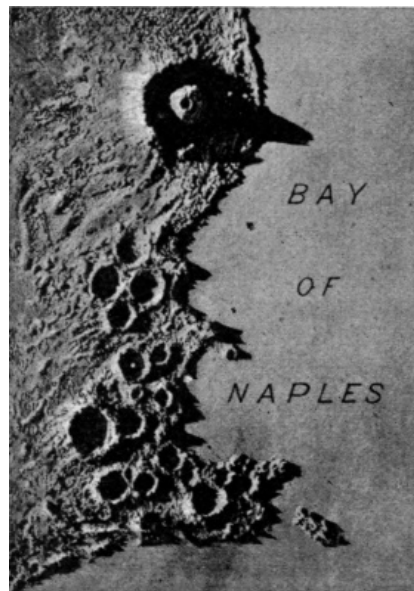

Terrestrial Volcanoes

neighbor world is no copy of the present earth. The difference between them

is accentuated in the character of their mountains—on the earth ridges and mountain chains for the most part, with relatively few craters; on the moon quite the reverse, craters being far in excess. In large part they seem to be volcanic in formation, but many of the largest ones with low walls are probably ruins of molten lakes. When the mountains of the moon are illuminated by a strong cross-light—as along the terminator at sunrise and sunset—they are thrown into sharp relief, as in this picture of lunar volcanoes, set opposite a model of Vesuvius and neighboring volcanoes photographed under like circumstances of illumination. Similar volcanic origin is self-evident.

Nearly 40 lunar peaks are higher than Mont Blanc, and the greater relative height of lunar than terrestrial peaks is doubtless due to lesser surface gravity of our satellite. The Leibnitz Mountains, perhaps the highest on the moon, are 30,000 to 36,000 feet in elevation, much exceeding the highest peaks on earth. As there is no softening atmospheric effect, shadows of all lunar objects are so sharply defined that the height, depth, and extent of nearly all natural features of the moon's surface can be accurately measured.

To find the Height of a Lunar Mountain.—Heights of many mountains on the moon have been found by this method: with a suitable instrument, called

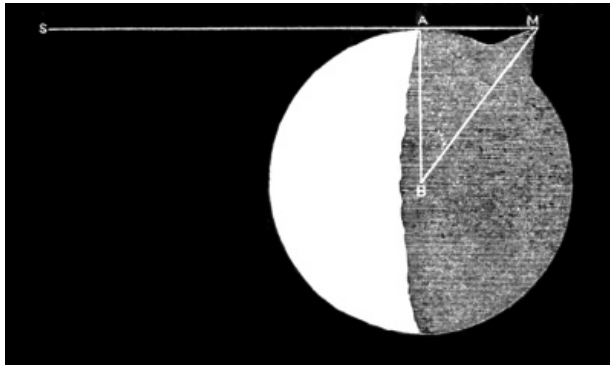

Measuring Height of a Lunar Mountain

the micrometer, attached to the telescope for measuring small arcs, measure AM , distance of terminator from peak of a mountain which sunlight from S just grazes. Length of moon's radius AB is known, and distance AM is given by the measures. So the value BM , or moon's average radius as increased by the height of

mountain, can be found by solving the right-angled triangle ABM .

A Typical Crater highly magnified.—Somewhat north and east of the center of the lunar disk is the great crater Copernicus. Rising from its floor is a cluster of conical mountains about 2500 feet high. The walls of the crater itself are about 50 miles in diameter, and 13,000 feet high. As the drawing on the facing page shows, the surroundings of Copernicus are rugged in the extreme, and near full moon a complex network of bright streaks may be seen extending more than a hundred miles on every side. They do not appear in the illustration because it was drawn near the quarter. The streaks do not radiate from the great crater itself, but from

some of the craterlets alongside, by which Copernicus is especially thickly surrounded. Probably the streaks are due to light-colored gravel or powder scattered radially. Most of the adjacent craterlets are very minute, and they are counted by hundreds.

The Lunar Cliffs or Rills and Other Features.—Almost at the center of the moon, but slightly toward the northwest, is Triesnecker, a well-pronounced crater, along the west side of which is the remarkable cliff system shown on page 224. Their radiation and intersection

are strongly marked—chasms about a mile in breadth, and nearly 300 miles in length. Little is known about their nature and even less about their origin. The bottom of the cliffs is seen to be nearly flat, presenting to some extent the appearance of an ancient river bed. The few mountain chains on the moon resemble those on the earth in one respect: they are much steeper on one side than on the other, as if the tiltings had been similarly produced. Craggy and irregular pyramids are sparsely scattered on the plains. There are many valleys, some wide and deep, others mere clefts or cracks.



Region Surrounding Copernicus (highly magnified)

The term *rill* is often applied to them although waterless, and there are many hundreds, passing for the most part through seas and plains, though occasionally intersecting the craters. Some are straight, others bent and branching. Possibly they are fissures in a surface still shrinking. In a few in-

stances, the geological feature known as a fault may be observed—the crack is not an open one, and the surface on one side is higher than on the other. Also there are walled plains, from 40 to 150 miles in diameter, with interiors generally level, but broken by slight elevations and circular pits or depressions. Nearly the entire visible surface is astonishingly diversified by clean-cut irregularities looking much as if neither water nor atmosphere had ever been present on the moon. Even a small telescope helps greatly in examining them, and their position on or near the terminator is most favorable for their study. Intervals of a double lunation, or 59 d. $1\frac{1}{2}$ h. bring the terminator through very nearly the same objects, so that the nature and extent of illumination are comparable.

If One were to visit the Moon.—Of course no human being could visit the moon without taking air and water along with him. But what we know about the surface of our satellite enables us to describe some of the natural phenomena.

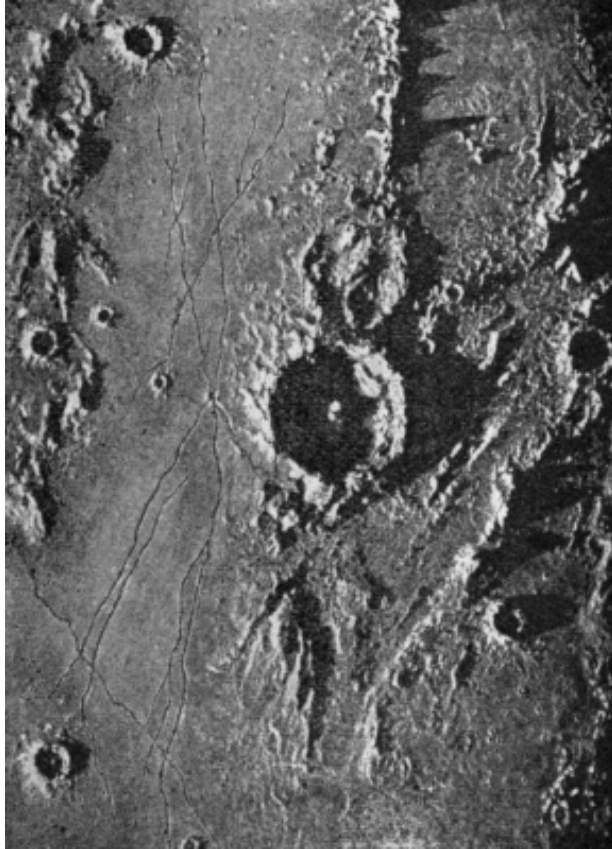

Triesnecker and Lunar Rills

stars would be appreciably brighter than here, in a perpetually cloudless sky. Even the fainter ones would be visible in the daytime quite as well as at night. If one were to land anywhere on the opposite side of the moon and remain there,

Absence of atmosphere means no diffused light; nothing could be seen unless the direct rays of the sun were shining upon it. The instant one stepped into the shadow of a lunar crag, he would become invisible. No sound could be heard, however loud; in fact, sound would be impossible. A landslide, or the rolling of a rock down the wall of a lunar crater, could be known only by the tremor it produced—there would be no noise. So slight is gravity that a good player might bat a baseball half a mile without trying very hard. Looking up, the

the earth could never be seen; only by coming round to the side toward our planet would it become visible. Even then the earth would never rise or set at any given place, but it would constantly remain at about the same altitude above the lunar horizon. Earth would go through all phases that the moon does here, only they would be supplementary, full earth occurring there when it is new moon here. Our globe would seem to be about four times as broad as the moon appears to us. Its white polar caps of ice and snow, its dark oceans, and the vast but hazy cloud areas would be conspicuous, seen through our upper atmosphere. Faint stars, the filmy solar corona, also the zodiacal light, would probably be visible close up to the sun himself; but although his rays might shine for a fortnight without intermission upon the lunar landscape, still the rocks would probably be too cold to touch with safety.



Typical Lunar Landscape (full Earth)

From the chief luminary of our nightly skies, we turn to an investigation of discoveries made by astronomers concerning the orb of day, describing at the same time instruments and processes of the 'new astronomy' with which many of these researches have been conducted.

Chapter XI

The Sun

Man in the ancient world worshiped the sun. Primitive peoples who inhabited Egypt, Asia Minor, and western Asia from four to eight thousand years ago have left on monuments evidence of their veneration of the 'Lord of Day.' Archæologists have ascertained this by their researches into the world of the ancient Phœnicians, Assyrians, Hittites, and other nations now passed from earth. A favorite representation of the sun god among them was the 'winged globe,' or 'winged solar disk,' types of which are well preserved on the lintels of an ancient Egyptian shrine of granite in the temple at Edfu. In the Holy Scriptures are repeated allusions to the protecting wings of the Deity, referring to this frequently recurring sculptured design; and we know that if his life-giving rays were withheld from the earth, every form of human activity would speedily come to an end.

The Sun dominates the Planetary System.—The sun is important and magnificent beyond all other objects in the universe, not only to us, inhabitants of the earth, but to dwellers on other planets, if such there be. All these bodies journey round him, obedient to the power of his attraction. Upon his radiant energies, lavishly scattered throughout space as light and heat, is dependent, either directly or indirectly, the existence of nearly every form of life activity; and the transformation of solar energy produces almost every variety of motion upon the earth, whether animate or inanimate. The more primitive the civilization, the more apparent is the dependence of man upon the sun.

Activities in Labrador here pictured are an excellent illustration. Without the sun's vitalizing action, the trees, whose trunks and branches furnished the load on the sled, not to say the sled itself, could not have grown. The food, whether animal or vegetable, upon which the life and energy of man and dog depend, would not have been possible without the sun. Creatures of land and sea, whose skins provided the straps by which the sled is drawn, could not long live without warmth and vitality lavished by the sun. Nor must we overlook the farther fact

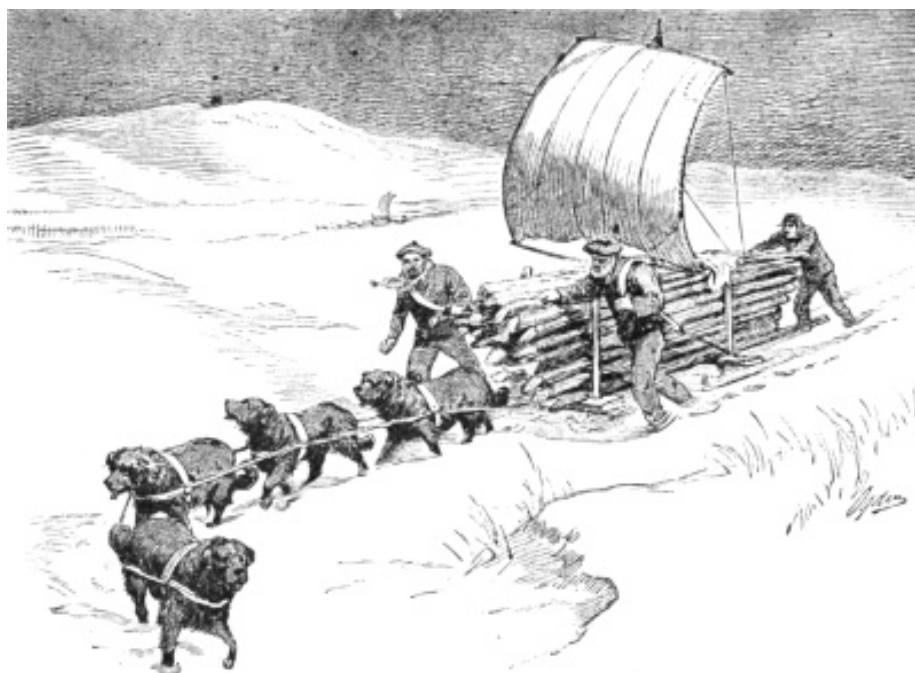

In Labrador (Activities originating in the Sun)

pertaining to natural movements and phenomena of the air; for the sun provides even the breeze to bulge the sail, and he has raised from the sea and diffused over the land the moisture which descends as snow, for the sled to slide upon. In the complicated life of our higher civilization, the sun is still all-powerful, though the links in the chain of connection are in places concealed. Our comforts and activities are largely dependent upon heat given out by burning coal; but it was through the action of the sun's rays that forests in an early geologic age could wrest carbon from the atmosphere and store it in this permanent mineral form, so useful—one might almost say necessary—in the processes of modern life. In everything material the sun is our constant and bountiful benefactor.

Sun's Distance the Unit of Celestial Measurement.—The distance between centers of sun and earth is the measuring unit of the universe. Although motions and relative distances of heavenly bodies may be known, still their true or absolute distances cannot be found with accuracy, unless the fundamental unit is itself precisely determined. It is as if one were to try to measure the size of a house with a lead pencil; it would be possible to find the dimensions of the house in terms of the lead pencil, but the actual size of the building would not be known until the length of the pencil, or unit of measure, had been ascertained. The distance of the sun

is this unit. A method of finding the distance of the moon has been given, but the sun's distance is too great to be measured in this way—even the whole diameter of the earth is not long enough to form a suitable base for the slender triangle drawn from its antipodes to the sun.

For the proper application of this method of finding distances, the triangle included between distant object and the two ends of the base line, must be well-conditioned. Such a triangle is shown in the figure, in which the width of an impassable stream is found by measuring on the left bank a distance nearly equal to the breadth of the stream itself. An ill-conditioned triangle is one whose base is very short in comparison with its other two sides. Such a triangle is shown on page 209, where the base (or earth's diameter) is only $\frac{1}{30}$ of the other sides. Base remaining the same, the farther away the object, the more ill-conditioned the triangle. As the sun is nearly 400 times farther than the moon, the relation of base to other sides is only $\frac{1}{11000}$. The triangle is, therefore, so ill-conditioned that this direct method of finding the sun's distance becomes inapplicable, and other methods are always relied upon.

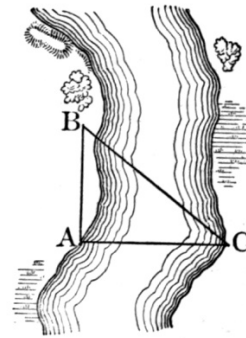

Well-conditioned
Triangle

Finding the Sun's Parallax.—On those rare occasions when Venus, a planet nearer the sun than our earth is, comes in her path exactly between us and the sun, she moves like a small black dot across the shining disk. This happens but twice in each century. Two observers widely separate on our globe, will see Venus projected upon different portions of the sun's disk at the same time; as on page 208, pin is seen against different parts of scale when viewed through the two peepholes. So the apparent path of Venus across the sun will be farther south on the disk, as seen from northern station; and farther north as seen from southern one. Difference of the two paths leads by suitable calculation to a knowledge of the angle which radius of the earth fills, as seen from the sun. This angle is called the sun's parallax. Its value at the average distance of the sun is called the mean parallax. The equatorial radius of our planet is taken, as the standard, the same as in the case of the moon; also when the sun is on the horizon its parallax is a maximum, called the horizontal parallax. The accepted value of the sun's mean equatorial horizontal parallax is $8''.8$. This means that the sun is so remote that if one could visit him and look in the direction of the earth, our globe would appear to be only $17''.6$ broad, an angle so small as to be invisible to the naked eye. A telescope magnifying at least four or five diameters would be necessary to see it.

The Sun's Distance.—The sun's parallax and the length of earth's radius are data for a calculation by trigonometry, giving the distance of the sun equal to 93,000,000 miles. Also this important element may be found by *aberration*. Knowing the velocity of light, it is easy to calculate the speed which the earth must have in order to produce the known amount of aberration of the stars, called the constant of aberration. So it is found that the earth's actual velocity is something over $18\frac{1}{2}$ miles in a second. From this the length of the circumference of the orbit traversed by the earth in $365\frac{1}{4}$ days or one year is readily found, and from that the diameter of the orbit, the half of which is the mean distance of the sun. There are many other and more complicated methods of obtaining the distance of the sun, and they all agree within a small percentage of error. Subtracting $0''.01$ from the parallax is equivalent to increasing the sun's distance about 105,000 miles, and *vice versa*.

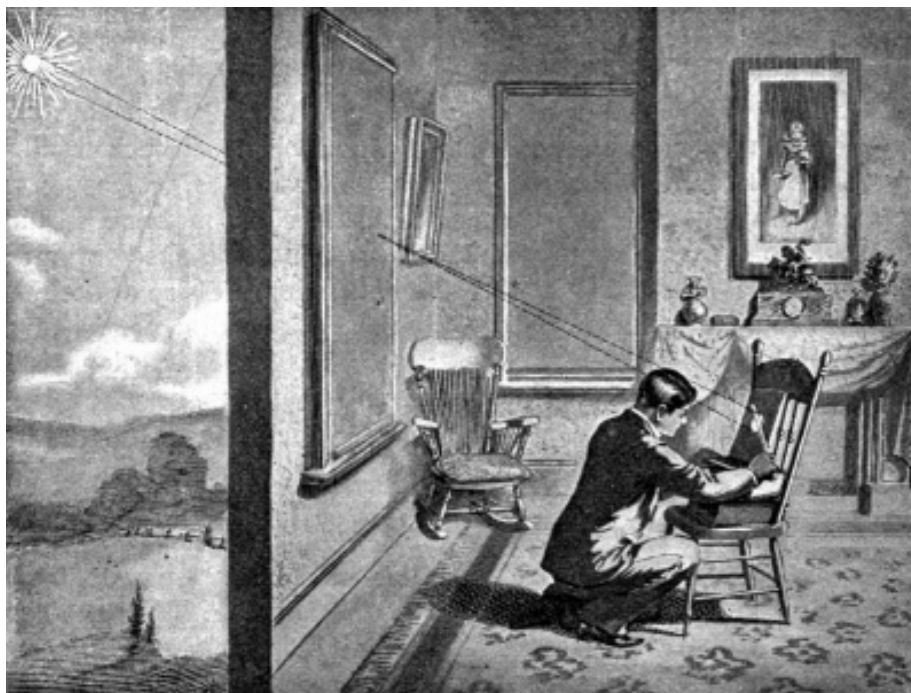

As Distance from shade is to Size of Image, so is Sun's Distance to his Diameter

To measure the Size of the Sun.—Knowing the distance of the sun, it is very easy to observe and calculate his real dimensions. The method is similar to that by which the size of the moon was measured; and different only because of the superior intensity of the sun's light. Instead of looking directly at the sun, simply look at the image produced by the sun's rays through a tiny aperture.

Every one has noticed sunlight filtering into a darkened room through chinks between the slats and frame of a blind or shutter. Oftentimes a series of oval disks may be seen on the floor. Their breadth depends upon (*a*) the diameter of the sun, and (*b*) their distance from the shutter. Each oval disk is a distorted solar image. If a sheet of paper is held at right angles to the direction of the sun, the oval disk becomes circular, and its diameter can be measured. But as the paper is carried toward the shutter, notice that the disk grows smaller and smaller. So you must measure its distance from the shutter also. Select a time when the sun is not exactly facing a window, but is a little to the right or left of it, though not more than an hour in either direction. On closing the shutters, and turning the slats, the chain of disks on the floor will usually become visible. Examine them carefully when projected on a small white card, and select the one which has the sharpest outline. Or, the blinds may be thrown open, and sunlight admitted through a pin-hole in the shade, as in last illustration. Attach a sheet of white paper to the cover of a book; so support it that the surface of the paper shall be at right angles to the line from book to sun. With a sharply-pointed pencil, mark two short parallel lines on the paper, a little farther apart than the diameter of the bright disk. Move the paper back until the sun's image just fills the space between the two lines. Measure distance between lines; also with a non-elastic cord, measure distance from shade to paper on the book. This completes the observation.

Calculating the Observation.—As in calculating the size of the moon when its distance is known, so in computing the dimensions of the sun, only the 'rule of three' is necessary. On 22d May, 1898, size of a pin-hole image of sun was measured and found to be 1.175 in. in diameter. Distance between the card on which the image fell and the aperture in shade was 10 ft. 5.4 in. So the proportion is—

$$125.4 : 1.175 :: 93,000,000 : x.$$

The value of x comes out 871,000 miles, or about $\frac{1}{140}$ part too great. But this amount of error is to be expected, because the method is a crude one. Notice, however, its exactness in principle. To convey an adequate idea of the sun's tremendous proportions is practically impossible.

How Astronomers measure the Sun.—The principle of their method is exactly the same as that just illustrated; and their results are more accurate only because their instruments are more delicate, and training in the use of them thorough and complete. The latest and best value of the sun's diameter is 865,350 miles.

The best method utilizes an instrument called the heliometer, or sun measurer. It is a telescope of medium size, mounted equatorially; but the essential point of difference is in the object glass, AB , which is divided exactly in the middle. Accurate mechanical devices are provided by which B can be slipped

sidewise relatively to *A*, as in the lower figure, and the precise amount of the motion recorded. Before the halves of the glass are moved apart, the sun's image

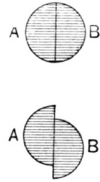

Divided Object Glass
of Heliometer

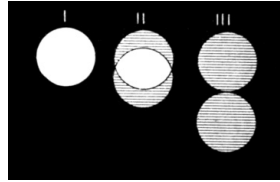

Images of Sun in
Heliometer

is a single, very bright disk, like the left hand of the three here shown. Turn the screw separating the halves of the glass, and overlapping images appear, as in the middle figure; and by turning it far enough, the two images of the sun may be brought into exact exterior contact, as in the right hand of the three images.

Final calculation of the sun's diameter is a tedious and complicated process, because a great variety of conditions and corrections must be taken into account; but the heliometer is the most accurate measuring instrument employed by modern astronomers. The limit of accuracy of measurement with the heliometer is an angle no larger than that which a baseball would fill at New York as seen from Chicago.

The Sun is a Sphere.—As the sun turns round on his axis, equatorial diameters are measured in every direction. As they do not differ appreciably from the polar diameter, the figure of the sun is a sphere. His real diameter is not subject to change; but as already shown, the sun's apparent diameter varies from day to day, in exact proportion to our change of distance from him. The mean value is almost $32' 0''$ (according to Auwers, $31' 59''.26$).

The actual diameter of the sun is difficult to determine, for a variety of reasons. The heat of his rays disturbs the atmosphere through which they travel, so that his outline, or limb, is rarely seen free from a quivering or wave-like motion. Another reason is irradiation, a physiological effect by which bright objects always seem larger than they really are. Irradiation increases as brightness of the object exceeds that of the background against which it is seen. Error in our knowledge of the sun's diameter is probably about $\frac{1}{1000}$ part of the whole, or about $2''$. At the distance 93,000,000 miles, $1''$ of arc is equivalent to 450 miles, so that the amount of uncertainty in the diameter of the sun is about 900 miles.

The Sun's Volume, Mass, and Density.—As the sun's diameter is nearly 110 times greater than that of the earth, his volume is almost 1,300,000 times greater, because volumes of spheres vary as cubes of their diameters. A method of measuring the mass of the sun is given on page 338. To put it simply, the sun's mass is found by measuring the force of his

attraction. If sun and earth are at the same distance from a given body, the sun will attract it 330,000 times more powerfully than the earth does. Sun's weight, in other words, is 330,000 times as great as earth's. A body falling freely under the influence of the sun's attraction would on reaching him have a velocity of 383 miles a second. As the sun is 1,300,000 times greater in volume than the earth, evidently he must be much less dense than our globe; and his component materials, bulk for bulk, must be about one fourth lighter than those of the earth. As compared with water, the sun is rather less than $1\frac{1}{2}$ times as dense.

Gravity at the Sun's Surface.—The weight of the earth, it will be remembered, is 6×10^{21} tons. But the sun weighs 330,000 times as much,—a numerical result which the human mind is utterly powerless to grasp. Another comparison will help to fix relative proportions in memory. Many planets are vastly larger and more massive than the earth. But if all the planets of the solar system and their accompanying retinues of satellites were fused together into a single ball, it would weigh but $\frac{1}{750}$ as much as the sun. So vast are the dimensions of our central luminary that the force of gravity at the surface is not so great as his prodigious mass would seem to indicate: it is only $27\frac{2}{3}$ times as great as gravity at the surface of the earth. A body would fall vertically 444 feet in the first second. Recall the agile athlete who, when transferred to the moon, executed a record jump of 39 feet: if at the sun, he would find his movements hampered by a bodily weight of two tons, and his 'running high jump,' if possible at all, could not exceed three inches. On the sun, the pendulum of an ordinary mantel clock would quiver or oscillate so rapidly that its vibrations could not easily be counted. For every tick of the escapement here, there would be five at the sun.



Viewing the Surface of the Sun

How to observe the Sun.—Unless the telescope is provided with a special eyepiece, called a helioscope, it is dangerous to look at the sun directly, because heat rays coming through the dense colored glass covering the eyepiece are very harmful to the delicate rods of the retina. Besides this, the colored glass is liable

to be broken suddenly by the intense heat. If such accident happens while the eye is at the telescope, a dark spot in the retina is pretty sure to result; and it will remain permanently insensitive—an extreme case of ‘over-exposure.’ Rather look at the sun’s surface indirectly, by projection, as in the picture. To the telescope tube attach a cardboard screen, two or three feet square, and fill the chinks around the tube with cloth or paper. This large screen tightly fastened to the tube, is very necessary to keep direct light of the sun from falling upon the sheet of paper below, on which the sun’s image is projected. This sheet may be held in the hand; but it is better to attach it to a light frame, which slides along a stick firmly screwed to the side of the telescope tube. Then the paper

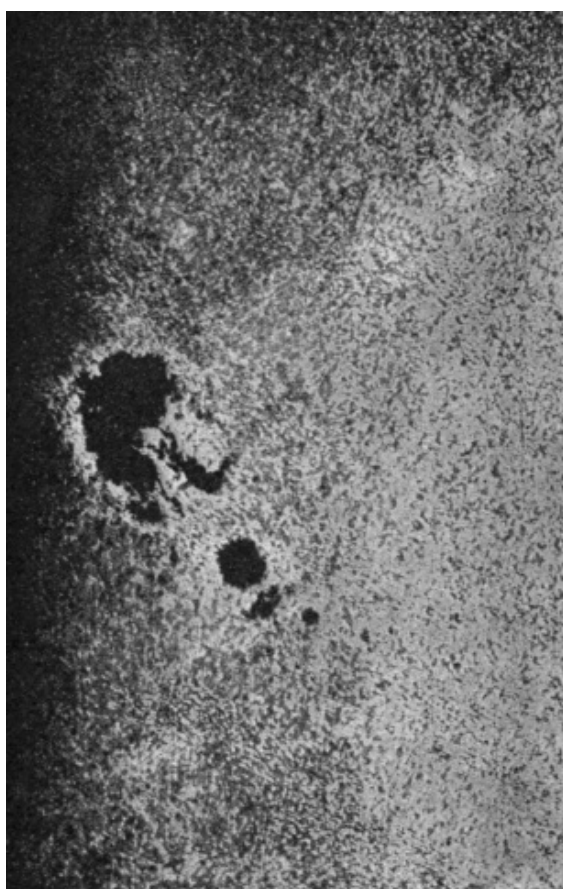

Photosphere (photographed by Janssen)

may be kept always at right angles to the axis of the telescope; and spots may be made to look larger or smaller by merely sliding the frame toward or from the eyepiece. Careful focusing is important, and probably it will be necessary to refocus every time the distance between paper and eyepiece is changed. Ten or twelve persons can readily observe sun spots in this way at the same time, and without the slightest danger or inconvenience. Surface mottlings and faculæ, or white spots, are finely seen. If the telescope is a large one, the eyepiece should occasionally be taken out and cooled; but even a spyglass will gather enough light to show the spots and other details of the sun’s surface.

The Photosphere.—

The photosphere is that mottled exterior of the sun which radiates its light. The photo-

into granules. Floating above the photosphere, and quite numerous around the sun's limb, may usually be seen a number of irregularly connected whitish spots, or patches, called faculæ. It is certain that some of the faculæ are elevations, because they have been seen projecting beyond the edge of the disk. As will be shown farther on, the faculæ extend in zones all the way across the sun; but they are more obvious at the limb, because general illumination of the photosphere in that region is less, owing to greater thickness of solar atmosphere through which rays from the photosphere must pass.

Sun Spots.—Immense dark spots are frequently seen on the photosphere. Generally they have a dark center, called the umbra, and a somewhat lighter fringe, called the penumbra, which is darker near its outer edge, lighter toward the umbra, and often shows a thatch-work structure, as in Secchi's drawing (also page 11). Of widely varying shapes and sizes, they are usually nearly circular at the middle stage of existence, though more irregular at beginning and end.

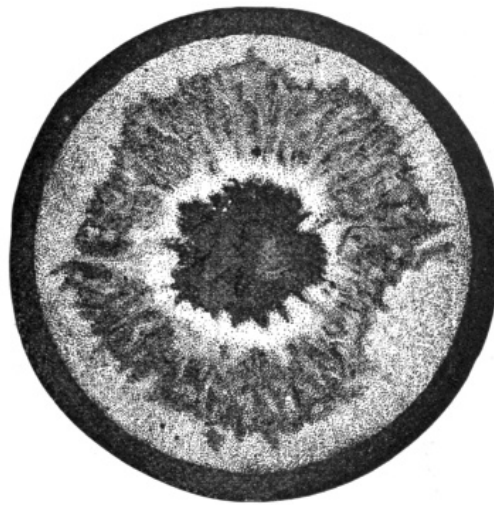

Sun Spot highly magnified (Secchi)

The dark umbra is not all equally dark; at times faint patches or grains of luminous matter appear to float above the darker region underneath. Also sometimes appear tiny round spots, darker than the umbra, known as nuclei—perhaps openings into still greater depths; for the spots themselves nearly always appear like depressions in the photosphere, and on several occasions have been seen as actual notches at the edge of the sun, as in Figure 11.9. There is good evidence, however, that many of them are not depressions. If a spot is as large as 27,000 miles in diameter, it can be seen without a telescope as a very minute black speck. Occasionally spots are even larger than this, and 50,000 miles is a size not unknown. The largest sun spot on record was observed in 1858; it was nearly 150,000 miles in breadth and covered about $\frac{1}{35}$ of the whole surface of the sun.

Veiled Spots.—Veiled spot is the name given to hazy, darkish patches appearing now and then upon all parts of the solar disk, even close to the poles. They have been seen to change their ill-defined outlines very rapidly. Not extensively observed as yet, they are nevertheless regarded as kin to ordinary spots, only that the forces producing them are not intense enough to disrupt the photosphere. Faculæ are often seen above them.



Many Spots are seen as Depressions at the Sun's Limb

Formation and End of Spots.—Each spot or group of spots has its independent method of formation. Perhaps very gradual, through many weeks, spots have yet been known to attain full proportions in a few hours. When completed, they are roughly circular; but as their end draws near, the surrounding matter seems to approach and crowd upon the umbra, as if to tumble pell-mell into its cavernous depths. Very likely this is what actually happens. Often tongue-like encroachments of the penumbra force themselves across the umbra (illustrated in process on page 11); and this usually indicates the beginning of a rapid decline and disappearance. The chasm seems to be filled; and only a slightly disturbed surface (surrounded by faculæ or white spots, which soon disperse) remains for a brief time to indicate very indefinitely the place where the spot existed. Sun spots are easiest of all solar phenomena to observe. Sometimes exceptional disturbance sets up a motion so rapid and violent that vast changes have been seen within a few minutes' time, even while the observer was watching.

Duration and Distribution of Spots.—Often spots are carried across the face of the sun in its rotation, and they become elliptical by foreshortening as they approach the edge and disappear. Figure 11.10 shows how this takes place. If a spot lasts a fortnight or more, it will again come into view when the sun's rotation shall have carried it halfway round. On reappearing at the eastern limb, a spot is elliptical and very narrow at first, and gradually it seems to broaden into its actual shape on facing the earth more and more squarely. The spots are, on an average, two or three months in duration, though very often lasting only a week, or perhaps even a few days or hours. The longest on record lasted 18 months, in the years 1840 and 1841. Spots do not appear on every part of the sun's disk, but they are nearly always confined to zones on both sides of the solar equator, extending from latitude 5° to 30° . The spots are most numerous in solar latitude 15° , both north and south, and a few more are seen in the northern than the southern hemisphere.

The sun's equator is tilted about 7° to the ecliptic, so that the spot zones

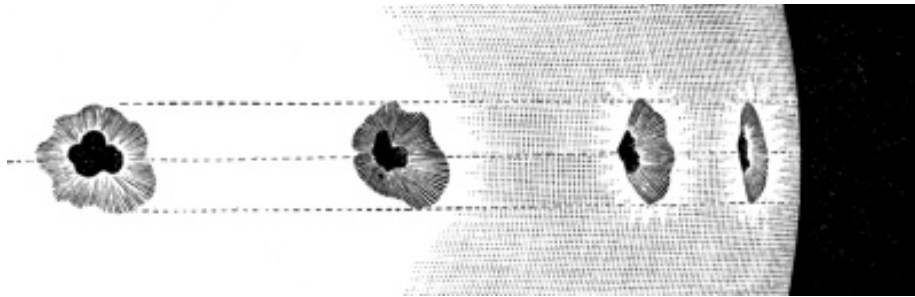

The Same Spot near Sun's Center and Edge

appear sometimes straight and sometimes curved on the sun's disk, as the four figures show, for different seasons of the year. Early in March the sun's south pole, and early in September his north pole, is turned farthest toward us. The axis of the sun, if prolonged northward, would cut the celestial sphere near Delta Draconis. In April the sun's axis is inclined about 25° west of the hour circle passing through his center; in October, about the same amount to the east of it.

Periodicity of the Sun Spots.—Spots are not always equally numerous on the surface of the sun. At times they may be counted by hundreds, and again days, and even weeks, will elapse without a single spot being visible. A well-established period is now recognized. Spots diminish in number slowly, all the while appearing at lower and lower latitudes on the sun, and they pass through a minimum at about latitude 5° both north and south. Then rather suddenly there is an outbreak of spots, in latitude about 30° on both sides of the sun's equator, followed by a growth in number and size of the spots to a maximum, after which again comes the decline in number, size, and latitude. As a new outbreak in high latitudes usually begins about two years before final disappearance of the zones of low latitude, it follows

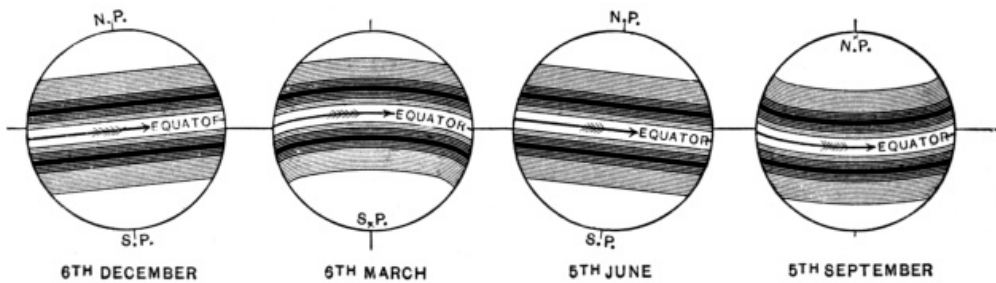

Apparent Motion of Spots across the Sun

that near minimum the spots, although few in number, are distributed in four narrow belts, two of low and two of high latitude. The complete round,

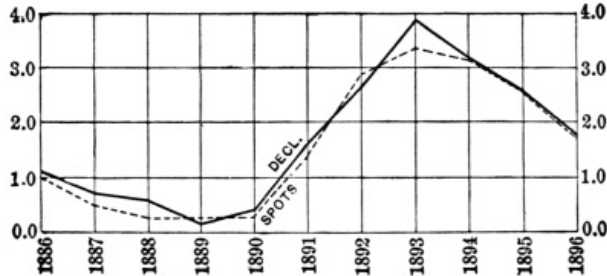

Curve of Sun Spots and Magnetic Declination

or spot period, is eleven years and one month in duration. From minimum to maximum is usually about five years, and from maximum to minimum about six years. The fluctuation in latitude is called Spoerer's 'law of zones.' Regarding as determinant of the true period, not merely the total number of spots, but the number as affected by the law of zones, the true sun-spot cycle appears to be about fourteen years long, because a new zone breaks out in high latitudes while the old one still exists near the equator. Neither the cause underlying the law of zones, nor the reason for the spot period itself, is known. Probably the latter is due to the outbreak of exceptional eruptive forces held in check during seasons of few spots. A minimum occurred in 1901, and a maximum in 1905. Underlying the ordinary spot period is another cycle about 35 years in duration.

Do the Spots affect the Earth?—When sun spots are most numerous, displays of the aurora borealis are most frequent and brilliant, and the effects of magnetic storms are most strongly exhibited by fluctuations of magnetic needles

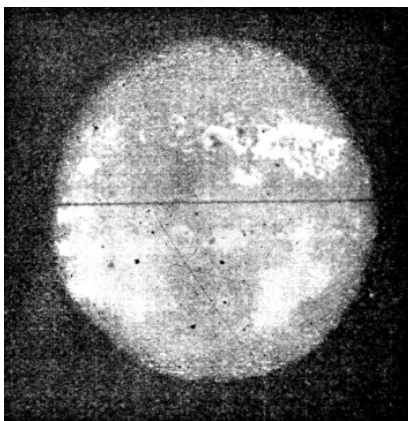

Zones of Invisible Faculae, 7th August, 1893
(photographed by Hale)

delicately mounted in observatories. Wolfer's diagram opposite shows how closely spot activity kept time with fluctuations of magnetic declination during the years 1886-96. Even in periods of largest and most numerous spots, the amount of heat received from the sun is not a thousandth part lessened, and any effect of periodicity of the spots upon the weather is too slight to be detected.

Faculae.—On the bright surface of the sun may nearly always be seen still brighter specks or streaks, many thousand miles in length, and

much larger than any of our continents. Such faculæ were discovered by Hevelius, at Danzig, about the middle of the 17th century. They are supposed to be elevated regions of the surface, crests of luminous matter protruding through the general and denser level of the photosphere. The faculæ are very numerous around the spots. The sun's atmosphere absorbs a large percentage of its own light, so that the illumination of the disk diminishes gradually toward the edge all around. On this account the faculæ are better seen near the edge; but they exist in belts all the way across the sun's disk, and can be so photographed at any time by the spectroheliograph (described in a later section), although they are invisible to ordinary vision. These invisible faculæ are most abundant in the sun-spot zones. There is evidence that some faculæ are clouds of incandescent calcium, an element strongly marked in the sun. The invisible faculæ appear to be related to the prominences projected against the photosphere.

The Sun's Rotation on his Axis.—The spots which last longest help most in ascertaining the time required by the sun in turning round once on his axis. A large number of observations have shown that a long-lived spot near the sun's equator, starting from the center, will pass from east to west all the way round and return to the center in $27\frac{1}{2}$ days. But as the earth will meanwhile have moved eastward also, the sun's period of rotation, as referred to the stars, is $25\frac{1}{4}$ days. This is the length of the true, or sidereal period. The exterior of the sun is not rigid, as the earth appears to be; and it is found that spots remote from the equator give a longer period of rotation the higher their latitude. At latitude 45° , the period of the sun's rotation is about two days longer than on the equator. At latitude 75° , the rotation period, as found by Dunér with the spectroscope, is $38\frac{1}{2}$ days. Also Young, Crew, and others have verified the rotation in this manner in the equatorial regions. The cause of acceleration at the equator has not yet been discovered.

The faculæ appear to have a different law of rotation from that governing the spots; for no matter what their latitude, they go round in less time than spots. From careful measures of numerous lines in the solar spectrum, Jewell has found that acceleration of the sun's equator is greatest for the higher or outer parts of the solar atmosphere, and that the difference between the rotation periods of the sun's outer and inner atmosphere amounts to several days.

The Spectroscope.—Place a prism in the path of a slender beam of sunlight. It will be refracted out of a straight course, and will emerge as a colored band. The light is all refracted, but it is not refracted equally; the red is bent least, and the violet most. The many-colored image produced in this manner is called a spectrum. This unequal refraction, and decomposition of white light into its primary colors is called dispersion. Upon it depend the principles of spectrum

analysis, which is a study of the nature and composition of luminous bodies by means of the light which they emit. Usually the spectroscope consists of four parts: (1) a very narrow slit S through which the beam of light is admitted, (2) a

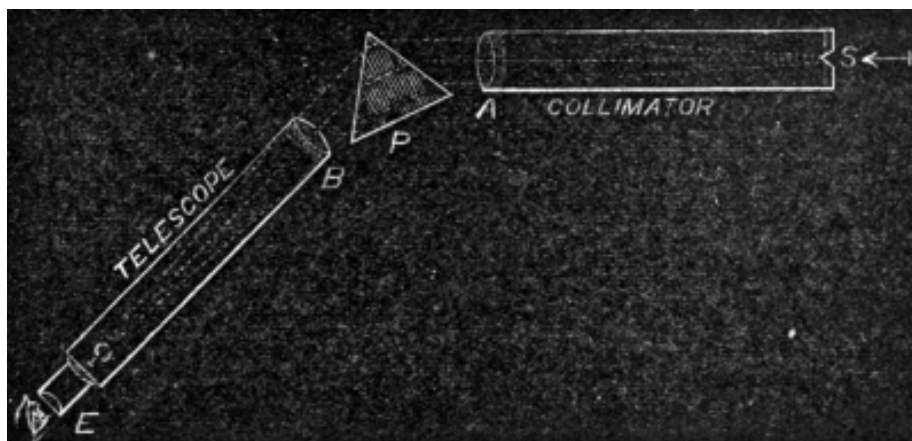
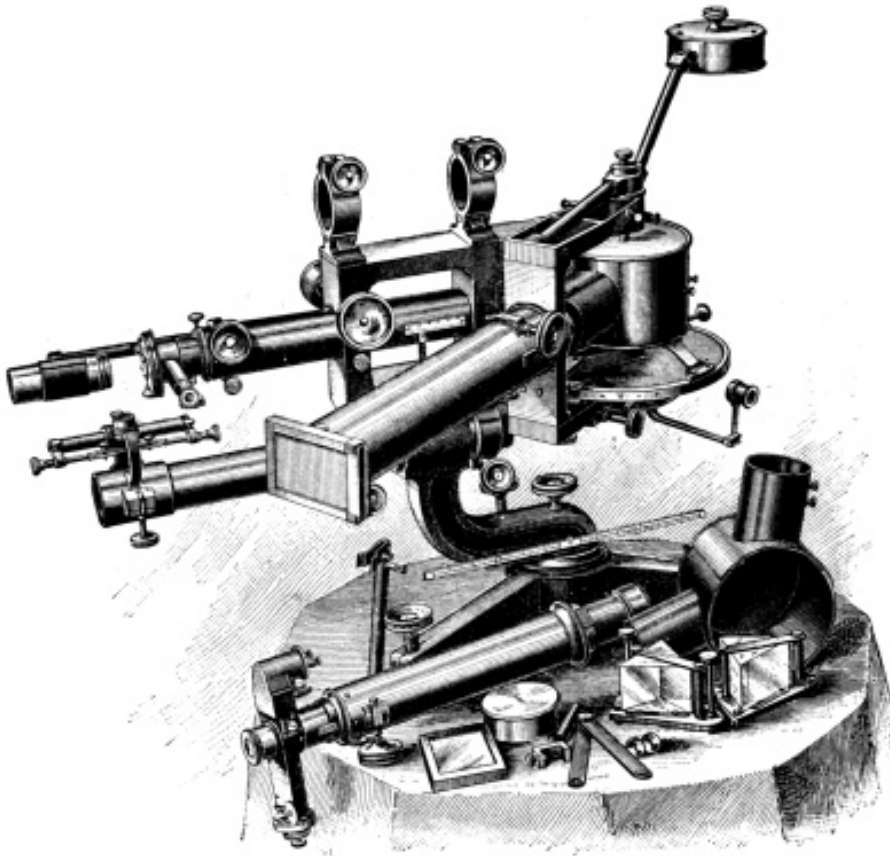

Illustration: A Single-prism Spectroscope in Outline

collimator, A , or small telescope at whose focus the slit is placed, (3) a prism, P , or a closely ruled surface, which effects the dispersion necessary to produce a spectrum, (4) a view telescope, BE , for studying optically the different regions of the spectrum. In researches of the present day, in which photography plays an important part, the spectroscope is usually constructed so that the eyepiece can be removed, and a plate-holder substituted in its place. Spectra can then be photographed, and afterward examined at leisure. The illustration on the next page shows a modern spectroscope as adapted for photographic work. Rays enter the upper tube on the left.

Continuous Spectrum and Fraunhofer Lines.—Place a candle before the slit, and a continuous spectrum is produced. A continuous spectrum is one which is crossed by neither bright nor dark lines; the colors from red to violet blend insensibly from one to the other in succession. Replace the candle by a beam of sunlight, and observe the difference: at first sight the spectrum appears to be continuous, but closer observation immediately shows that the band of color is crossed at right angles by a multitude of fine dark lines, of different widths and intensities, and seemingly without order of arrangement.

This spectrum is a discontinuous spectrum. The dark lines are called Fraunhofer lines, from Fraunhofer, who first made a chart of their position in the prismatic spectrum. He designated the more strongly marked lines by the first letters of the alphabet, the A line being in the red, and the H line in the violet. Their character and position in the spectrum are



Brashear's Universal Spectroscope (arranged for Photographic Research)

highly significant; for they indicate the chemical elements of which luminous bodies, especially the sun, are composed.

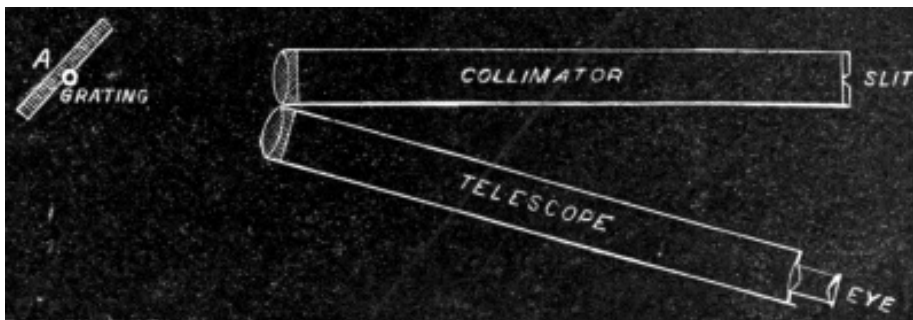

A Diffraction Spectroscope in Outline

Normal Solar Spectrum.—If the spectrum is formed by passing the

rays through a prism, as in the illustration, (page 240), relative position of the dark lines will vary with the substance composing the prism P ; the amount of dispersion in different parts of the spectrum varies with the material of the prism. Another method of producing the spectrum is therefore employed: by reflecting the sun's rays from a grating, A , accurately ruled with a diamond point upon polished speculum metal, thousands of lines to the inch, a diffraction spectrum is formed. In this case dispersion is entirely independent of the material of the grating; and the spectrum is called the *normal solar spectrum*, because the amount of dispersion of the rays is proportional to their wave length.

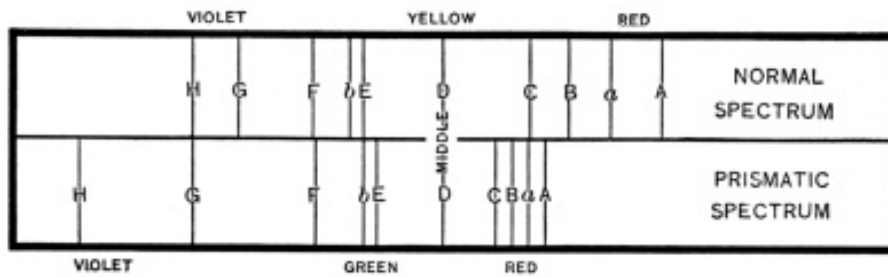

Normal and Prismatic Spectra of Equal Length (Middle of both Spectra at D)

The diagram gives a comparison of the two types of spectrum. The middle of the spectrum is practically coincident with the yellow D lines of sodium. As referred to the normal spectrum, the red end of a prismatic spectrum is very much compressed; and its violet end similarly expanded. The finest gratings are ruled with a dividing engine perfected by Rowland. The precision of its working is such that the number of parallel lines which can be ruled on a plate of metal an inch square exceeds 20,000; but one tenth this number is a good working limit.

High Power Spectroscopes.—The length of the spectrum varies with the degree of dispersion. It is evident that the greater the dispersion, the more the dark lines will be spread out lengthwise in the spectrum, and separated from each other. It is as if magnifying power were increased. Consequently the higher the dispersion, the greater the number of dark lines which can be seen and photographed.

When a greater degree of dispersion is required than one prism will produce, it is usual to employ an arrangement of many prisms, as shown in the figure. Light comes from the object glass of the collimator on the left, and passes round through several prisms successively, dispersion becoming greater and greater, as indicated by the gradually widening white band, which finally passes into the observing telescope on the right. When prisms and their accompanying small telescopes

are rigidly secured to the great tube in place of the eyepiece ordinarily used with it, such a combination of the two instruments is often called a telespectroscope. In the diffraction spectroscopy, increase of power is obtained by passing to the spectrum of a higher order, which is obtained by tilting the grating at an angle suitable to the order (second, third, or fourth) of spectrum desired. In all cases, the higher the degree of dispersion, the fainter becomes the spectrum in every part. So that a practical limit is soon reached.

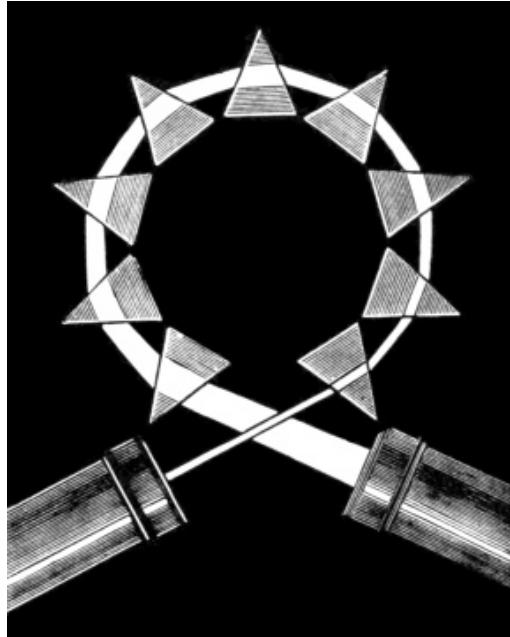

A High Power Prism Spectroscope

Principles of Spectrum Analysis.—In 1858 Kirchhoff reduced to the following compact and comprehensive form

the three principles underlying the theory of spectrum analysis: (1) Solid and liquid bodies, also gases under high pressure, give, when incandescent, a continuous spectrum. (2) Gases under low pressure give a discontinuous spectrum, crossed by bright lines whose number and position in the spectrum differ according to the substances vaporized. (3) When white light passes through a gas, this medium absorbs rays of identical wave length with those composing its own bright-line spectrum. Therefore dark lines or bands exactly replace the characteristic bright lines in the spectrum of the gas itself. This principle, theoretically correct, is easily illustrated and verified experimentally. These three fundamental principles fully account for the discontinuous spectrum of the sun, and the multitude of dark Fraunhofer lines which cross it.

Photographing the Sun's Spectrum.—The principles of spectrum analysis just enunciated indicate clearly how to ascertain the elements composing the sun. The process is one of mapping or photographing the lines in the solar spectrum, and alongside of it in succession the spectra of terrestrial elements whose existence in the sun is suspected. This is effected by means of the comparison prism, *ab*, shown above. It covers part of the slit, *m*. Sun's rays come from *B*, pass into the comparison prism, are totally reflected, and pass through the slit (downward in the adjacent figure). Thus they appear to come from *A*, the same

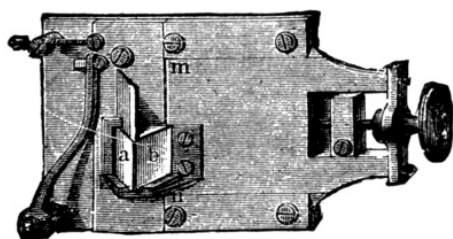

Slit and the Comparison Prism

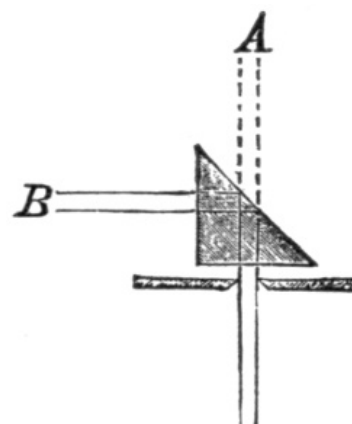

Course of Rays in Comparison Prism

as rays from the vaporized substance under examination; and as both sets of rays then make the optical circuit of the spectroscope side by side, the field of view embraces solar spectrum and spectrum of the terrestrial substance, also side by side. Direct comparison line for line is thereby greatly facilitated. Rowland of Baltimore and Higgs of Liverpool have achieved very marked success in photographing the sun's spectrum. The illustration on this page shows a very small part of that spectrum, known as the 'Great G group,' highly amplified, from a photograph by the latter. These lines are in the indigo. Many hundreds of the



Great G Group of Solar Spectrum (photographed by Higgs)

dark lines in the sun's spectrum are caused by absorption in our atmosphere. They are called telluric lines, and variation in their number and intensity affords an excellent method of finding the amount of aqueous vapor in the atmosphere, as Jewell and others have shown.

Elements already recognized in the Sun.—This process of comparison of the solar spectrum with spectra of terrestrial elements has been

carried so far that about 40 of these substances are now known to exist in the sun. Among them are (according to Rowland and others):—

(Al)	Aluminium	(H)	Hydrogen	(Ag)	Silver
(Cd)	Cadmium	(Fe)	Iron	(Na)	Sodium
(Ca)	Calcium	(Mg)	Magnesium	(Ti)	Titanium
(C)	Carbon	(Mn)	Manganese	(V)	Vanadium
(Cr)	Chromium	(Ni)	Nickel	(Y)	Yttrium
(Co)	Cobalt	(Sc)	Scandium	(Zn)	Zinc
(Cu)	Copper	(Si)	Silicon	(Zr)	Zirconium

The certainty with which an element is recognized depends upon two things: (*a*) the number of coincidences of spectral lines, (*b*) the intensity of the lines. Calcium ranks first in intensity, but iron has by far the greatest number of lines, with more than 2000 coincidences. All told, it may be said that iron, calcium, hydrogen, nickel, and sodium are the most strongly indicated. Runge has found certain evidence of oxygen in the sun. Chlorine and nitrogen, abundant elements on the earth, and gold, mercury, phosphorus, and sulphur are not indicated in the solar spectrum.

Sun-spot Spectrum.—If the spectrum of the sun itself is complicated, that of a spot is even more so. In it are multitudes of fine dark lines, indicating a greater degree of gaseous absorption than prevails on the sun generally.

A few of the Fraunhofer lines in the ordinary solar spectrum are not only deepened in intensity, but broadened out in the spot spectrum, as shown in the illustration. The dark belt running lengthwise through the middle is the spectrum of the umbra, and above and below it are spectra of both sides of the penumbra, much less dark. Thickening of the lines is most marked in the umbra, and gradually diminishes on both sides to the edges of the penumbra. Not infrequently these heavily thickened lines are pierced in the middle by a narrow bright line, called a ‘double reversal.’ Always this is true of the *H* and *K* bands in the spot spectrum. Spectra of many spots

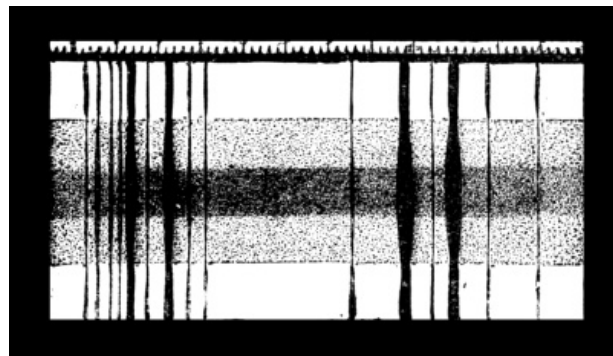

Thickened Lines of Spot Spectrum

strengthen the view that the spots are themselves depressions. Occasionally it happens that there is a violent motion, either toward or from us, of the gases

above a spot; this produces in the spectrum a marked distortion or branching of the dark lines. By measuring the amount and direction of this distortion, it can be calculated whether the gases were rushing toward or from us, and at what speed. On rare occasions these velocities have been as great as 200 or even 300 miles per second. The simple principle by which this is done is known as 'Doppler's principle.' It is explained on page 376.

The Bolometer.—With rise in its temperature, a metal becomes a poorer conductor of electricity; with loss of heat, it conducts electricity better. Iron at 300° below centigrade zero is nearly as perfect an electrical conductor as copper at ordinary temperatures. Upon the application of this important relation depends the principle of the bolometer. Its distinctive feature is a tiny strip of platinum leaf, looking much like a fine hair or coarse spiderweb. It is about $\frac{1}{4}$ inch long, $\frac{1}{500}$ inch broad, and so thin that a pile of 25,000 such strips would be only an inch high. This bolometer strip is connected into an electric circuit, and it is then carried slowly along the region of the infra-red spectrum, and kept parallel to the Fraunhofer lines. So sensitive is this instrument that the inconceivably slight change of temperature of only the one-millionth of a degree of the centigrade scale may be indicated.

Infra-red of the Solar Spectrum.—Beneath and beyond the red in the solar spectrum is an extensive region of dark bands wholly invisible to the human eye; nevertheless it has been photographed with certainty. But the actinic or chemical intensity is very feeble in this region, so that

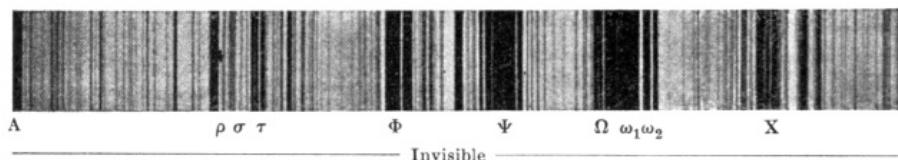

Invisible Heat Spectrum (photographed by Langley)

it is difficult to photograph directly. Langley, by means of an ingenious automatic process, in conjunction with his bolometer, or spectro-bolometer, has photographed the sun's heat spectrum in a form comparable with the normal spectrum. The above illustration represents its dark bands. The length of the invisible spectrum is extraordinary, being 10 times that of the sun's luminous spectrum, which would be represented on the same scale by a trifle more than the diameter of a lead pencil to the left of A.

Ultra-violet of the Solar Spectrum.—When we pass to higher regions of the sun's spectrum known as the violet, the light intensity is rapidly weakened, so that the lines become invisible to the eye. Photographs of this region can,

however, be taken, because the chemical intensity is great. In this manner, photographic maps of the invisible ultra-violet spectrum were made by Cornu, and their length is many times that of the visible spectrum. Just where the ultra-violet spectrum really ends is not known, as the farther region of it appears to terminate abruptly in consequence of absorption by the earth's atmosphere.

How to distinguish True Solar from Telluric Lines.—Dark lines in the solar spectrum being produced by absorption in our own atmosphere, as well as in that of the sun, it is important to have some method of distinguishing between them. One way is as follows, employing Doppler's principle. Arrange the spectroscopie so that sunlight may fall upon a small oscillating mirror, which reflects into the slit alternately rays from the east and the west limb. On account of the sun's rotation, the east limb is coming toward us; so the truly solar lines in its spectrum will be displaced toward the violet. Similarly, those of the west limb will lie toward the red, because that limb is going from us. As the mirror oscillates, Fraunhofer lines caused by solar absorption will themselves vibrate forth and back, as if the spectrum were being shaken; but dark lines due to absorption by our atmosphere will remain all the time immovable—a method due to Cornu.

Absorption by Solar Atmosphere.—Absorption by the sun's own atmosphere not only reduces the amount of sunlight received by the earth, but also changes its character. Langley has ascertained that if this atmosphere possessed no absorbing property, the sun would shine two or three times brighter than it now does, and with a bluish color resembling that of the electric arc light.

Project the sun's entire image on a screen, as if looking for spots; quite marked is the difference between the intensity of light at center of disk and at its edge. Try the experiment illustrated in Figure 11.24. Where the sun's image falls upon a screen, puncture it in two places, so that two pencils of sunlight may pass through and fall upon a second screen. As one of these comes from the edge of the solar disk, and the other from its center, their difference in intensity is rendered very obvious. It can be measured by a photometer. The sun's disk is only two fifths as bright close to the limb as at the center. This comparison relates only to rays by which we see in the red and yellow part of the spectrum. If a similar comparison is made for

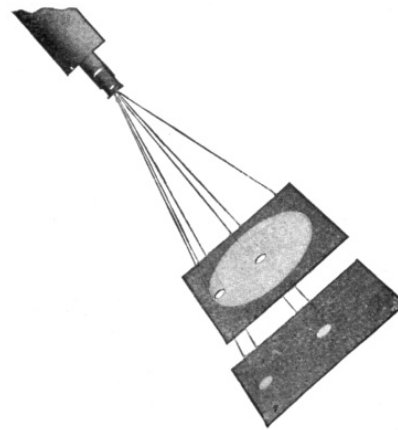

Solar Disk much brighter at the Center than near the Limb

blue and violet rays, by which the photographic plate is affected, absorption is very much greater; photographically, the light at the edge of the sun's disk is only one seventh as strong as at the center. This renders it difficult to photograph the entire sun with but a single exposure, so as to show an even disk; for if the exposure is short enough for the bright center, the image is very faint at the border.

The Chromosphere and Prominences.—Above and everywhere surrounding the sun's bright surface is a gaseous envelope, called the chromosphere. First seen during the total solar eclipses of 1605 and 1706 as an irregular rose-tinted fringe, analysis of the light shows that it is mainly composed of glowing hydrogen, although sodium, magnesium, and other metals are present. Depth of the chromosphere is not everywhere the same, and it varies between 5000 and 10,000 miles. Projected up through the chromosphere, but connected with it, are the fiery-red, cloud-shaped prominences or protuberances. It was first found that they are not lunar appendages, because the moon was seen to pass gradually over them during a total eclipse. Afterward the spectroscope verified this inference by showing that their light is due chiefly to incandescent hydrogen. Also there are the *H* and *K* lines, indicating vapor of calcium; and a bright yellow line, *D*₃, due to helium, an element not known on the earth till discovered in 1895 by Ramsay, but long known by its line to exist in the sun, whence its name. It is a very light gas obtained from a mineral called uraninite. The prominences are now photographed every clear day by means of the spectroheliograph. This ingenious instrument furnishes in a few seconds a complete picture of the prominences all the way round the sun's limb, which by the older methods of observing the protuberances piecemeal would require hours to make. Prominences cannot be observed by the telescope alone without the spectroscope, except during eclipses of the sun. They are most abundant over the sun's equator and the zones of greatest spottedness on either side of it; but while spots are never seen beyond latitude 45°, prominences have been observed in all latitudes, even up to the sun's poles. They are least numerous about latitude 65°.

The Spectroheliograph.—Young in 1870 was the first to photograph a solar prominence. No very decided success was attained until about 20 years afterwards, by the use of sensitive dry plates exposed in the spectroscope. By the addition of suitable accessory apparatus—mainly a second slit with the means of moving both slits automatically,—the spectroscope is converted into a spectroheliograph. This remarkable instrument, as devised and employed by Hale and built by Brashear, is depicted in the above illustration. A similar instrument with which almost identical results are obtained has been devised and used by

Deslandres, formerly of the Paris Observatory.

Classification of the Prominences.—The number, height, and variety of forms of prominences are very great. They are seen at every part of the sun's limb, being most abundant in an equatorial zone about 90° in breadth. Beyond latitude 45° north and south, there is a marked falling off to about 65° , followed by a renewed frequency in the region of both poles. The average height of the prominences is about 25,000 miles, or about three times the diameter of the earth. Occasionally prominences start up to a height exceeding 100,000 miles, as indicated on the colored plate at page 10; and the greatest heights ever observed were 300,000 and 350,000 miles, approaching half the sun's diameter. The latter was observed by Young, 7th October, 1880. Frequently protuberances are prominently developed at exactly opposite points on the sun's disk.

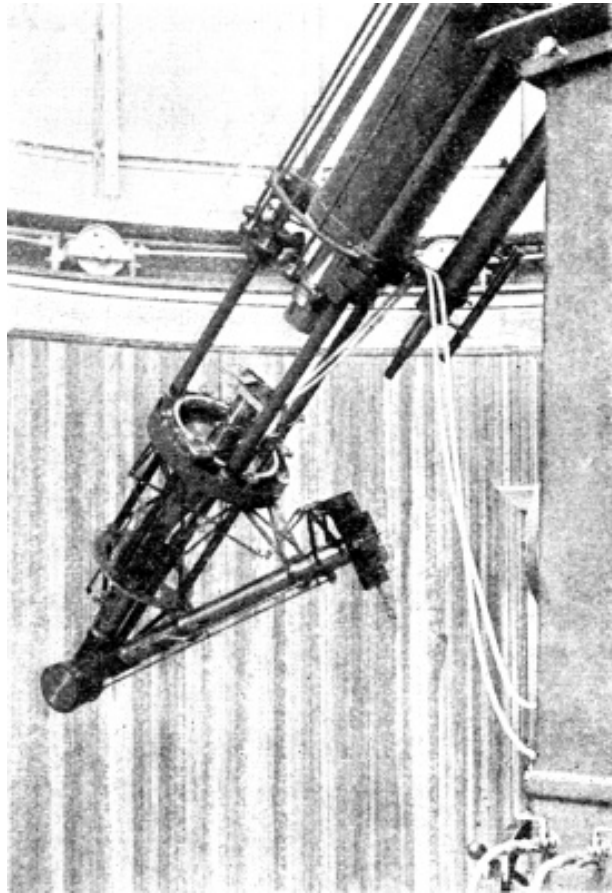

The Spectroheliograph (Hale)

As to form and structure, prominences are divided into two classes: eruptive or metallic, and cloud-like, quiescent prominences of hydrogen (see Figure 11.26). The former generally appear like brilliant jets, or separate filaments, varying rapidly in form and brightness. The spectrum of eruptive prominences shows the presence of a large number of metallic vapors. For the most part they are observed near the spot zones only, and never very near the poles of the sun. The velocity of detached filaments often exceeds 100 miles in a second of time, and on rare occasions it is four or five times as swift. Frequently prominences form exactly over spots. Quiescent ones are usually of enormous size laterally, and in appearance they are a close counterpart of terrestrial cirrus and stratus clouds.

Changes in them are not as a rule rapid, and near the sun's poles they have been known to last nearly a month without much change of form. Tacchini of Rome was a most persistent observer of prominences.

Calcium Flocculi.—By means of an improved and enlarged spectroheliograph attached to the Yerkes telescope (page 15), Professor Hale has secured the remarkable photograph shown on page 252, representing the calcium clouds, or *flocculi*, as he names them. They are revealed only in a spectroheliogram, being wholly invisible to direct observation or by means of ordinary photography. There are other types of flocculi due to hydrogen which are usually dark, and are found to have only a general resemblance in form to the bright calcium flocculi. Also iron flocculi have been obtained. It is apparent from the illustration that incandescent calcium is pretty evenly and very prominently distributed over the entire surface of the sun, network fashion, from pole to pole. This significant work is being continued at the Carnegie Solar Observatory in California.

The Envelopes of the Sun.—The interior of the sun is probably composed of gases, in a state quite unfamiliar to us, on account of intense heat and compression due to solar gravity. In consistency they may perhaps resemble tar or pitch. A series of layers, or shells, or atmospheres surround the main body of the sun. The illustration, Figure 11.28, has been conceived by Trouvelot to show the condition of things at the sun's surface and just beneath it. Although the view is a theoretical one, it has been made up from a reasonable interpretation of all the facts. Proceeding from the outside inward, we meet first the very thin shell called the chromosphere, probably about 5000 miles in thickness. Immediately underneath is the photosphere, made up of filaments due to the condensation of metallic vapors. The outer ends of these filaments form the granular structures which we see upon the sun generally, and their light shines through the chromosphere. Between them and the chromosphere is an envelope thinner still, not over 700 miles in thickness, and represented by the darker shaded upper side of the photosphere. It is called the reversing layer. In this gaseous envelope takes place that absorption which gives rise to the Fraunhofer lines. Where undisturbed by eruptions from beneath, the filaments of the photosphere are radial; but where such eruptions take place, producing under certain conditions the spots, these filaments are swept out of their normal vertical lines, as shown, forming the penumbra of the spot as seen from our point of view. From the outer surface of the body of the sun proper (which we never see) rise vapors of hydrogen and various metals of which the sun is composed. Numbers of these eruptive columns are shown. They are spread into masses of cloud-like forms composed of metallic vapors underneath

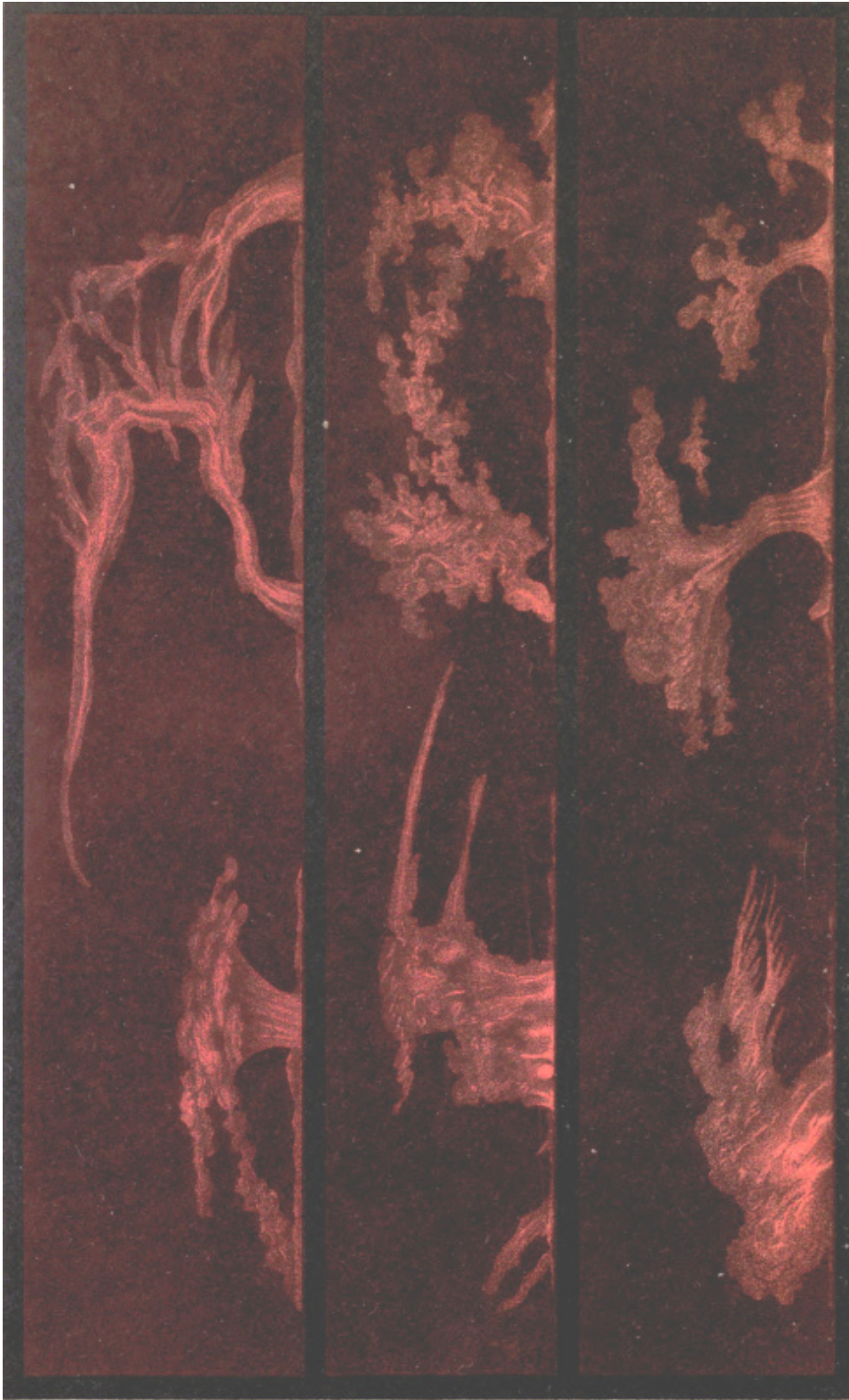

Solar Prominences (drawn by Trouvelot, from *Annals of Harvard College Observatory*)

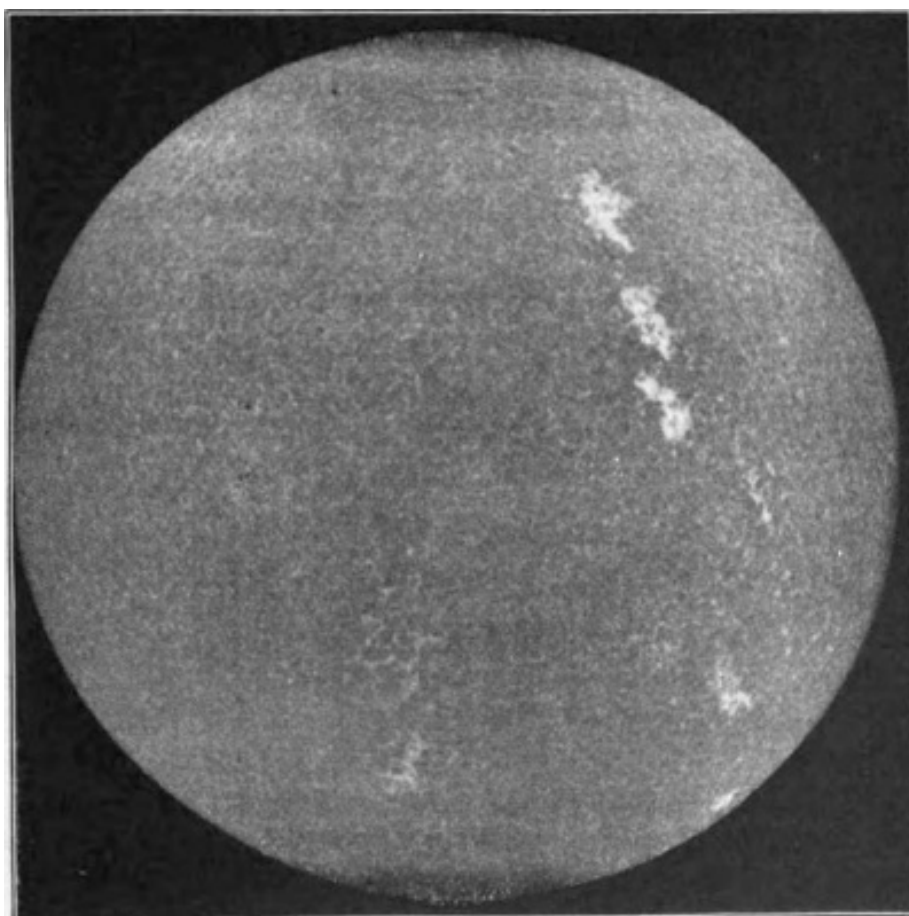

The Sun—Spectroheliogram of the Calcium Flocculi (1904)

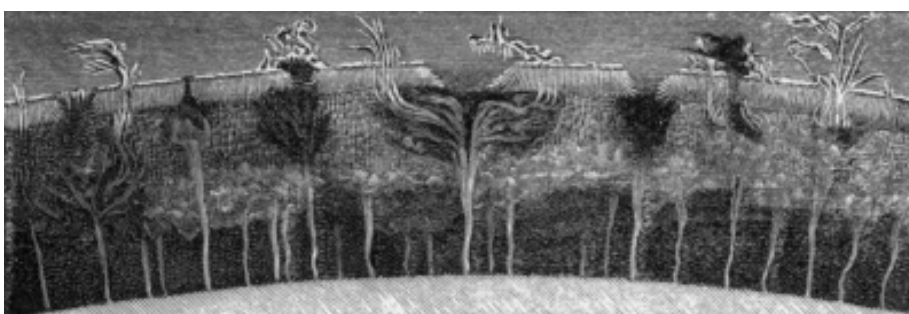

Atmosphere of the Sun in Ideal Section (from *Bulletin Astronomique*)

the photosphere. As these columns grow in number and stress becomes more and more intense, outbursts through the photospheric shell take place,

giving rise to phenomena known as sun spots and protuberances. Naturally such eruptions would be more violent at one time than at another, and we might expect them to occur periodically, just as we observe the spots actually do. Still above the chromosphere and prominences is the corona, not an atmosphere, properly speaking, but a luminous appendage of the sun (not shown in this illustration) whose light is of a complex character, and about which relatively little is known, because it can be seen only during total eclipses of the sun. Illustrations of it are given in the next chapter, with theories of its constitution.

Light and Brilliance of the Sun.—It is not easy to convey, in words or figures, any idea of the amount of light given out by the sun, since the figures expressed in ‘candle power,’ or in terms of the ordinary gas burner, or even the arc light, are so enormous as really to be beyond our comprehension. Indeed, any of these artificial illuminations, even the most brilliant electric light, if placed between the eye and the sun, seems black by comparison. The sun is nearly four times brighter than the brightest part of the electric arc. By an experiment at a steel works in Pennsylvania, Langley compared direct sunlight with the blinding stream of molten metal from a Bessemer converter; and although absolutely dazzling in its brightness, sunlight was found to be more than 5000 times brighter. The amount of light received from the sun is equal to that from 600,000 full moons.

The Sun’s Heat at the Earth.—Although difficult to give an idea of the sun’s light, much more so is it to convey an adequate notion of his enormous heat. So great is that heat, even at our vast distance from the sun, that it exceeds intelligible calculation. The unit of heat is called the calorie, and it signifies the amount of heat required to raise the temperature of a kilogram of water one degree of the centigrade scale. The number of calories received each minute upon a square meter of the earth’s surface has been repeatedly measured, and found to be 37, neglecting the considerable portion which is absorbed by our atmosphere. No variation in this amount has yet been detected; so that 37 calories per square meter per minute is termed the *solar constant*. With the sun in the zenith, his heat is powerful enough to melt annually a layer of ice on the earth nearly 200 feet in thickness. Or if we measure off a space five feet square, the energy of the sun’s rays, when falling vertically upon it, is equivalent to one horse power, or the work of about five men. Upon the deck of a steamer on tropical oceans there falls enough heat to propel it at about 10 knots, if only that heat could be fully utilized. Several attempts have been made to employ solar heat directly for industrial purposes, and Ericsson, the great Swedish engineer, and Mouchot built solar engines. The sun’s gaseous envelope, too, absorbs heat. Frost has shown that all parts of the disk radiate uniformly,

and that we should receive 1.7 times more heat, if the solar atmosphere were removed.

The Sun's Heat at the Sun.—The intensity of heat, like that of light, decreases as the square of the distance from the radiating body increases. Therefore, the amount of heat radiated by a given area of the sun's surface must be about 46,000 times greater than that received by an equal area at the distance of the earth.

One square meter of that surface radiates heat enough to generate more than 100,000 horse power, continuously, night and day. Imagine a solid cylinder of ice, nearly three miles in diameter and as long as the distance from the earth to the sun. The sun emits heat sufficient to melt this vast column in a single second of time; in eight seconds it would be converted into steam. Were the sun no farther from us than the moon, not only would his vast globe fill the entire sky, but his overpowering heat would vaporize the oceans, and speedily melt the solid earth itself. To investigate this inconceivable outlay of heat, to determine the laws of its radiation and its effects upon the earth, and to theorize upon the method by which this heat is maintained, are among the most important and practical problems of the astronomy of the present day. Whether the amount of heat given out by the sun is a constant quantity, or whether it varies from year to year or from century to century, is not yet determined. The temperature of the sun is very difficult to ascertain. Widely different estimates have been made. Probably 16,000° to 18,000° Fahrenheit is near the truth. But no artificial heat exceeds 4000° F.

How the Sun's Heat is maintained.—The sun's heat cannot be maintained by the combustion of carbon, for although the vast globe were solid anthracite, in less than 5000 years it would be burned to a cinder. Heat, we know, may result from sudden impact, as the collision of bodies. According to one theory, the sun's heat may be maintained by the impact of falling meteoric matter, and very probably this accounts for a small fraction; but in order that all the heat should be produced in this manner, an amount of matter equal to a hundredth part of the earth's mass would have to fall upon the sun each year from the present distance of the earth. This seems very unlikely. Only one possible explanation remains: if the sun is contracting upon himself, no matter how slowly, gases composing his volume must generate heat in the process. The eminent German physicist, von Helmholtz first proposed this theory of maintenance about 1850, and it is now universally accepted. So enormous is the sun that the actual shortening of his diameter (the only dimension we can measure) need take place but very slowly. In fact; a contraction of only six miles per century would fully account for all the heat given out by the sun. But six miles

would subtend an angle of only $\frac{1}{75}$ of a second of arc at the sun, and this is very near the limit of measurement with the most refined instruments. So it is evident that many centuries must elapse before observation can verify this theory.

The Past and Future of the Sun.—Accepting the theory that the sun's heat is maintained by gradual shrinkage of his volume, he must have been vastly larger in the remote past, and he will become very much reduced in size in the distant future. If we assume the rate of contraction to remain unchanged through indefinite ages, it is possible to calculate that the earth has been receiving heat from the sun about 20,000,000 years in the past; also, that in the next 5,000,000 years, he will have shrunk to one half his present diameter. For 5,000,000 years additional, he might continue to emit heat sufficient to maintain certain types of life on our earth. A vast period of 30,000,000 to 40,000,000 years, then, may be regarded as the likely duration, or life period, of the solar system, from origin to end. Their heat all lost by radiation, the sun and his family of planets might continue their journey through interstellar space as inert matter for additional and indefinite millions of years.

Chapter XII

Eclipses of Sun and Moon

In earliest ages, every natural event was a mystery. Day and night, summer and winter, and the most ordinary occurrences filled whole nations with wonder, and fantastic explanations were given of the simplest natural phenomena. But when anything happened so strange, and even frightful, as the total darkening of the sun in the daytime, it is scarcely matter for surprise that fear and superstition ran riot. Some nations believed that a vast monster was devouring the friendly sun, and barbarous noises were made to frighten him away. For ages the sun was an object of worship, and it was but natural that his darkening, apparently inexplicable, should have brought consternation to all beholders. Among uncivilized peoples, the ancient view regarding eclipses prevails to the present day.

Remarkable Ancient Eclipses.—The earliest mentioned solar eclipse took place in B.C. 776, and is recorded in the Chinese annals. During the next hundred years several eclipses were recorded on Assyrian tablets or monuments. On 28th May, B.C. 585, took place a total eclipse of the sun, said to have been predicted by Thales, which terminated a battle between the Medes and Lydians. This eclipse has helped to fix the chronology of this epoch. So, too, a like eclipse, 3d August, B.C. 431, has established the epoch of the first year of the Peloponnesian war; and the eclipse of 15th August, B.C. 310, is historically known as ‘the eclipse of Agathocles,’ because it took place the day after he had invaded the African territory of the Carthaginians, who had blockaded him in Syracuse: ‘the day turned into night, and the stars came out everywhere in the sky.’ Also a few solar eclipses are connected with events in Roman history. The first historic reference to the corona, or halo of silvery light which seems to encircle the dark eclipsing moon, occurs in Plutarch’s description of the total eclipse of 20th March, A.D. 71. Although it must have been frequently seen, there is no subsequent mention of it till near the end of the 16th century. The few eclipses recorded in this long interval have little value, scientific or otherwise, except as they have helped modern astronomers to ascertain the motion of the moon.

The Cause of Solar Eclipses.—Any opaque object interposed between the eye and the sun will cause a solar eclipse; and it will be total

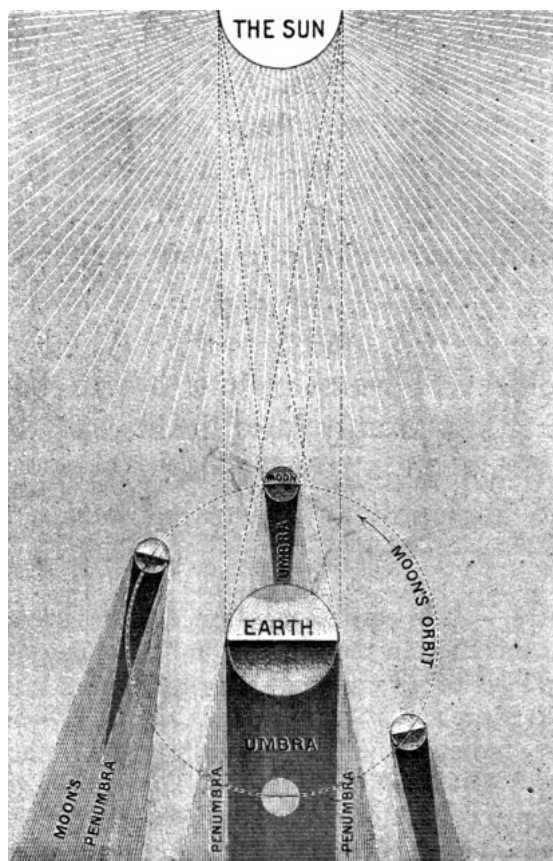

How Eclipses of Sun and Moon take Place

provided the angle filled by the object is at least as great as that which the sun itself subtends; that is, about one half a degree. Every one recognizes the shadow of the eagle flying over the highway, and the cloud's dark shadow moving slowly across the landscape, as produced by the interposition of a dark body between sun and earth. To the eager spectators on the towers of Notre Dame, Paris, 21st October, 1783, there appeared a novel sort of solar eclipse, caused by the drifting between them and the sun of the balloon in which were M. Pilâtre and the Marquis d'Arlandes. And just as when the eye is placed below the eagle, or behind the cloud, or beneath the balloon, an apparent but terrestrial eclipse of the sun is seen, just so when the moon comes round between earth and sun a real or astronomical eclipse of the sun takes place. But the great advantage of the latter comes from the fact that the moon, the eclipse-producing body, is very much farther away than cloud, and eagle, and balloon are,—beyond the atmosphere of the earth, at a distance relatively very great and comparable with that of the sun itself. It is a striking fact that the sun, about 400 times broader than the moon, happens to be about 400 times farther away, so that sun and moon both appear to be of nearly the same size in the heavens. A slight variation of our satellite's size or distance might have made that impressive phenomenon, the sun's total eclipse, forever impossible.

The Shadows of Heavenly Bodies.—As every earthly object, when in sunshine, casts a shadow of the same general shape as itself, so do the

every one recognizes the shadow of the eagle flying over the highway, and the cloud's dark shadow moving slowly across the landscape, as produced by the interposition of a dark body between sun and earth. To the eager spectators on the towers of Notre Dame, Paris, 21st October, 1783, there appeared a novel sort of solar eclipse, caused by the drifting between them and the sun of the balloon in which were M. Pilâtre and the Marquis d'Arlandes. And just as when the eye is placed below the eagle, or behind the cloud, or beneath the balloon, an apparent but terrestrial eclipse of the sun is

celestial bodies of our solar system. All these, whether planets or satellites, are spherical; and as they are smaller than the sun, it is evident that their shadows are long, narrow cones stretching into space and always away from that central luminary. Evidently, also, the length of such a shadow depends upon two things,—the size of the sphere casting it, and its distance from the sun. The average length of the shadow of the earth is 857,000 miles; of the moon, 232,000 miles. Each is at times about $\frac{1}{60}$ part longer or shorter than these mean values, because our distance from the sun varies $\frac{1}{60}$ part from the mean distance. So far away is the sun that the shadows of earth and moon are exceedingly long and slender. To represent them in their true proportions is impossible within the limits of a small page like this. In the illustration just given, however, attempt is made to give some idea of these slender shadows; but even there they are drawn five times too broad for their length. The shadow cast by a heavenly body is a cone, and is often called the umbra, or dense shadow, because the sun's light is wholly withdrawn from it. Completely surrounding the umbra is a less dense shadow, from which, as the figure on page 258 shows, the sun's light is only partly excluded. This is called the penumbra; and it is a hollow frustum of a cone, whose base is turned opposite to the base of the umbra. Both umbra and penumbra sweep through space with a velocity exceeding 2000 miles an hour; and they trail eastward across our globe. The way in which they strike its surface gives rise to different kinds of solar eclipse, known as partial, annular, and total.

True Proportions of Earth's and Moon's Orbits.—Even more difficult is it to represent the sizes and distances of sun, earth, and moon, in

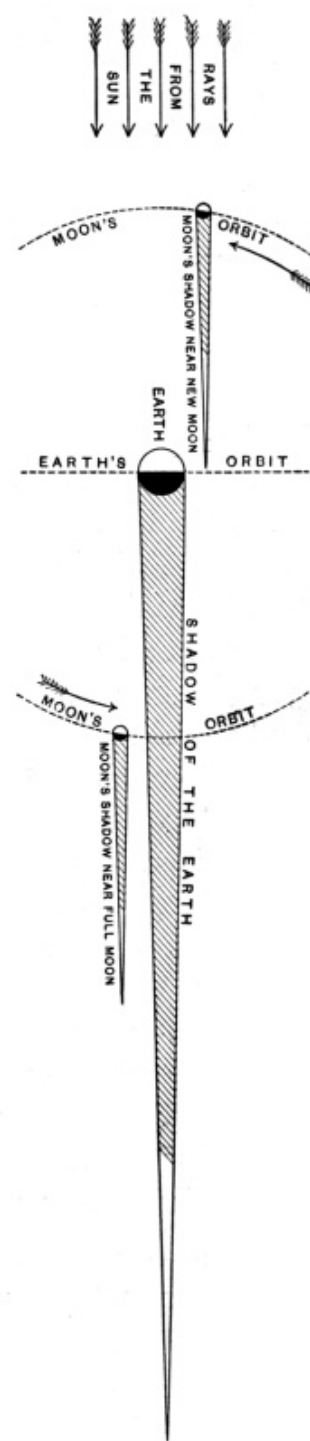

Slender Shadows of Earth and Moon

their true relative proportions on paper. It is easy, however, to exhibit them correctly in a medium-sized lot. Cut out a disk one foot in diameter to represent the sun. Pace off 107 feet from it, and there place an ordinary shot, $\frac{1}{10}$ inch in diameter, to represent the earth. At a distance of $3\frac{1}{3}$ inches from the shot, place a grain of sand, or a very small shot, to represent the moon. Then not only will the sizes of sun, earth, and moon, be exhibited in true proportion, but the dimensions of earth's and moon's orbits will be correctly indicated on the same scale. Every inch of this scale corresponds to 72,000 miles in space.



Sun not in Plane of Moon's
Orbit—Eclipses Impossible



Sun in Plane of Moon's
Orbit—Eclipses Inevitable

The Nodes of the Moon's Orbit.—Once every month—that is, every time the moon comes to the phase called new—there would be an eclipse of the sun, were it not that the moon's path about the earth, and that of the earth about the sun are not in the same plane, but inclined to each other by an angle of $5\frac{1}{7}^\circ$. When our satellite comes round to conjunction or new moon, she usually passes above or below the sun, which therefore suffers no eclipse. Two opposite points on the celestial sphere where the plane of moon's orbit crosses ecliptic are called the moon's nodes. Indeed, the term *ecliptic* had its origin from this condition: it is the plane near to which the moon must be in order that eclipses shall be possible.

The figures should make this clear. The sun is where the eye is, and the disk held at arm's length represents the lunar orbit, the earth being at its center. When held at the side, with the wrist bent forward, the moon's shadow falls far below the earth, and an eclipse is impossible. Now carry the disk slowly to the position of the second figure, gradually straightening out the wrist, and taking care to keep plane of disk always parallel to its first position: moon's orbit is now seen edge on, and when new moon occurs, an eclipse of the sun is inevitable.

Solar Ecliptic Limit.—As a solar eclipse cannot take place unless some part of the moon overlaps the sun's disk, it is clear that the apparent diameters of these two bodies must affect the distance of the sun from the moon's node, within which an eclipse is possible. This distance is called the solar ecliptic limit, and the figure illustrates it on both sides of the ascending node. From the new moon at the center to the farther new moon on either side is an arc of the ecliptic about 18° long. This is the value of the solar ecliptic limit. It is not a constant quantity, but is greatest when perigee and perihelion occur at the same time. As our satellite may reach the new-moon phase at any time within this limit, and may therefore eclipse the sun at any distance less than 18° from the moon's node, all degrees of solar eclipse are possible. They will range from the merest notch cut out of the sun's disk when he is remote from the node, to the central (annular or total) eclipse when he is very near the node.

Two Solar Eclipses Certain Every Year.—As the solar ecliptic limit is 18° on both sides of the moon's node, it is plain that an eclipse of the sun of greater or less magnitude is inevitable at each node, every year. For the entire arc of possible eclipse is about 36° , and the sun requires nearly 37 days to pass over it. If, therefore, new moon occurs just outside the limit west of the node (as on the right in the figure just given), in $29\frac{1}{2}$ days she will have made her entire circuit of the sky, and returned to the sun. An eclipse (partial) at this new moon is certain, because the sun can have advanced only a few degrees east of the node, and is well within the limit. One solar eclipse is therefore certain at each node every year.

If new moon falls just within the limit west of the node, two partial solar eclipses are certain at that node; also two are possible in like manner at the

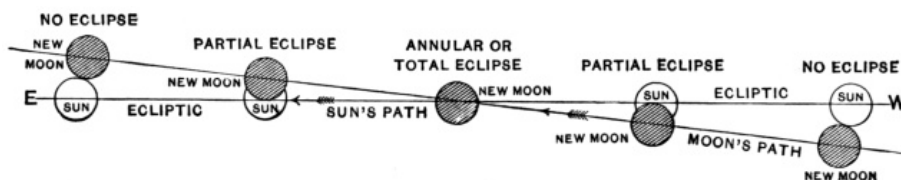

Solar Ecliptic Limit, both East and West of Moon's Ascending Node

opposite node. Even a fifth solar eclipse in a calendar year may take place in extreme cases. For if the sun passes a node about the middle of January, causing two eclipses then, two may also happen in midsummer; and the westward motion of the node makes the sun come again within the west limit in the month of December, with a possibility of a fifth solar eclipse before the calendar year is out. As two lunar eclipses also are certain in this period, the greatest possible number of eclipses in a year is seven. But this happens only once in about three centuries, the next occasion being the year 1935. The number of eclipses in a year is commonly four or five.

Partial Solar Eclipses.—When the moon comes almost between us and the sun, she cuts off only a part of the solar light, and a partial eclipse takes place.

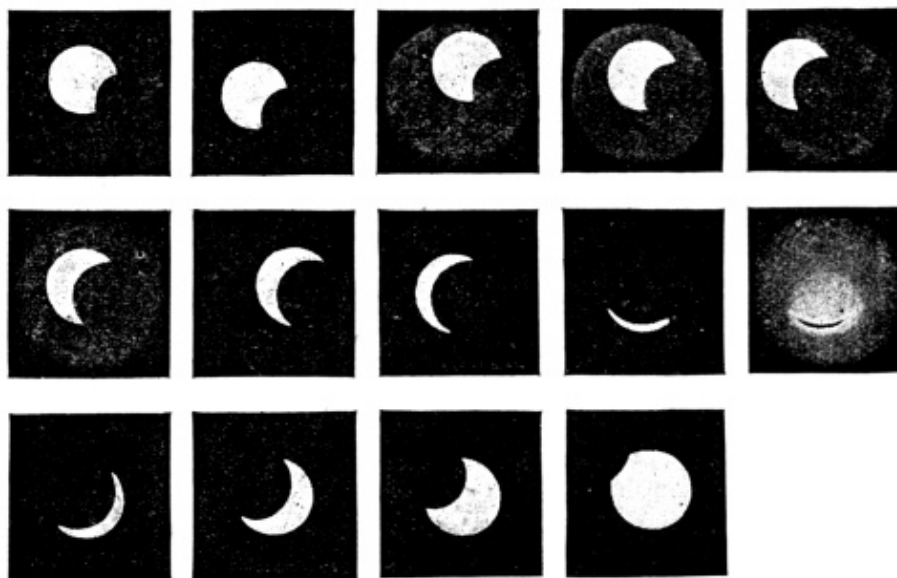

Solar Eclipse of 1887 (photographed in Tōkyō, Japan) *Exposure of the maximum phase immediately above was too long and the negative was solarized*

This happens when the sun is some distance removed from the node of the lunar orbit. Figure 12.6 shows several advancing and retreating stages of a partial eclipse. The degree of obscuration is often expressed by digits, a digit being the twelfth part of the sun's diameter. When there is a partial eclipse, it is only the moon's penumbra which strikes the earth, consequently the partial eclipse will be visible in greater or less degree from a large area of the earth's surface, perhaps 2000 miles in breadth, if measured at right angles to the shadow, but often double that width on the curving surface of our globe. This will be near

the north pole or the south pole according as the center of the moon passes to the north or south of the center of the sun. About 90 partial eclipses of the sun occur in a century.

Annular Eclipses.—If the sun is very near the moon's node when our satellite becomes new, clearly the moon must then pass almost exactly between earth and sun. If at the same time she is in apogee, her apparent size is a little less than that of the sun. Then her conical shadow does not quite reach the surface of the earth, and a ring of sunlight is left, surrounding the dark moon completely. This is called an annular eclipse because of the annulus, or bright ring of sunlight still left shining.

Its greatest possible breadth is about $\frac{1}{20}$ the sun's apparent diameter. This ring may last nearly $12\frac{1}{2}$ minutes under the most favorable circumstances, though its average duration is about one third of that interval. The illustration shows the ring at five different phases. Nearly 90 annular eclipses of the sun take place every century. These phenomena are now recognized to be of exceptional value, that of 10th November, 1901, having added appreciably to our knowledge of the reversing layer (page 265). Only two annular eclipses visit the United States during the rest of the twentieth century: 7th April, 1940, and 10th May, 1994.



Annular Eclipse

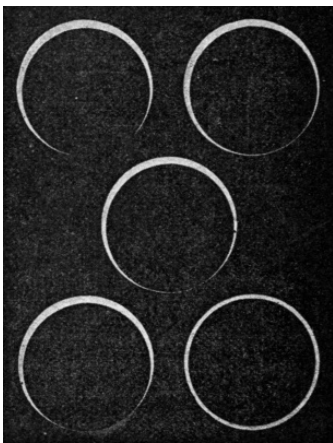

Phases of the Annulus (reduced from a Daguerreotype by Alexander)

Total Solar Eclipses.—Most impressive and important of all obscurations of heavenly bodies is a total eclipse of the sun. It takes place when the lunar shadow actually reaches the earth as in the illustration. While the moon passes eastward, approaching gradually the point where she is exactly between us and the sun, steadily the darkness deepens for over an hour, as more and more sunlight is withdrawn. Then quite suddenly the darkness of late twilight comes on, when the moon reaches just the point where she first shuts off completely the light of the sun. At that instant, the solar corona flashes out, and the total eclipse begins. The observer is then inside the

umbra, and totality lasts only so long as he remains within it. Total eclipses are sometimes so dark that observers need artificial light in making their records. In consequence of the motion of the moon, the tip

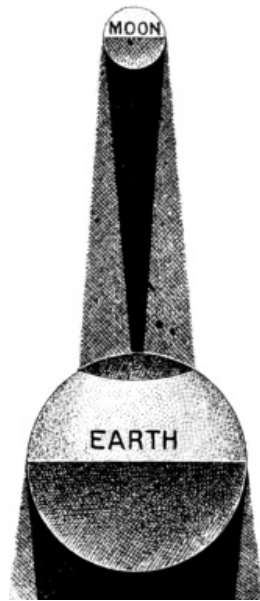

Total Eclipse

of the lunar shadow, or umbra, makes a path or trail across the earth, and its average breadth is about 90 miles. The earth by its rotation is carrying the observer eastward in the same direction that the shadow is going. If he is within the tropics, his own velocity is nearly half as great as that of the shadow, so that it sweeps over him at cannon-ball speed, never less than 1000 miles an hour. As an average, the umbra will require less than three minutes to pass by any one place, but the extreme length of a total solar eclipse is very nearly eight minutes. Few have, however, been observed to exceed five minutes in duration; and no eclipses closely approaching the maximum duration occur during the next $2\frac{1}{2}$ centuries. Total eclipses occurring near the middle of the year are longest, if at the same time the moon is near perigee, and their paths fall within the tropics. Always after total eclipse is over, the partial phase begins again, growing smaller and smaller and the sun getting continually brighter, until last contact when full sunlight has returned. Nearly 70 total eclipses of the sun take place every century.

the atmosphere is saturate with aqueous vapor, weird color effects ensue, by no means overdrawn in the frontispiece.

The Four Contacts.—As the moon by her motion eastward overtakes the sun, an eclipse of the sun always begins on the west side of the solar disk. First contact occurs just before the dark moon is seen to begin overlapping the sun's edge or limb. Theoretically the absolute first contact can never be observed; because the instant of true contact has passed, a fraction of a second before the moon's edge can be seen. First contact marks the beginning of partial eclipse. If the eclipse is total or annular, a long partial eclipse precedes the total or annular phase. At the instant this partial eclipse ends, the total or annular eclipse begins; and this is the time when second contact occurs. Usually second contact will follow first contact by a little more than an hour. If the eclipse is total, second contact takes place on the east side of the sun; if annular, on the west side. Following second contact, by a very few moments at the most, comes third contact: in the total eclipse, it occurs at the sun's west limb; in the annular eclipse, at the east limb. Students should represent the contacts by a diagram.

Then from third contact to last contact is a partial eclipse, again a little more than an hour in duration—the counterpart of the partial eclipse between first and second contacts. Fourth or last contact takes place at the instant when the moon's dark body is just leaving the sun, and the interval between first and fourth contacts is usually about 3 hours. If the eclipse is but partial, only two contacts, first and last, are possible.

Young's Reversing Layer.—According to the principles of spectrum analysis, a gas under low pressure gives a discontinuous spectrum composed of characteristic bright lines. As the dark lines of the solar spectrum are produced by absorption in passing through the atmosphere of the sun, it occurred to Young that a total eclipse afforded an opportunity to observe the bright-line spectrum of this atmosphere by itself. Following is his description of this phenomenon, as seen for the first time in Spain, during the total eclipse of 1870:—

‘As the moon advances, making narrower and narrower the remaining sickle of the solar disk, the dark lines of the spectrum for the most part remain sensibly unchanged. . . . But the moment the sun is hidden, through the whole length of the spectrum, in the red, the green, the violet, the bright lines flash out by hundreds and thousands, almost startlingly; as suddenly as stars from a bursting rocket head, and as evanescent, for the whole thing is over within two or three seconds. The layer seems to be only something under a thousand miles in thickness.’ A like observation has been made on several occasions, and during the eclipse of 1896 and later eclipses the bright lines have been successfully photographed. This stratum of the solar atmosphere, known as Young's reversing layer, is probably about 700 miles in thickness.

The Solar Corona.—The corona is a luminous radiance seen to surround the sun during total eclipses. The strong illumination of our atmosphere precludes our seeing it at all other times. The corona, as observed with the telescope, is composed of a multitude of streamers or filaments, often sharply defined, and sometimes stretching out into space from the disk of the sun millions of miles in length. For the most part these streamers are not arranged radially, and often the space between them is dark, close down to the disk itself. The general light of the corona averages about three times that of the full moon; but the amount of this light varies from one eclipse to another, just as the form and dimensions of the streamers do. The coronal light, very intense close to the sun, diminishes rapidly outward from the disk, so that the object is a very difficult one to photograph distinctly in every part on a single plate. The corona appears to be at least triple; there are polar rays nearly straight, inner equatorial rays sharply curved, and often outer equatorial streamers, perhaps connected in origin with the

zodiacal light. The last are not visible at every eclipse, and they were first successfully photographed in India during the total eclipse of 1898. Recent photographs of the corona show no variation in form from hour to hour. As yet no theory of this marvelous object explains the phenomena satisfactorily. Neither a magnetic theory advanced by Bigelow, nor a mechanical one by Schaeberle, has successfully predicted its general form. The brighter filaments may be due to electric discharges. Total eclipses permit only a few hours' advantageous study of the corona, in a century.

The Spectrum of the Corona.—Our slight knowledge of the corona is for the most part based on evidence furnished by the spectroscope.

Its light gives a faint continuous spectrum, showing incandescent liquid or solid matter; and a superposed spectrum of numerous bright lines indicating luminous gases, among them hydrogen. Also, in the violet and ultra-violet

are numerous bright lines. But the characteristic line of the coronal spectrum is a bright double one in the green, often called the '1474 line,' erroneously, and now known as 5303.7. Calcium and helium are not present. The bright lines are mainly due to a supposed element called 'coronium' existing in a gaseous form in the corona, only recently recognized on the earth. Also there are dark lines, indicating much reflected sunlight, possibly coming from meteoric matter surrounding the sun. Deslandres, by photographing on a single plate the spectrum of the corona on opposite sides of the sun, obtained a displace-

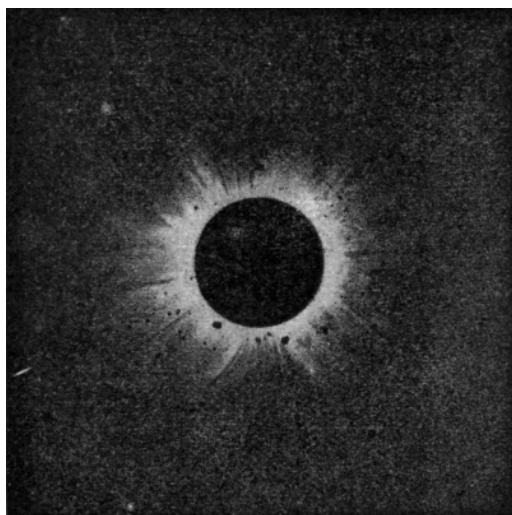

Corona of 1871 (Lord Lindsay)

ment of its bright line, showing that eastern filaments are approaching the earth, and western receding from it; and the calculated velocities indicate that the corona revolves with the sun. Independent proof of the solar origin of the corona is thus afforded.

Periodicity of the Corona.—At no two eclipses of the sun is the corona alike. How rapidly it varies is not yet found out, but observations of the total eclipse of 1893 showed that the corona was exactly the same in Africa as when photographed in Chile $2\frac{1}{2}$ hours earlier. Slow periodic variations are known to take place, seeming to follow the 11-year cycle of the spots on the sun. At the time of maximum spots, the corona is made up of

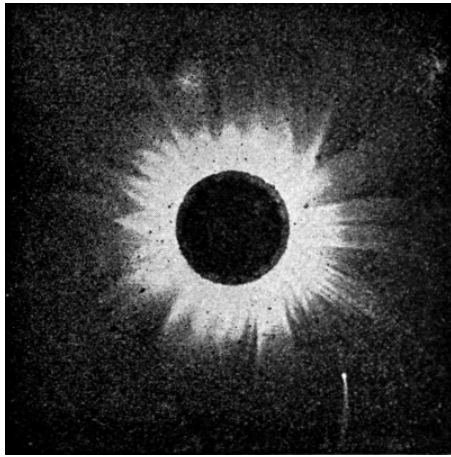

Corona of 1882 (Schuster and Wesley)

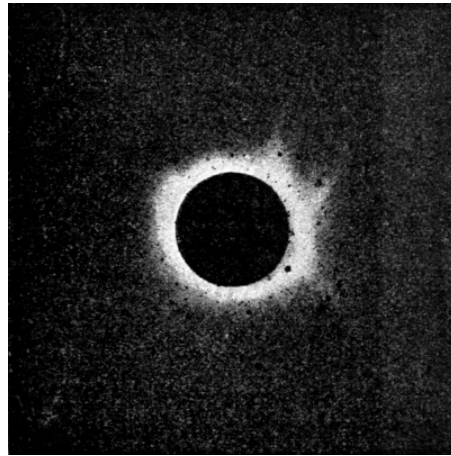

Corona of 1893 (Deslandres)

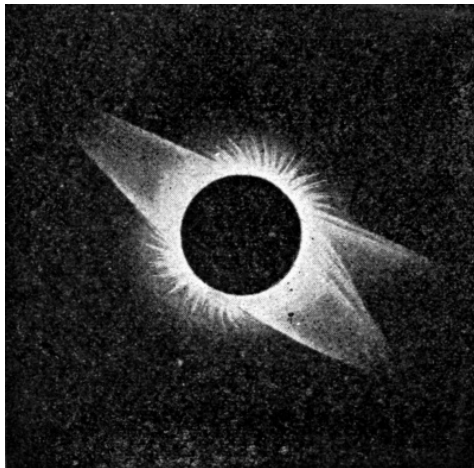

Corona of 1878 (Harkness)

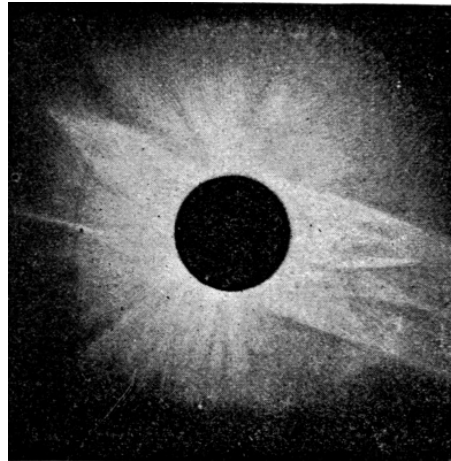

Corona of 1889 (Pritchett)

an abundance of short, bright, and interwoven streamers, rather fully developed all around the sun, as in these three photographs (India 1871, Egypt 1882, and Africa 1893). At or near the sun-spot minimum, on the other hand, the corona is unevenly developed: there are beautiful, short, tufted streamers around the solar poles, and outward along the ecliptic extend the streamers, millions of miles in length, as pictured in the photographs of total eclipses in the United States in 1878 and 1889. A similar form was repeated in the eclipse of 1900, so the cycle is established; but no sufficient explanation of this periodicity of the corona has yet been given.

Important Modern Eclipses of the Sun.—Not until the European eclipse of 1842 did the true significance of circumsolar phenomena begin to be appreciated. In the eclipses of 1851 and 1860 it was proved that prominences and corona belong to the sun, and not to the moon. Just after the eclipse of 1868 (India) was made the important discovery that prominences can be observed at any time without an eclipse by means of the spectroscope. In 1869 (United States), bright lines were found in the spectrum of the corona, one line in the green showing the presence of an element not then known on the earth, and hence called *coronium*. In 1870 (Spain), the reversing layer was discovered, and in 1878 (United States), a vast extension of the coronal streamers about 11 million miles both east and west of the sun (shown above only in part). In 1882 (Egypt), the spectrum of the corona was first photographed; and in 1889 (California), fine detail photographs of the corona were obtained. In 1893 (Africa), it was shown that the corona probably rotates bodily with the sun; in 1896 (Nova Zembla), actual spectrum photographs of the reversing layer established its existence conclusively; and in 1898 (India), the long ecliptic streamers of the corona were for the first time successfully photographed. In 1900 (the southern United States, Spain, Algiers, and Tripoli) periodicity in the form of the corona for the epoch of minimum spots was definitely ascertained; in 1901 (Mauritius, Sumatra, and Singkep), the new gases argon, neon, krypton, and xenon were revealed in the sun's chromosphere; and in 1905 (Spain, Tunis, Tripoli, and Egypt), periodicity in the form of the corona for the epoch of maximum spots was finally established. Numerous observations have been made tending to show that certain streamers of the corona are intimately associated with adjacent sunspots and prominences; also that other streamers seem to partake in part of the nature of electric discharges.

Observations during Total Eclipses.—Observations of importance at future eclipses are as follows, in large part photographic:—

1. Contacts and photographs for correcting the tables of the moon's motion.
2. Spectrum of the 'flash' at the beginning and end of totality.
3. Spectrum of the corona in different regions near the moon's limb—for its rotation and constitution.
4. Photographs of the corona, with varied exposure in different parts—correctly timed, if possible, at all distances from the moon's limb.
5. Polarization and photometry of the corona.
6. Measurement of its heat radiations with the bolometer.
7. Observations of the shadow bands, just before, after, and during totality.
8. Electrical conditions of the air.
9. Terrestrial magnetic currents.
10. Temperature, barometric pressure, and direction of the wind.

Important Future Eclipses.—Total eclipses of the sun in the coming quarter century are for the most part visible in foreign lands. The paths of very few cross the United States. Following are dates of important eclipses, regions of general visibility, and approximate duration of the total phase:—

		min.
1907, January 14	Turkestan and Mongolia	2
1912, October 10	Ecuador and Brazil	2
1914, August 21	Norway, Sweden, and Russia	2
1916, February 3	Colombia and Guadeloupe	3
1918, June 8	Oregon to Florida	2
1919, May 29	Brazil, Liberia, and Congo	7
1922, September 21	West Australia and Queensland	6
1923, September 10	Lower California and Mexico	4
1925, January 24	Duluth to New Haven, Conn.	2
1926, January 14	Sumatra and Borneo	4
1927, June 29	England, Norway, and Lapland	1
1929, May 9	Sumatra and the Philippines	5
1932, August 31	James Bay, Quebec, and Maine	2

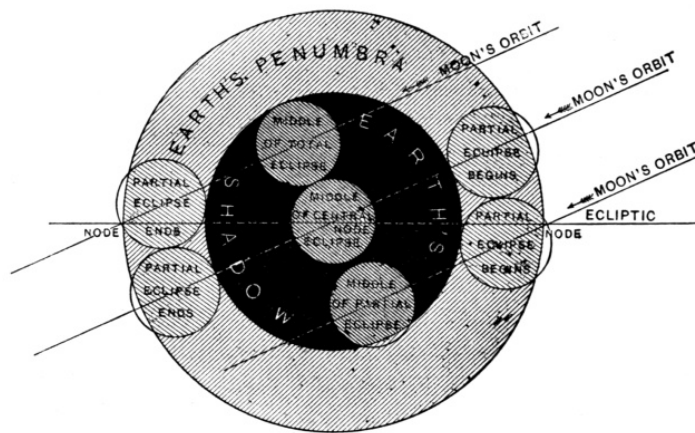

Earth's Shadow and Penumbra in Section

Exact times and circumstances of all these eclipses are regularly published in the Nautical Almanacs, issued by the English, German, French, and American governments (p. 147). The great total eclipses of 1955 (Luzon) and 1973 (Sahara) will be $7\frac{1}{2}$ minutes in duration, the longest for a thousand years.

Eclipses of the Moon.—As all dark celestial bodies cast long, conical shadows in space, any non-luminous body passing into the shadow of

another is necessarily darkened or eclipsed thereby. When, in her journey round our earth, the moon comes exactly opposite the sun, or nearly so, she passes through our shadow. Then a lunar eclipse takes place. Refer to

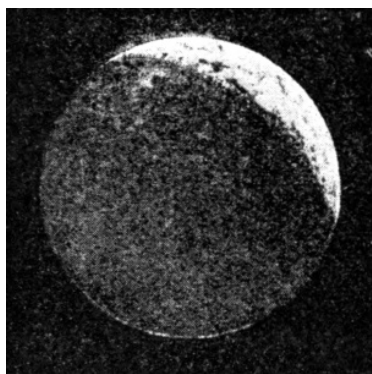

Lunar Eclipse of $10\frac{1}{2}$ Digits

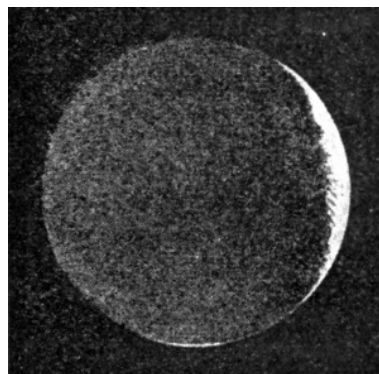

Lunar Eclipse one Digit short of
Totality

illustrations given on pages 258 and 259: clearly, a lunar eclipse can happen only when the moon is full, or at opposition. There is not an eclipse of the moon every month, because unless she is near the plane of the ecliptic, that is, near her node at the time, she will pass above or below the earth's shadow. There are partial eclipses of the moon as well as of the sun; but in this case the eclipse is partial because the moon passes only through the edge of our shadow (lower orbit in the illustration opposite), and so is not wholly darkened. The eclipse may be total, however (upper of the three orbits), without our satellite passing directly through the center of the earth's shadow, because that shadow, where the moon passes through it, is nearly three times the moon's own diameter. A lunar eclipse is always visible to that entire hemisphere of our globe turned moonward at the time. The total phase lasts nearly two hours, and the whole eclipse often exceeds three hours in duration.

The magnitude of a lunar eclipse is often expressed by digits, that is, the number of twelfths of the moon's diameter which are within the earth's umbra. The last illustrations show different magnitudes of lunar eclipse; note the roughness of the terminator. Also the same thing may be expressed decimally, an eclipse whose magnitude is 1.0 occurring when the moon enters the dark shadow for a moment, and at once begins to emerge.

Diameter of the Earth's Shadow.—As the mean distance of our satellite is 239,000 miles, the earth's shadow must extend into space beyond the moon a distance equal to the moon's distance subtracted from the length of the shadow, or 618,000 miles. The diameter of the earth's shadow where the moon traverses

it during a lunar eclipse may, therefore, be found from the proportion

$$857,000 : 7900 :: 618,000 : x.$$

This gives 5700 miles, or $2\frac{2}{3}$ times the moon's diameter. As our satellite moves over her own diameter in about an hour, a central eclipse may last about four hours, from the time the moon first begins to enter shadow to the time of complete emersion from it.

Lunar Ecliptic Limit.—As our satellite revolves round us in a plane inclined to the ecliptic, it is evident that there must be a great variety of conditions

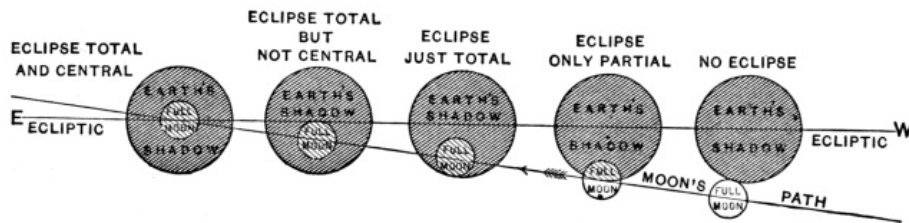

Lunar Ecliptic Limit West of Moon's Ascending Node

under which eclipses of the moon take place. All depends upon the distance of the center of the earth's shadow from the node of the moon's orbit at the time of full moon. The illustration helps to make this point plain. It shows a range in magnitude of eclipse, from the total and central obscuration (on the left), to the circumstances which just fail to produce an eclipse (on the right). The arc of the ecliptic, about 12° long, included between these two extremes, is called the lunar ecliptic limit. It varies in length with our distance from the sun; evidently the farther we are from the sun, the larger will be the diameter of the earth's shadow. Also the lunar ecliptic limit varies with the moon's distance from us; because the nearer she is to us, the greater the breadth of our shadow which she must traverse. Inside of this limit, the moon may come to the full at any distance whatever from the nodes. Clearly there is a limit of equal length to the east of the node also; and the entire range along the ecliptic within which a lunar eclipse is possible is nearly 25° . As the sun (and consequently the earth's shadow) consumes about 26 days in traversing this arc, there is an interval of nearly a month at each node, or twice a year, during which a lunar eclipse is possible.

The Moon still Visible although Eclipsed.—Usually the moon, although in the middle of the earth's shadow where she can receive no direct



Total Lunar Eclipse, 3d
September, 1895
(photographed by
Barnard)

light from the sun, is nevertheless visible because of a faint, reddish brown illumination. Probably this is due to light refracted through the earth's atmosphere all around the sunrise and sunset line. Atmosphere absorbs nearly all the bluish rays, allowing the reddish ones to pass quite freely.

Naturally, if this belt of atmosphere were perfectly clear, the darkened portion of the moon might be plainly visible as in the picture of the eclipse of 1895 (page 273), while if it were nearly filled with cloud, very little light could pass through and fall upon the moon; so that when she had reached the middle of the shadow, she would totally disappear. Accordingly there are all variations of the moon's visibility when totally eclipsed; in 1848, so bright was it that some doubted whether there really was an eclipse; while in 1884 the coppery disk of the moon disappeared so completely that she could scarcely be seen with the telescope. In September 1895 the moon, even when near

the middle of our shadow, gave light enough to enable Barnard to obtain this photograph of the total eclipse, by making a long exposure, which accounts for the stars being trails instead of mere dots; for the clockwork was made to follow the moving moon. Total lunar eclipses are of use to the astronomer in measuring the variation of heat radiated at different phases of the eclipse. Also the occultations of faint stars can be accurately observed, as the moon's disk passes over them; and by combining a large number of these observations at widely different parts of the earth, the moon's size and distance can be more precisely ascertained. The total eclipses of our satellite in 1888, 1895, and 1898 were successfully utilized in this manner. By consulting the almanac, the times of the phases of lunar eclipses can be ascertained; also the regions of the globe where they may be visible. But these phenomena cannot be observed very accurately, because the earth's penumbra is never sharply defined on the moon.

Relative Frequency of Solar and Lunar Eclipses.—Draw lines tangent to sun and earth, as in next figure. An eclipse of the moon takes place whenever our satellite, near M' , passes into the dark shadow cone. On the other hand, when near M , a solar eclipse happens if the moon touches any part of the earth's shadow cone extended sunward from E . As the breadth of this shadow cone is greater at M than at M' , obviously the moon must pass within it more often at M ; that is, eclipses of

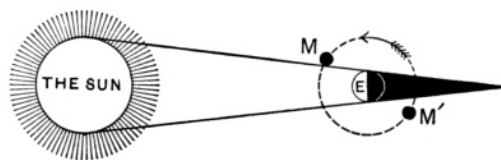

More Solar than Lunar Eclipses



Lunar Eclipse just before Totality, observed at Amherst College, 10th March, 1895

the sun are more frequent than eclipses of the moon. Calculation shows that the relative frequency is about as 4 to 3. This means simply with reference to the earth as a whole. If, however, we compare the relative frequency of solar and lunar eclipses visible in a given country, it will be found that lunar eclipses are much more often seen than solar ones. This is because some phase of every lunar eclipse is visible from more than half of our globe, while a solar eclipse can be seen from only that limited part of the earth's surface which is traversed by the moon's umbra and penumbra. If we consider the narrow trail of the umbra alone, a total solar eclipse will be visible from a given place only once on the average in 350 years.

Eclipse Seasons.—It has been shown that eclipses of sun and moon can happen only when the sun is near the moon's node. Were these points stationary, it is clear that eclipses would always take place near the same time every year. But the westward motion of the nodes is such that they travel completely round the ecliptic in $18\frac{2}{3}$ years. The sun, then, does not have to go all the way round the sky in order to return to a node; and the interval elapsing between two consecutive passages of the same node is only $346\frac{2}{3}$ days. This is called the eclipse year. Eclipses at a given node, then, happen nearly three weeks earlier each calendar year. The midyear eclipses of 1899 took place in June, of 1900 and 1901 in May. Each passage of a node marks the middle of a period during which

the sun is traveling over an arc equal to double the ecliptic limit. No eclipse can happen except at these times. They are, therefore, called *eclipse seasons*. As the solar ecliptic limit exceeds the lunar, so the season for eclipses of the sun exceeds that for lunar eclipses: the average duration of the former is 37 days, and of the latter 23.

Recurrence and the Saros.—Ever since the remote age of the Chaldeans, B.C. 700, has been known a period called the saros, by which the return of eclipses can be roughly predicted. The length of the saros is $6585\frac{1}{3}$ days, or 18 years $11\frac{1}{3}$ days. At the end of this period, the centers of sun and moon return very nearly to their relative positions at the beginning of the cycle; also certain technical conditions relating to the moon's orbit and essential to the accuracy of the saros are fulfilled. Solar and lunar eclipses are alike predictable by it.

A total eclipse of the sun occurred in the southern United States, 28th May, 1900; and reckoning forward from that date by means of the saros, we might predict the eclipses of 8th June, 1918, and 19th June, 1936. But only in a general way; if the precise circumstances of the eclipse are required, and the places where it will be visible, a computation must be made from the Ephemeris, or Nautical Almanac. Mark the effect of the one third day in the saros: the eclipse at each recurrence falls visible about 120° of longitude farther west; in 1900 visible in the United States, in 1918 on the Pacific Ocean, in 1936 in central Asia. A period of 54 years 1 month 1 day, or three times the length of the saros, will therefore bring a return of an eclipse in very nearly the same longitude, but its track will always be displaced several hundred miles in latitude. For example, the total eclipse of 8th July, 1842, was observed in central Europe; but its return, 9th August, 1896, fell visible in Norway. About 70 eclipses usually take place during a saros, of which about 40 are eclipses of the sun, and 30 of the moon.

Life History of an Eclipse.—As to eclipses in their relation to the saros, every eclipse may be said to have a life history. Whatever its present character, whether partial, total, or annular, it has not always been so in the past, nor will its character continue unchanged in the indefinite future. New and very small partial eclipses of the sun are born at the rate of about four every century; they grow to maturity as total and annular eclipses, and then decline down their life scale as merely partial obscurations, becoming smaller and smaller until even the moon's penumbra fails to touch the earth, and the eclipse completely disappears. For a lunar eclipse, this long cycle embraces nearly 900 years, that is, the number of returns according to the saros is almost 50; but solar eclipses, for which the ecliptic limit is larger, will return nearly 70 times, and last through a cycle of almost 1200 years.

Occultations of Stars and Planets by the Moon.—Closely allied to eclipses are the phenomena called occultations. When the moon comes in between the earth and a star or planet, our satellite is said to occult it. There are but two

phases, the disappearance and the reappearance; and in the case of stars, these phases take place with startling suddenness. Disappearances between new and full, and reappearances between full and new, are best to observe, because they take place at the dark edge or limb of the moon. When the crescent is slender, a very small telescope is sufficient to show these interesting phenomena for the brighter stars and planets. Occultations of the Pleiades are most interesting and important. Many hundreds of occultations of stars are predicted in the Nautical Almanac each year. Occultations of the major planets are very rare.

Chapter XIII

The Planets

Tethered by an overmastering attraction to the central and massive orb of the solar system are a multitude of bodies classified as planets. Next beyond the moon, they are nearest to us of all the heavenly spheres, and telescopes have on that account afforded astronomers much knowledge concerning them. But before presenting this we first consider their motions, and the aspects and phases which they from time to time exhibit.

Motions—Classification—Aspects—Phases

Apparent Motions of the Planets.—Watch the sky from night to night. Nearly all the bright stars, likewise the faint ones, appear to be fixed on the revolving celestial sphere; that is, they do not change their positions with reference to each other. But at nearly all times, one or two bright objects are visible which evidently do not belong to the great system of the stars considered as a whole; these shift their positions slowly from week to week, with reference to the fixed stars adjacent to them. The most ancient astronomers detected these apparent motions, and gave to such bodies the general name of planets; that is, wanderers. Their movements among the stars appear to be very irregular—sometimes advancing toward the east, then slowing down and finally remaining nearly stationary for different lengths of time, and again retrograding, that is, moving toward the west. But their advance motion always exceeds their motion westward, so that all, in greater or less intervals, journey completely round the heavens. None of the brighter ones are ever found outside of the zodiac; in fact, Mercury, which travels nearest to the edge of this belt, is always about two moon breadths within it. A study of the apparent motions of all the planets reveals a great variety of curves. If the motions of the planets could be watched from the sun, there would be no such complication of figures; for they exist only because we observe from the earth, itself one of the planets, and continually in motion as the other sun-bound bodies are.

Planets' Motions explained by the Epicycle.—The irregular motions of the planets among the stars were ingeniously explained by the

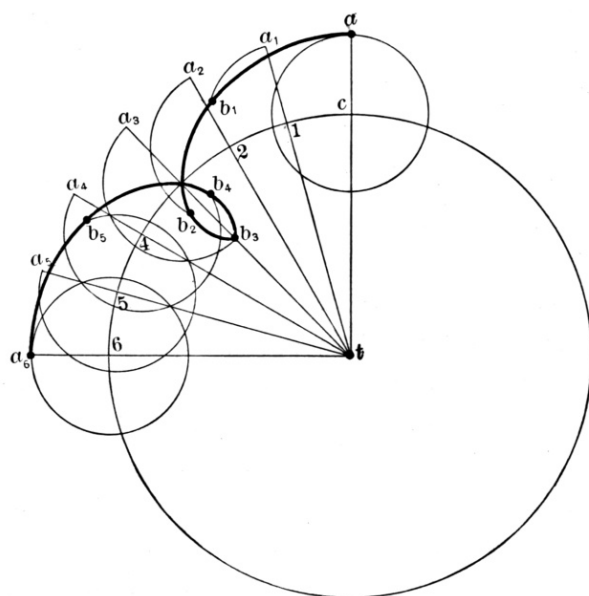

A Planet's Motion in the Epicycle

ancient astronomers from the time of Hipparchus (B.C. 130) onward, by means of the epicycle. A point which moves uniformly round the circumference of a small circle whose center travels uniformly round the periphery of a large one, is said to describe an epicycle.

The figure should make this plain: the center, c , of the small circle, called the epicycle, moves round the center t of the large circle, called the *deferent*; and at the end of each 24th part of a revolution, it occupies successively the points 1, 2, 3, 4, 5, and

so on. But while c is moving to 1, the point a is traversing an arc of the deferent equal to a_1b_1 . By combination of the two motions, therefore, the point a will traverse the heavy curve, reaching the points indicated by b_1, b_2, b_3, b_4, b_5 , when c arrives at corresponding points 1, 2, 3, 4, 5. In passing from b_2 to b_4 the planet will turn backward, or seem to describe its retrograde arc among the stars. By combining different rates of motion with circles of different sizes, it was found that all the apparent movements of the planets could be almost perfectly explained. This false system, advanced by Ptolemy (A.D. 140) in his great work called the *Almagest*, was in vogue until overthrown by Copernicus on the publication of his great work *De Revolutionibus Corporum Coelestium* in 1543.

Naked-eye Appearance of the Planets.—Mercury can often be seen in all latitudes of the United States by looking just above the eastern horizon before sunrise (in August, September, or October), or just above the western horizon after sunset (in February, March, or April). In these months the ecliptic stands at a very large angle with the horizon, and Mercury will appear as a rather bright star in the twilight sky, always twinkling violently. Venus, excepting sun and moon the brightest object in the sky, is known

to everybody. She is always so much brighter than any of the other planets that she cannot be mistaken—either easterly in the early mornings or westerly after sunset, according to her orbital position relatively to the earth. Usually, when passing near the sun, Venus cannot be seen because the sun overpowers her rays. During periods of greatest brilliancy, however, Venus is not difficult to see with the naked eye when near the meridian in a clear blue sky. Mars, when visible, is always distinguishable among the stars by a brownish red color. Distance from both earth and sun varies so greatly that he is sometimes very faint, and again when nearest, exceedingly bright. Jupiter comes next to Venus in order of planetary brightness. Though much less bright than Venus, he is still brighter than any fixed star. Saturn is difficult to distinguish from a star, because he shines with about the order of brightness of a first magnitude star. His light has a yellowish tinge, and by looking closely, absence of twinkling will be noticed. Unless very near the horizon, none of the planets except Mercury ever twinkle; and this simple fact helps to distinguish them from fixed stars near them. Uranus, just on the limit of visibility without the telescope may be seen during spring and summer months, if one has a keen eye and knows just where to look. Also Vesta, one of the small planets, may at favorable times be seen without a telescope. Neptune is never visible without optical aid.

Convenient Classifications of the Planets.—Neither apparent motion, nor naked-eye appearance, however, affords any basis for classification of the planets. But distance from the sun and size do. In order of distance, succession of the eight principal planets with their symbols is as follows, proceeding from the sun outward:—

☿ Mercury, ♀ Venus, ♂ Earth, ♂ Mars, ♃ Jupiter, ♄ Saturn, ♅ Uranus, ♆ Neptune. Of these, Mercury and Venus, whose orbits are within the earth's, are classified as inferior planets, and the other five from Mars to Neptune, as superior planets. In the same category would be included the ring of asteroids, or small planets, between Mars and Jupiter. The real motions of the planets round the sun are counter-clockwise, or from west toward east.

Also the planets are often conveniently classified in three distinct groups:—

(I) The inner or terrestrial planets, Mercury, Venus, Earth, Mars; also the unverified intramercurian bodies.

(II) The asteroids, or small planets, sometimes called planetoids, or minor planets.

(III) The outer or major planets, Jupiter, Saturn, Uranus, Neptune.

In this classification the zone of asteroids forms a definite line of demarcation; but the basis is chiefly one of size, for all the terrestrial planets are very much smaller than the outer or major planets. Here may be included also the zodiacal light, and the *gegenschein*, both faint, luminous areas of the nightly sky. Probably their light is mere sunlight reflected from thin clouds of meteoric matter entitled to consideration as planetary bodies, because, like the planets, each particle must pursue its independent orbit round the sun. All the planetary bodies of whatever size, together with their satellites, the sun itself, and multitudes of comets and meteors, are often called the solar system.

Configurations of Inferior Planets.—In consequence of their motions round the central orb, Mercury and Venus regularly come into line

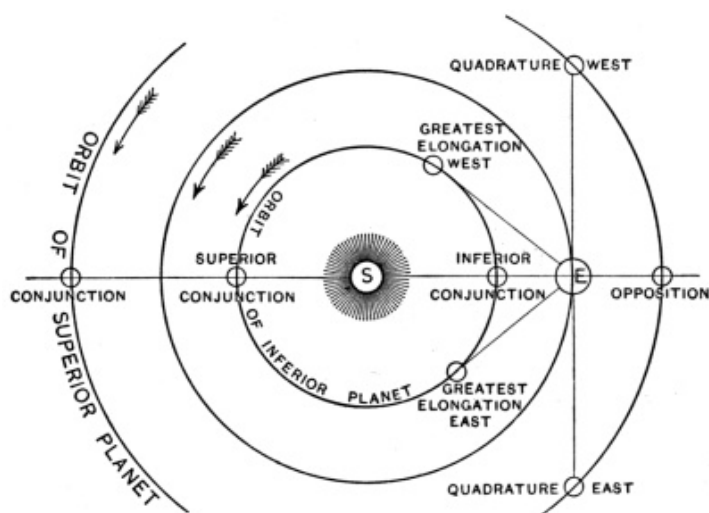

Aspects of Inferior and Superior Planets

with earth and sun, as illustrated in above diagram. If the planet is between us and the sun, this configuration is called *inferior conjunction*; *superior conjunction*, if the planet is beyond that luminary. At inferior conjunction, distance from earth is the least possible; at superior conjunction, the greatest possible. On either side of inferior conjunction the inferior planets attain greatest brilliancy; with Mercury this occurs about three weeks, and with Venus about five weeks, preceding and following inferior conjunction. For many days near this time, Venus is visible in the clear blue even at midday; but in a dark sky her radiance is almost dazzling, and with every new recurrence she deceives the uneducated afresh.

Near her western elongation, in 1887–88, many thought she was the ‘Star of Bethlehem’; and in 1897 multitudes in New England gave credence to a newspa-

per story that the brilliant luminary was an electric light attached to a balloon sent up from Syracuse, and hauled down slowly every night about 9 P.M. The following are times of greatest brilliancy of Venus:—

Elongation east, and visible after sunset: May, 1908; Jan., 1910; Aug., 1911; Mar., '13; Oct., '14; May, '16; Dec., '17; Aug., '19.

Elongation west, and visible before sunrise: Jan., 1907; Aug., 1908; Mar., 1910; Oct., '11; June, '13; Jan., '15; Aug., '16; Mar., '18; Oct., '19.

Greatest Elongation of Inferior Planets.—An inferior planet is at greatest elongation when its angular distance from the sun, as seen from the earth, is as great as possible.

The following illustrations help to make these points clear. The earth is at the eye of the observer, and a thin disk about 18 inches in diameter, and held about one foot from the eye, represents the plane of the orbits of the inferior planets. They travel round with the arrows, passing superior conjunction when farthest away from the eye, and therefore of their smallest apparent size. Coming round to greatest elongation, they are nearer and larger, and their phase is that of the quarter moon. The angle between Venus and the sun is then 47° . Mercury at a like phase may be as much as 28° distant; but his orbit is so eccentric that if he is near perihelion at the same time, he may be only 18° from the sun.

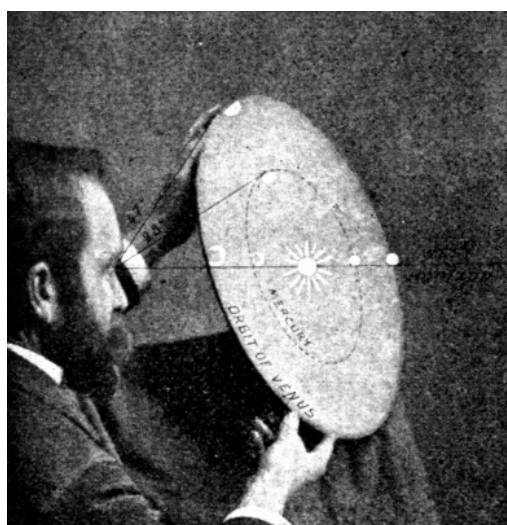

Inferior Planets at Greatest Elongation East (after Sunset in Spring)

Passing on to inferior conjunction, the phase is a continually diminishing crescent, of a gradually increasing diameter, as shown. The figure on the current page represents the apparent position of the orbits (relative to horizon) when the greatest eastern elongations occur in our springtime. The observer is looking west at sunset, and the planets at elongation shine far above the horizon in bright twilight, and are best and most conveniently seen. When greatest elongations west of the sun occur, one must look eastward for them, before sunrise, as in the adjacent illustration (autumn inclination to east horizon). The ancients early knew that Venus in these two relations was one and the same planet; but they preserved the poetic distinction of a double name,—Phosphorus for the morning star, and Hesperus for the evening.

Configurations of Superior Planets.—By virtue of the position of superior planets outside our orbit, they may recede as far as 180° from

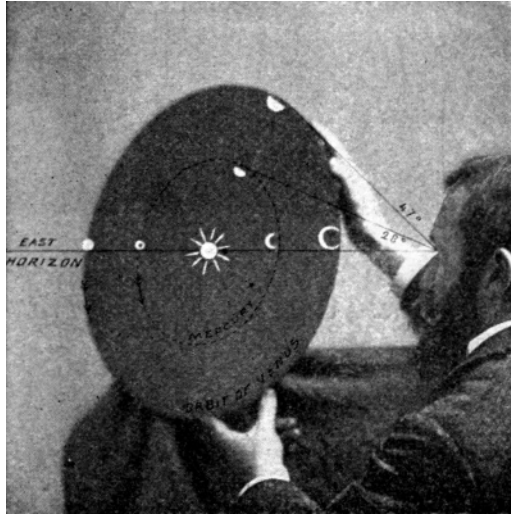

Inferior Planets at Greatest Elongation
West (before Sunrise in Autumn)

the sun. Being then on the opposite side of the celestial sphere, they are said to be in opposition (page 280). When in the same part of the zodiac with the sun, they are in conjunction. Halfway between these two configurations a superior planet is in quadrature; that is, an elongation of 90° from the sun. Opposition, conjunction, and quadrature usually refer to the ecliptic, and the angles of separation are arcs of celestial longitude, nearly. Sometimes, however, it is necessary to use *conjunction in right ascension*.

Inferior planets never come in opposition or even quadrature, because their greatest elongations are much less than 90° .

The Phases of the Planets.—Some of the planets, as observed with the telescope, are seen to pass through all the phases of the moon. Others are seen at times to resemble certain lunar phases; while still others have no phase whatever. To the first class belong the inferior planets, Mercury and



Phases and Apparent Size of the Planet Mercury

Venus. On approaching inferior conjunction, their crescent becomes more and more slender, like that of the very old moon when coming to new; while from inferior conjunction to superior conjunction, they pass through all the lunar phases from new to full. As in the case of the moon, the horns of the crescent are always turned from the sun (toward it, as seen in the inverting telescope). When near their greatest elongation, the phase of these planets is that of the moon at quarter. One of Galileo's first discoveries with the

first astronomical telescope, in 1610, was the phase of Venus. None of the superior planets can pass through all the phases of the moon, because they never can come between us and the sun.

The degree of phase which they do experience, however, is less in proportion as their distance beyond us is greater. Mars, then, has the greatest phase. At quadrature the planet is gibbous, about like the moon three days from full. Mars appears at maximum phase in Figure 13.40. But at opposition, his disk, like that of all other planets, appears full. Some of the small planets, too, give evidence of an appreciable phase: not that it can be seen directly, for their disks are too small, but by variation in the amount of their light from quadrature to opposition, as Parkhurst has determined. Jupiter at quadrature has a slight, though almost inappreciable, phase. Other exterior planets—Saturn, Uranus, and Neptune—have practically none.

Loop of a Superior Planet's Apparent Path Explained.—Refer to the figure. The largest ellipse, *ABCD*, is the ecliptic. Intermediate ellipse is orbit of an exterior planet; and smallest ellipse is the path of earth itself. A planet

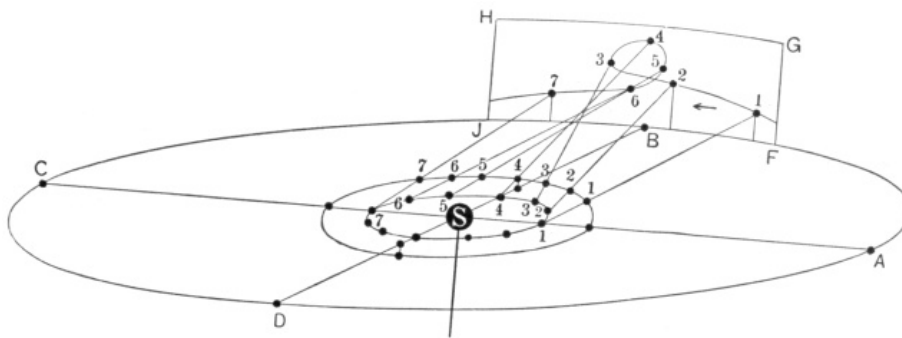

To explain Formation of Loop in Exterior Planet's Path

when advancing always moves in direction *GH*. The sun is at *S*. When earth is successively at points marked 1, 2, 3, 4, 5, 6, 7 on its orbit, the outer planet is at the points marked 1, 2, 3, 4, 5, 6, 7 on the middle ellipse. So that the planet is seen projected upon the sky in the directions of the several straight lines. These intersect the zone *F, G, H, J*, of the celestial sphere in the points also marked upon it 1, 2, 3, 4, 5, 6, 7, and among the stars of the zodiac. Following them in order of number, it is evident that the planet advances from 1 to 3, retrogrades from 3 to 5, and advances again from 5 to 7. Also its backward motion is most rapid from 3 to 4, when the planet is near opposition, and its distance from earth is the least possible. In general, the nearer the planet to earth, the more extensive its loop.

A Planet when Nearest Retrogrades.—First consider the inferior planets of which Venus may be taken as the type. Fixed stars are everywhere round the outer ring, representing the zodiac (on this page). Within are two large arrows flying in the counter-clockwise direction in which the planets really move round the sun. Earth's orbit is the outer circle in the left-hand figure, and the dotted circle within is the orbit of Venus. As Venus moves more swiftly than the earth does, evidently the latter may be regarded as stationary, and Venus as moving past it at the upper part of the orbit, where inferior conjunction takes place. But Venus in this position appears to be among the stars far beyond the sun, consequently her real motion forward seems to be motion backward among the stars, as indicated by the right-hand arrow at the bottom. Next, consider the exterior planet,

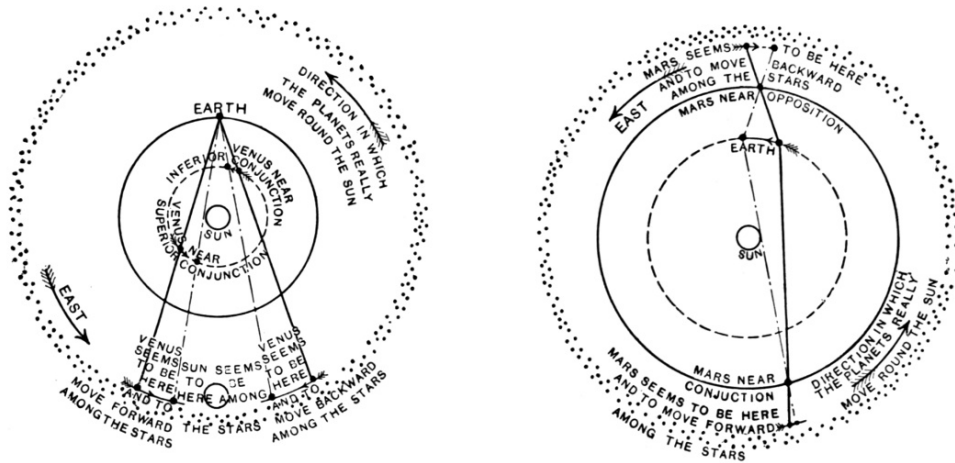

Inferior Planets retrograde at Inferior Conjunction

Superior Planets retrograde at Opposition

All Planets retrograde when nearest to, and advance when farthest from, the Earth

of which Mars may be taken as the type. In the right-hand figure, inner circle is orbit of earth, and outer, orbit of Mars; and as earth moves more swiftly than Mars, earth may be regarded as the moving body and Mars as stationary. In the upper part of the figure occurs opposition, and earth overtakes Mars and moves on past him. But Mars is seen among the stars above and beyond it, and evidently his apparent motion is westerly, or retrograde, in the direction of the small arrow at the top of the figure. Thus is reached the conclusion that the *apparent motion of all the planets, whether inferior or superior, is always retrograde when they are nearest the earth.*

A Planet when Farthest Advances.—Return to the inferior planet Venus, and the left-hand figure; when farthest she is in the lower part of her orbit, and her apparent position is among the stars still farther below, west or to the left of the sun. Advance or eastward motion in orbit, then, appears as advance motion forward among the stars. Seemingly, Venus is moving toward the sun, and will soon overtake and pass behind him. Now the exterior planet again. Assuming Mars to remain stationary in the position of the black dot in lower part of orbit, earth (in upper part of orbit, where distance between the two is nearly as great as possible) moves eastward in the direction of the arrow through it. As a consequence of this motion, then, Mars seems to travel forward on the opposite or lower side of the celestial sphere (in the direction of a very minute arrow near the bottom of the figure). Thus is reached this general conclusion: *The apparent motion of all the planets, whether inferior or superior, is always retrograde when they are nearest the earth, and advance or eastward when farthest from it.*

Orbits—Elements—Periods—Laws of Motion

The Four Inner or Terrestrial Planets.—On page 286 are charted the orbits of the four inner planets, Mercury, Venus, earth, and Mars. Observe that while Venus and the earth move in paths nearly circular, with the sun very near their center, orbits of Mercury and Mars are both eccentrically placed. So nearly circular are the orbits of all planets that, in diagrams of this character, they are indicated accurately enough by perfect circles. Orbits having a considerable degree of eccentricity are best represented by placing the sun a little at one side of their center.

The double circle outside the planetary orbits represents the ecliptic, graduated from 0° eastward, or counter-clockwise, around to 360° of longitude, according to the signs of the zodiac, as indicated; the vernal equinox, or the first point of the sign Aries corresponding to 0° . Small black dots on each orbit represent positions of the planets at intervals of ten days, zero for each planet being at longitude 180° . All the planets travel round the sun eastward, or counter-clockwise, as indicated by arrows. In order to find the distance of any planet from earth, or from any other at any time, first find the position of the two planets in their respective orbits by counting forward or backward from the dates given for each planet on the corners outside the chart, when they are at longitude 180° . Then with a pair of dividers the distance may be found from the scale of millions of miles underneath.

The Four Outer and Major Planets.—On page 287 is a chart of the orbits of the four outer planets, Jupiter, Saturn, Uranus, and Neptune. Observe that these orbits are all sensibly circular and concentric, except that of Uranus, the center of which is slightly displaced from the sun. The double outer circle

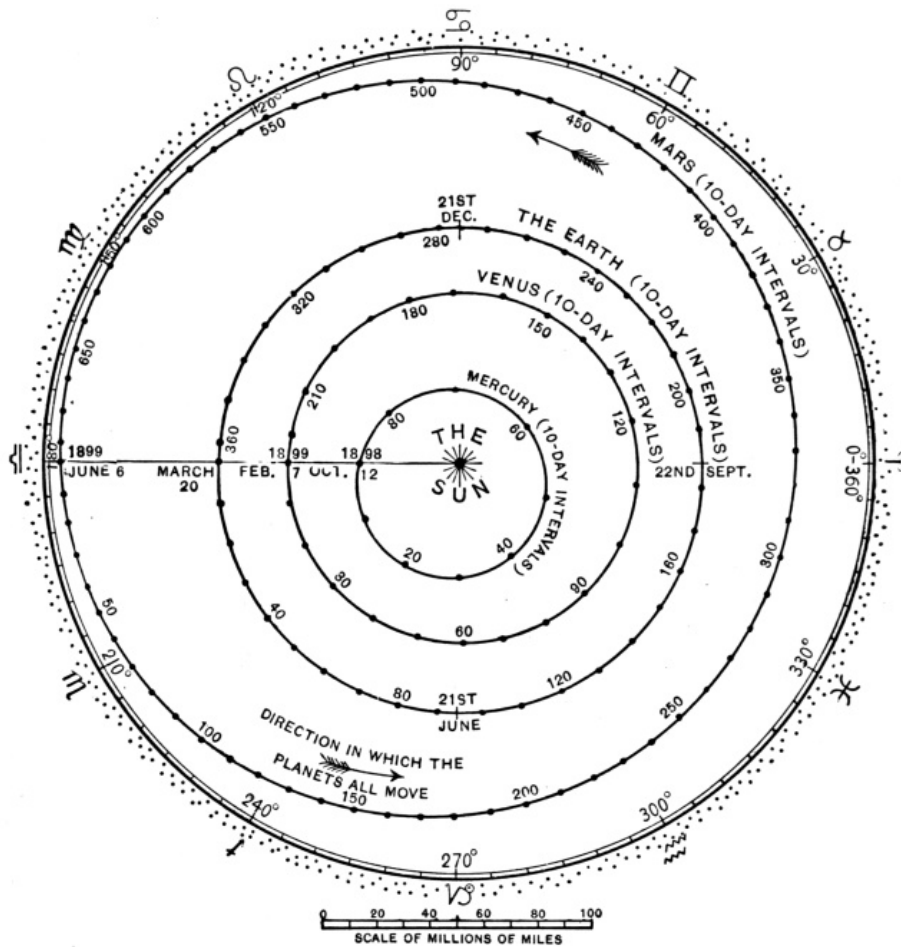
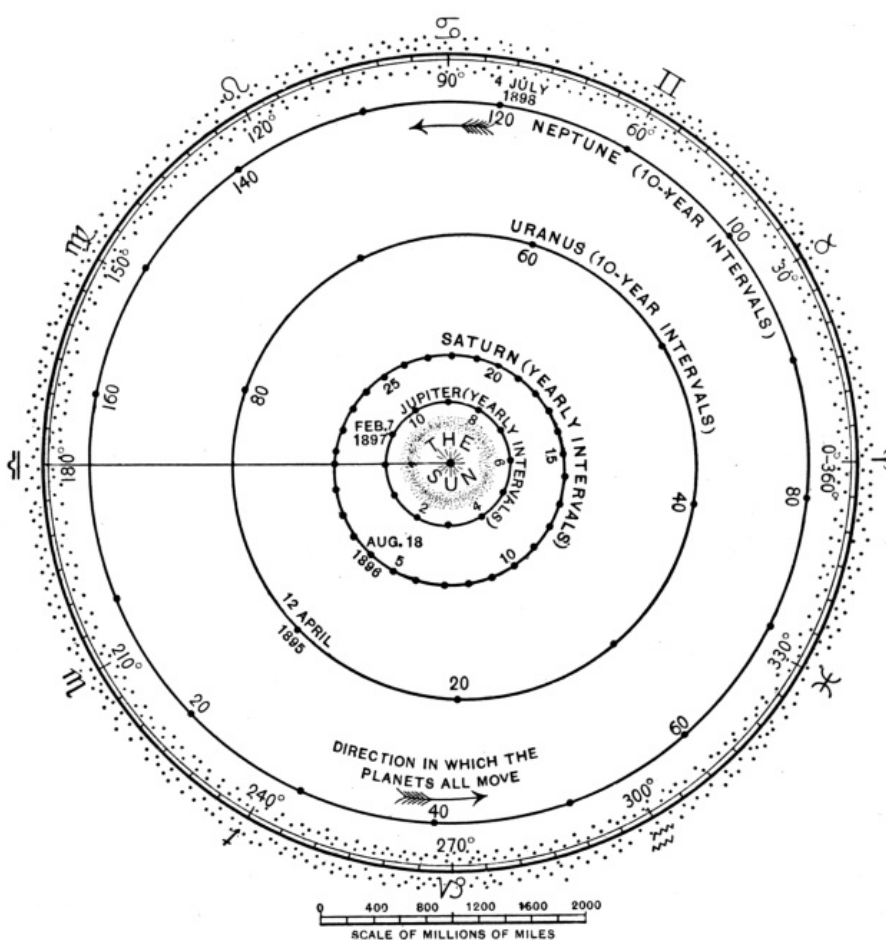

Illustration: Orbits and Heliocentric Movements of the Four Terrestrial Planets

represents the ecliptic, the same as in the diagram on the current page. The small black dots on the orbits of Jupiter and Saturn represent the positions of these planets at intervals a year in length; and similarly, the positions of Uranus and Neptune are indicated at 10-year intervals; the zero in every case being coincident with longitude 180° . The distance of these planets from each other, or from the earth at any time, may be found in the same way as described on this page for the inner planets.

True Form of the Planetary Orbits.—Were it possible to transport our observatory and telescope from earth to each of the planets in turn, and then repeat the measures of the sun's diameter with great refinement, just as we did from the earth (page 119), we should reach a result precisely similar in every case. So the conclusion is, that the orbits of all the planets



Orbits and Heliocentric Movements of the Four Greater Planets

are ellipses, so situated in space that the sun occupies one of the foci of

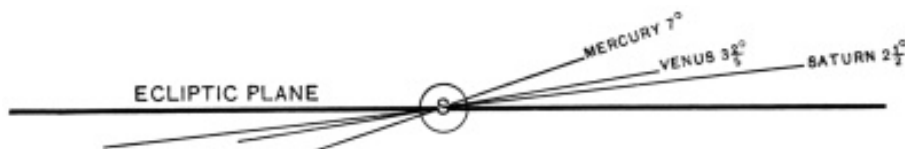

Planetary Orbits having Greater Inclinations to the Ecliptic

each ellipse. None of them would lie in the same plane that the earth does, but each planet would have an ecliptic of its own, in the plane of which its orbit would be situated.

Table 13.1: ECCENTRICITY AND VARIATION OF DISTANCE FROM THE SUN

ECCENTRICITY		CHANGE OF DISTANCE DUE TO ECCENTRICITY	
Mercury,	0.2056	15	} Millions of miles
Venus,	0.0068	1	
Earth,	0.0168	3	
Mars,	0.0933	26	
Jupiter	0.0482	47	
Saturn,	0.0561	90	
Uranus,	0.0464	166	
Neptune,	0.0090	49	

Inclination and Line of Nodes.—The orbits of all the great planets, except Mercury, Venus, and Saturn, are inclined to the ecliptic less than 2° . Saturn's inclination is $2\frac{1}{2}^\circ$, that of Venus $3\frac{2}{5}^\circ$, and Mercury's 7° , as in the diagram. Orbits of the small planets stand at much greater angles; six are inclined more than 25° , and the average of the group is about 8° . The two opposite points where a planet's orbit cuts the ecliptic are called its *nodes*.

Eccentricity of their Orbits.—The eccentricity of Mercury is $\frac{1}{5}$, of Mars $\frac{1}{11}$, of Jupiter, Saturn, and Uranus about $\frac{1}{20}$, and of Venus and Neptune very slight. The chief effect of the eccentricity is to change a planet's distance from the sun, between perihelion and aphelion; and to vary the speed of revolution in orbit. On page 288 are eccentricities of the planetary orbits, together with total variation of distance due to eccentricity.

Some of the small planets have an eccentricity more than double that of Mercury even, so that their perihelion point is near the orbit of Mars, while at aphelion they wander well out toward the path of Jupiter. The average eccentricity of their orbits is excessive, being about equal to that of Mercury. The path of Andromache (175) is very like the orbit of Tempel's comet II (page 350).

Synodic Periods.—Just as with the moon, so each planet has two kinds of periods. A planet's sidereal period is the time elapsed while it is journeying once completely round the sun, setting out from conjunction with some fixed star and returning again to it. If during this interval the earth remained stationary as related to the sun, the times occupied by the planets in traversing the round of the ecliptic would be their true sidereal

periods. But our continual eastward motion, and the apparent motion of sun in same direction, makes it necessary to take account of a second period of revolution—the synodic period, or interval between successive conjunctions. If a superior planet, the average interval between oppositions is also the synodic period. Following are the

Table 13.2: SYNODIC PERIODS

THE TERRESTRIAL PLANETS	THE MAJOR PLANETS
Mercury 116 days	Jupiter 399 days
Venus 584 days	Saturn 378 days
Mars 780 days	Uranus 370 days
	Neptune 368 days

The exceptional length of the synodic periods of Venus and Mars is due to the fact that their average daily motion is more nearly that of the earth than is the case with any of the other planets.

Sidereal Periods.—As our earth is a moving observatory, it is impossible for us to determine the sidereal periods of the planets directly from observation. But their synodic periods may be so found; and from them the true or sidereal periods are ascertained by calculation, involving only the relation of the earth’s (or sun’s apparent) motion to that of the planet. They are as follows:—

Table 13.3: SIDEREAL PERIODS OR PERIODIC TIMES

THE TERRESTRIAL PLANETS	THE MAJOR PLANETS
Mercury 88 days	Jupiter $11\frac{7}{8}$ years
Venus 225 days	Saturn $29\frac{1}{2}$ years
The Earth $365\frac{1}{4}$ days	Uranus 84 years
Mars 687 days	Neptune 165 years

Periodic times of the small planets range between $1\frac{3}{4}$ and $8\frac{3}{4}$ years.

Kepler’s Laws.—Kepler, to whom the motions of the planets were a mystery, nevertheless had discovered in 1619 three laws governing their motions. (I) the orbit of every planet is elliptical in form, and the sun is situated at one of the foci of the ellipse. (II) The motion of the radius vector, or line joining the planet to the sun, is such that it sweeps over equal

Table 13.4: VERIFICATION OF KEPLER'S THIRD LAW

NAME OF PLANET	PERIODIC TIME (IN DAYS)	MEAN DISTANCE (EARTH'S DISTANCE = 1)	$\frac{[\text{TIME}]^2}{[\text{DISTANCE}]^3}$
Mercury	87.97	0.3871	133,414
Venus	224.70	0.7233	133,430
Earth	365.26	1.0000	133,415
Mars	686.95	1.5237	133,400
Ceres	1681.41	2.7673	133,408
Jupiter	4332.58	5.2028	133,272
Saturn	10759.22	9.5388	133,400
Uranus	30688.82	19.1833	133,410
Neptune	60181.11	30.0551	133,403

areas of the ellipse in equal times. (III) The squares of the periodic times of the planets are proportional to the cubes of their average distances from the sun. Kepler was unable to give any physical explanation of these laws. He merely ascertained that all the planets appear to move in accordance with them.

Verification of Kepler's Third Law.—A half hour's calculation suffices to prove the truth of this law. The results are shown in the last column of the following table, where the number in each line was obtained by dividing the square of the planet's periodic time by the cube of its mean distance from the sun.

The third law of Kepler, often called the 'harmonic law,' is rigorously exact, only upon the theory that planets are mere particles, or exceedingly small masses relatively to the sun. On this account the discrepancy in the last column is quite large, in the case of Jupiter, because his mass is nearly $\frac{1}{1000}$ that of the sun.

Mean Distances of the Planets.—Kepler's third law enables us to calculate a planet's average distance from the sun, once its time of revolution is known; for regarding the earth's period of revolution as unity (one year), and our distance from the sun as unity, it is only necessary to square the planet's time of revolution, extract the cube root of the result, and we have the planet's mean distance from the sun. For example, the periodic time of Uranus is 84 years; its square is 7056; the cube root of which is 19.18. That is, the mean distance of Uranus from the sun is 19.18 times our own distance from that central luminary. Its distance in miles, then, will be $19.18 \times 93,000,000$. In like manner may be found the distances of all the other planets from the sun; and they are as follows:—

Table 13.5: MEAN DISTANCE FROM SUN

THE TERRESTRIAL PLANETS		THE MAJOR PLANETS	
Mercury	36	Jupiter . . .	$483\frac{1}{3}$
Venus	$67\frac{1}{5}$	Saturn . . .	886
The Earth	93	Uranus . . .	1780
Mars	$141\frac{1}{2}$	Neptune	2790

These distances are all represented in true relative proportion in the figure on page 295. Scattered over a zone about 280 millions of miles broad, or $\frac{5}{6}$ of the distance separating Mars from Jupiter, is the ring of small planets, or asteroids probably many thousand in number, of which about 600 have already been discovered.

The Nearest and the Farthest Planet.—Mars is often said to be the nearest of all the planets, because his orbit is so eccentric that favorable oppositions, as shown later in the chapter, may bring him within 35,000,000 miles of the earth. But Venus comes even nearer than that. Her distance from the sun subtracted from ours gives 26,000,000 miles for the average distance of Venus from the earth at inferior conjunctions; and Venus may approach almost 2,000,000 miles nearer than this, if conjunction comes in December or January, near earth’s perihelion. But we find that the nearest planet of all is an asteroid discovered in the year 1898. About one half its orbit lies nearer the sun than the nearer half of Mars’s orbit does; and once in 30 years it comes to perihelion and opposition at about the same time. Its distance from us is then less than 14,000,000 miles. This planet (No. 433) is named Eros. Of the known planets the farthest from the earth is Neptune. So far away is he that we must multiply the least distance of Venus more than a hundredfold in order to obtain the distance of Neptune from the earth.

Aberration Time.—Knowing the velocity of light by experiment, and knowing the distances of the planets from us, it is easy to calculate the time consumed by light in traveling from any planet to the earth. So distant is Neptune, for example, that light takes about $4\frac{1}{4}$ hours to reach us from that planet. This quantity is called the planet’s aberration time, or the equation of light. Its value in seconds for any planet is equal to 499 times the planet’s distance from the earth (expressed in astronomical units).

Newton’s Law of Gravitation.—Sir Isaac Newton about 1675 simplified the three laws of motion of the planets into a single law, hence known as the Newtonian law of gravitation. It has two parts of which the first is

this: that every particle of matter in the universe attracts every other particle directly as its mass or quantity of matter; and second, that the amount of this attraction increases in proportion as the square of the distance between the bodies decreases. That Kepler's three laws are embraced in this one simple law of Newton may be shown by a mathematical demonstration. With a few trifling exceptions, all the bodies of the solar system move in exact accordance with Newton's law, whether planets themselves, their satellites, or the comets and meteors. Newton's law is often called 'The Law of Universal Gravitation,' because it appears to hold good in stellar space as well as in the solar system itself.

Elements of Planetary Orbits.—The mathematical quantities which determine the motion of a celestial body are called the elements of its orbit. They are six in number, and they define the size of the orbit, its shape, and its relation to the circles and points of the celestial sphere.

- (1) a Mean distance, or half the major axis of the ellipse in which the planet moves round the sun.
- (2) e Eccentricity, or ratio of distance between center and focus of ellipse to the mean distance.
- (3) Ω Longitude of ascending node, or arc of great circle between this node and the vernal equinox.
- (4) i Inclination of plane of orbit to ecliptic.
- (5) π Longitude of perihelion, or angle between line of apsides and the vernal equinox.
- (6) ϵ Longitude of the planet at some definite instant, often technically called the *epoch*.

Once the exact elements of an orbit are found, the undisturbed motion of the body in that orbit can be predicted, and its position calculated for any past or future time.

Secular Variations of the Elements.—About a century ago, two eminent mathematical astronomers of France, La Grange and La Place, made the important discovery that the action of gravitation among the planets can never change the size of their orbits; that is, the element a , or the mean distance, always remains the same. As for the other elements affecting the shape of the orbit and its position in space, they can only oscillate harmlessly between certain narrow limits in very long periods of time. These slow and minute fluctuations of the elements are called *secular variations*; and they may be roughly represented by holding a flexible and nearly circular hoop between the hands, now and then compressing it slightly, also wobbling it a little, and at the same time slowly moving the arms one about the other. The oscillatory character of the secular variations secures the permanence and stability of our solar system, so long as it is not subjected

to perturbing or destructive influences from without. One who really wishes fully to understand these complicated relations must undertake an extended course of mathematical study—the only master key to complete knowledge of the planetary motions.

Colors—Albedo—Bode's Law—Relative Distances

A Planet when Nearest looks Largest.—In proportion as a planet comes nearer to us, its apparent disk fills a larger angle in the telescope. The

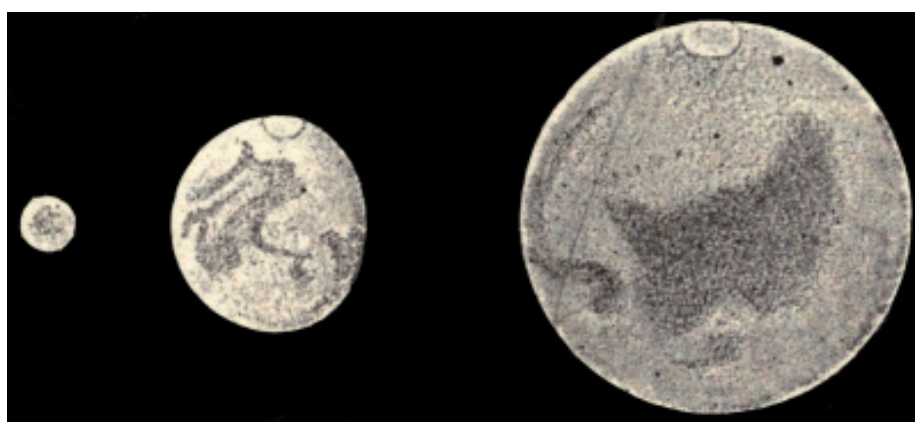

Variation in Apparent Size of Mars

two planets, then, nearest the earth, Venus within our orbit, and Mars without, must undergo the greatest changes in apparent diameter, because their greatest distance is many times their least. Mars, at nearest to the earth, is 35,000,000 miles away; at farthest, more than seven times as distant. This seeming variation in size is shown in above figure. The next greatest variation is exhibited by Venus (lower figure); at superior conjunction her diameter seems to be only one sixth as great as at inferior conjunction.



Variation in Apparent Size of Venus

The figure illustrates not only this marked increase of her diameter as she comes toward us, but her phases also. Third in order is Mercury, whose diameters at greatest and least distance are about as 1 to 3 (already shown on page 282).

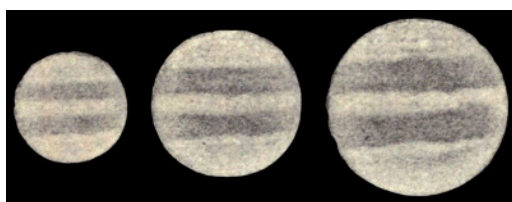

Variation in Apparent Size of Jupiter

And following Mercury is Jupiter, whose variations are accurately shown in the adjacent figure. Saturn, Uranus, and Neptune, too, show fluctuations of the same character, but much less, because of their very great distance from us. From conjunction to opposition, the apparent breadth of Saturn increases only about one third; while

the similar increase of Uranus and Neptune is so slight that a micrometer is necessary to measure it.

Apparent Magnitudes and Colors of the Planets.—All the planets vary in brightness, as their distance from the sun and the earth varies. Five of them shine with an average brightness exceeding that of a first magnitude star. Of these, Venus is by far the brightest, and Jupiter next, the others following in the order Mars, Mercury, and Saturn. Uranus is about equivalent to a star of the sixth magnitude. Also a few of the small planets approach this limit when near opposition. But Neptune's vast distance from both sun and earth renders him as faint as an eighth magnitude star, so that he is invisible without at least a small telescope. The colors of the planets are:

Mercury, pale ash;
 Venus, brilliant straw;
 Mars, reddish ochre;
 Jupiter, bright silver;
 Saturn, dull yellow;
 Uranus, pale green;
 Neptune, the same.

The entire significance of these colors is not yet known; but apparently they are indicant as to degree and composition of atmosphere enveloping each.

Albedo of the Planets.—Albedo is a term used to express the capacity of a surface, like that of a planet, to reflect light. It is a number expressing the ratio of the amount of light reflected from a surface to the amount which falls upon it. By observations of a planet's light with a photometer, it can be compared with a star or another planet, and its albedo found by computation. The moon's surface reflects about $\frac{1}{6}$ the light falling upon it from the sun. The albedo of Mercury is even less, or $\frac{1}{8}$; but the surface of Venus is highly reflective, its albedo being $\frac{1}{2}$. The albedo of Mars is about $\frac{1}{4}$; that of Saturn and Neptune, about the same as Venus; while the albedo of Jupiter and Uranus is the highest of all the planets, or nearly $\frac{2}{3}$. This means that their surfaces reflect about four times as much light as sandstone does.

The So-called Law of Bode.—Titius discovered a law which approximately represents the relative distances of the planets from the sun. It is derived in this way. Write this simple series of numbers, in which each except the second is double the one before it:

0	3	6	12	24	48	96
Add 4 to each, giving						
4	7	10	16	28	52	100

The actual distances of the planets known in the time of Titius (1766) are as follows (the earth's distance being represented by 10):

3.9	7.2	10	15.2	—	52.0	95.4
☿	♀	♁	♂	{ small } planets	♃	♆

Although the law is by no means exact, Bode, a distinguished German astronomer, promulgated it. On that account it is always called Bode's law. Except historically, this so-called law is now of no importance; for its error, when extended to the outer planets, Uranus and Neptune, is even greater than in the case of Saturn. But by directing attention to a break in succession of planets between Mars and Jupiter, Bode's law led to telescopic search for a supposed missing body; a search speedily rewarded by discovery of the first four small planets, ① Ceres, ② Pallas, ③ Juno, and ④ Vesta.

Relative Distances and Orbital Motions.—Once the distances of the planets have been found, measures of their disks with the telescope enable us to calculate their true dimensions. One need not try to improve upon Sir John Herschel's illustration of the relative distances, sizes, and motions in the solar system. 'Choose any well-leveled field or bowling green. On it place a globe two feet in diameter; this will represent the sun; Mercury will be represented by a grain of mustard seed, on the circumference of a circle 164 feet in diameter for its orbit; Venus a pea, on a circle of 284 feet in diameter; the earth also a pea, on a circle of 430 feet; Mars a rather large pin's head, on a circle of 654 feet; the asteroids, grains of sand, in orbits of from 1000 to 1200 feet; Jupiter a moderate-sized orange, in a circle nearly half a mile across; Saturn a small orange, on a circle of four fifths of a mile; Uranus a full-sized cherry or small plum, upon the circumference of a circle more than a mile and a half; and Neptune a good-

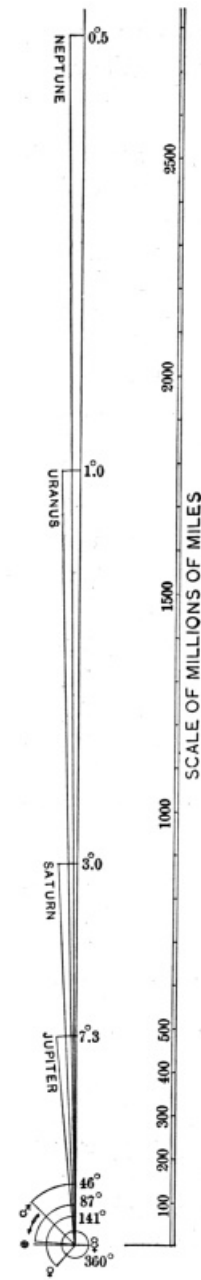

Relative Distances and Orbital Motions of the Planets

sized plum, on a circle about two miles and a half in diameter. . . . To imitate the motions of the planets, in the above-mentioned orbits, Mercury must describe its own diameter in 41 seconds; Venus, in 4 *m.* 14 *s.*; the earth, in 7 *m.*; Mars, in 4 *m.* 48 *s.*; Jupiter, in 2 *h.* 56 *m.*; Saturn, in 3 *h.* 13 *m.*; Uranus, in 2 *h.* 16 *m.*; and Neptune, in 3 *h.* 30 *m.*.' A farther and helpful idea of relative motion of the planets may be obtained from the figure, in which Mercury's period round the sun is taken as the unit. While he is moving 360°, that is in 88 days, the other planets move over the arcs set down opposite their distance from the sun. This makes very apparent how much the motion of planets decreases on proceeding outward from the sun. If Neptune moves as an athlete runs, Mercury speeds round with the celerity of a modern locomotive.

Sizes—Masses—Axial Rotation—Tidal Evolution

The Size of the Planets.—Regarding the group of small planets as a dividing line in the solar system, all planets inside that group are, as previously said, relatively small, and all outside it large. The illustration on the current page serves to show this well, presenting not only the relative sizes of the planets, but also the relation of their diameters to the sun's. More particularly the mean diameters are:—

Inner Terrestrial Planets	{	Mercury,	3,000 miles
		Venus,	7,700 miles
		Earth,	7,920 miles
		Mars,	4,200 miles

Group of small planets: Ceres the largest, 490 miles in diameter.

Outer Major Planets	{	Jupiter,	87,000 miles
		Saturn,	73,000 miles
		Uranus,	32,000 miles
		Neptune,	32,000 miles

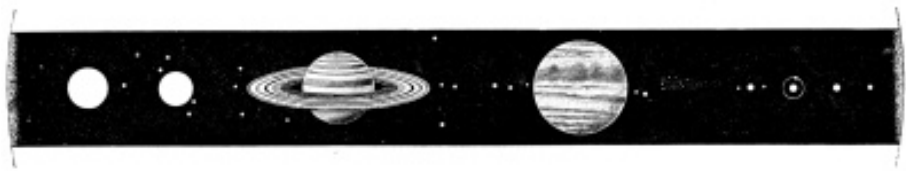

Relative Sizes of Planets (Sun's Diameter on Same Scale equals Length of the Cut)

Other small planets whose diameters have been measured (by Barnard) are Pallas, 300 miles; Juno, 120 miles; Vesta, 240 miles. Probably none of

the others are as large as Juno, and the average of recent faint discoveries cannot exceed 20 miles.

Masses and Densities of Planets.—Best by comparison can some idea of the masses of the planets be conveyed. Relative weights of common things are helpful, and sufficiently precise: Let an ordinary bronze cent piece represent the earth. So small are Mercury and Mars that we have no coin light enough to compare with them; but these two planets, if merged into a single one, might be well represented by an old-fashioned silver three-cent piece; Venus, by a silver dime; Uranus, a silver dollar, half dollar, and quarter together; Neptune, two silver dollars; Saturn, eleven silver dollars; and Jupiter, thirty-seven silver dollars (rather more than two pounds avoirdupois). An inconveniently large sum of silver would be required if this comparison were to be carried farther, so as to include the sun; for he is nearly 750 times more massive than all the planets and their satellites together, and, on the same scale of comparison, he would somewhat exceed the weight of the long ton. In striking contrast with this vast and weighty globe are the tiny asteroids, so light that 300 of them have been estimated to have a mass of only $\frac{1}{3000}$ that of our earth. If we derive the densities of planets as usually, by dividing mass by volume, we find that Mercury is the densest of all (one fifth denser than the earth). Venus, Earth, and Mars come next, the last a quarter less dense than our globe. Three of the major planets have about the same density as the sun himself; that is, only one fourth part that of the earth. Saturn's mean density is the least of all, only one eighth that of our globe.

Center of Gravity of the Sun and Jupiter.—Though the sun's mass is vastly greater than that of his entire retinue of planets put together, he is nevertheless forced appreciably

out of the position he would otherwise occupy by the powerful attraction of the giant planet whose mass is $\frac{1}{1047}$ his own. It is easy to calculate how much, for the sun and Jupiter revolve round their common center of gravity, exactly as if the two vast globes, *S* and *J* were connected by a rigid rod of steel.



Jupiter balancing the Sun

But as *S* weighs 1047 times as much as *J*, the center of gravity of the system is $\frac{1}{1048}$ of the distance between the centers of *S* and *J*. Now as Jupiter in perihelion makes this distance 460,000,000 miles, the center of gravity is displaced from *S* toward *J* 440,000 miles. But the radius of the sun is 433,000 miles; so the center of gravity of the Sun-Jupiter system is never less than 7000 miles outside the solar orb. And this distance becomes greater as Jupiter recedes to his aphelion.

Axial Rotation of the Planets.—The giant planet turns most swiftly on his axis, for the average period of rotation of the white belt girdling his equator is only 9 h. 50 $\frac{1}{3}$ m. But, like the sun, his zones in different latitudes revolve in different periods, the average of which is about 9 h. 55 $\frac{1}{2}$ m. The period of revolution of the great red spot averages 9 h. 55 m. 39 s. Saturn, too, exhibits similar discrepancies, but the white spots of his equatorial belts gave, in 1893, a period of 10 h. 12 m. 53 s. There are indications that the axial period of Uranus is about the same; but that of Neptune is unknown. Then comes our earth with its day of 23 h. 56 m. 4.09 s. Next in order of length is Mars, whose day is equal to 24 h. 37 m. 22.7 s., a constant known with great precision, because it has been determined by observing fixed markings upon the surface, and the whole number of revolutions is many thousand. Following, though at a long distance, are Mercury and Venus, which turn round but once on their axes while going once round the sun. The axial period (sidereal) of the former, then is 88 days; and of the latter, 225 days,—the longest known in the solar system. Her solar day, therefore, is infinite in duration, and her year and sidereal day are equal in length. This equality of periods, in both Mercury and Venus, was undoubtedly effected early in their life history, through the agency of friction of strong sun-raised tides in their masses, then plastic.

Ellipticity and Axial Inclination of the Planets.—The disks of many of the planets do not appear perfectly circular, but exhibit a degree of flattening at the poles. This is due to rotation about their axes, the centrifugal force producing an equatorial bulge. In the case of Jupiter and Saturn, it is so marked as to attract immediate attention on examining their disks with the telescope. The polar flattening of Saturn's ball is $\frac{1}{9}$ (page 323), of Uranus $\frac{1}{12}$, and of Jupiter $\frac{1}{16}$ (page 320), these planets being exceptionally large, and their axial rotation relatively swift. Next comes Mars, whose polar flattening is $\frac{1}{190}$, followed by the earth's, $\frac{1}{300}$. The ellipticity of the other planets, of the satellites, and of the sun itself, is so small as to escape detection. Inclination of planetary equator to plane of orbit round the sun is excessive in the case of Uranus; also probably in Neptune; has a medium value (about 25°) for the earth, Mars, and Saturn; and is very slight for all the other three great planets.

Librations of the Planets.—There are librations of planets, just as there are librations of the moon. But the only planetary libration we need to consider is libration in longitude. This is due to the fact that while the planet turns with perfect uniformity on its axis, its revolution in orbit is swifter near perihelion, and slower near aphelion than the average. The amount of a planet's libration in longitude, therefore, will depend upon the degree of eccentricity of its orbit; and it must be taken into account in

finding the true period of the planet's day.

Mercury's libration is the greatest of all. His average daily angle of rotation is about 4° ; but at perihelion he moves round the sun more than 6° , and at aphelion rather less than 3° daily. The effect of libration is an apparent oscillation of the disk, alternately to the east and west. Starting from perihelion, the angle of revolution in orbit gains about 2° each day on the angle of axial turning; the amount of gain constantly diminishing, until nearly three weeks past perihelion. Mercury's libration is then at its maximum, amounting to $23\frac{1}{2}^\circ$ at the center of the disk. In the opposite part of his orbit, the disk seems to swing as much in the opposite direction, making thus the extent of the angle of Mercury's libration equal to 47° . On $\frac{3}{8}$ of his surface, then, the sun never shines. On $\frac{3}{8}$ it is perpetually shining, and on $\frac{1}{4}$ there is alternate sunshine and shadow. So, too, on Mars, there is an apparent libration of the center of the disk, though not so large as Mercury's, because his orbit is less elliptical; and the sun shines on every part of the surface, because the rotation and revolution periods of Mars are not equal. Still less are the librations of Jupiter and Saturn, their eccentricity of orbit being only about half that of Mars.

Tidal Evolution.—By tidal evolution is meant the distinct rôle played by tides in the progressive development of worlds. The term *tide* is here used, not in its common or restricted sense, applying to waters of the ocean, but to that periodic elevation of plastic material of a world in its early stages, occasioned by gravitation of an exterior mass. Newton's law of gravitation first gave a full explanation of the rising and falling of ocean tides, but as applied to motions of planets, it presupposed that all these bodies were rigid. In 1877, George Darwin, in a series of elaborate mathematical papers, showed the effect of gravitation upon these masses in earlier stages of their history, when, according to the nebular hypothesis, they were not rigid, but composed of yielding material. Ocean tides are raised at the gradual, though almost inappreciable, expense of earth's energy of rotation. In like manner, earth-raised tides in the youthful moon continued to check its axial rotation until that effect was completely exhausted, and the moon has never since turned on its axis relatively to the earth. Evidently this effect of tidal friction has been operant in the case of sun-raised tides upon the planets,—more powerfully if the planet is nearer the sun; less powerfully if its mass is great; also less powerfully if its materials have early become solidified on account of the planet's small size. Combination of these conditions explains the present periods of rotation of all the planets: Mercury and Venus strongly acted upon by the sun, so that they now and for all time turn their constant face toward him; earth, also probably Mars, even yet suffering a very slight lengthening of their day; Jupiter and Saturn, also

probably Uranus and Neptune, still endowed with swift axial rotation, because of (1) their massiveness, and (2) their vast distance from the center of attraction.

Transits—Satellites—Atmospheres—Surfaces

Transits of Inferior Planets.—If either Mercury or Venus at inferior conjunction is near the node of the orbit, the planet can be seen to pass across the sun like a round black spot. This is called a transit. About 13 transits of Mercury take place every century, the shortest interval being $3\frac{1}{2}$ years, and the longest 13. They can happen only in the early part of May and November, because the earth is then near the nodes of Mercury's orbit. There are about twice as many transits in November as in May, because Mercury's least distance from the sun falls near the November node. Transits of Venus occur in pairs, eight years apart; and the intervals between the midway points of the pairs are alternately $113\frac{1}{2}$ and $129\frac{1}{2}$ years. June and December are the only possible months for their occurrence, and a June pair in one century will be followed by a December pair in the next. Both Mercury and Venus at transit, being then nearest the earth, their apparent motion is westerly or retrograde. Consequently a transit always begins on the east side of the sun. Duration of transit varies with the part of the disk upon which the planet seems to be projected, whether north or south of the center or directly over the middle.

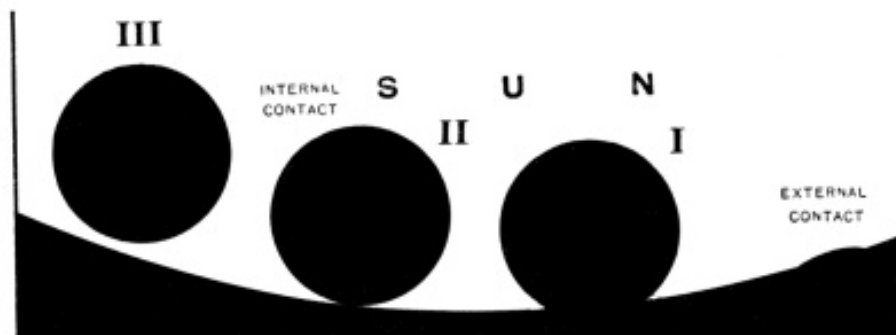

Contacts at Ingress

Contacts at Ingress and Egress.—Hold the book up south. The white arc in the figure adjacent will then represent the east limb of the sun, upon which the planet enters at ingress, or beginning of transit, as seen in an ordinary astronomical telescope. Upper part of figure shows the phase called *external contact*. Actual geometric contact cannot of course be observed, because it is

impossible to see the planet until its edge has made a slight notch into the sun's limb. The observer catches sight of this as soon as possible, and records the time as his observation of external contact. The planet then moves along to the left, until it reaches the phase shown at I, a few seconds before internal contact. The observer must then watch intently the bright horns, which will soon close in rapidly toward each other, and finally a narrow filament of light will shoot quickly across and join the two horns together. This will be internal contact shown at II. After a few seconds the planet will have advanced to III, well within the limb of the sun. Then there will be little to observe until the planet has crossed the solar disk, and is about to present the phases of egress. These will be exactly similar to those at ingress, but will take place in reverse order. The atmosphere of Venus (page 307) complicates observations of these contacts, and they cannot be observed within two or three seconds of time.

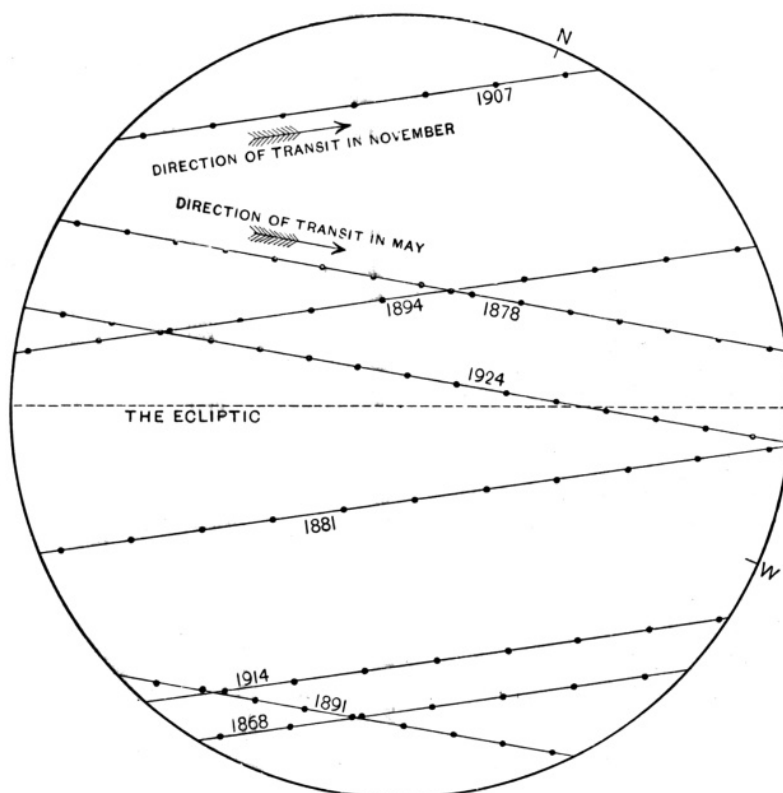

Paths of Transits of Mercury at Ascending and Descending Nodes

Past and Future Transits of Mercury.—Gassendi made the first observation of a transit of Mercury in 1631. The annexed engraving shows the paths of Mercury during all transits from 1868 to 1924. The circle represents the disk of the sun; near the top is north, and below the right side west. The broken line

is part of the ecliptic. Consider first the November transits. Their dates are: 5th November, 1868; 7th November, 1881; 10th November, 1894; 14th November, 1907; 6th November, 1914. Mercury is then near ascending node; and the paths of these transits are drawn at an ascending angle of about 7° to the ecliptic, this being the inclination of Mercury's orbit to that plane. Dots on these paths show positions at half-hour intervals. Observe how far apart they are. This is because Mercury is near perihelion, where swifter motion carries him quickly across the sun. Next, consider the May transits. They are only three in number in the same interval, and their dates are: 6th May, 1878; 9th May, 1891; 7th May, 1924. They occur near Mercury's descending node, as shown, that of 1924 being nearly central because Mercury happens to come to inferior conjunction with the earth, at very nearly the time of reaching its node. The half-hour dots are nearer together than in November transits, because Mercury is near aphelion, and consequently his motion is as slow as possible. The greatest length of a transit of Mercury is 7 h. 50 m., and the transit of 1924 approaches near this limit.

Past and Future Transits of Venus.—Jeremiah Horrox made the first observation of a transit of Venus in 1639. Nearly every century witnesses a pair of these transits. Below are four disks representing the sun; and upon them are

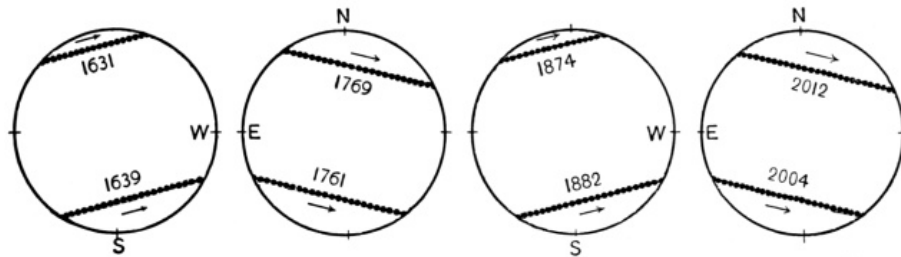

Paths of Transits of Venus at Ascending and Descending Nodes

indicated apparent paths of Venus, for all transits occurring in the 17th to the 21st centuries inclusive. In each case the top of the disk is north, and the right-hand side west. The dots show the position of the planet at intervals of fifteen minutes. Pairs of transits take place at average intervals of $\frac{1}{5}$ centuries; so there will be no transit of Venus in the 20th century.

As is evident from the figure, a pair of transits at ascending node (1631 and 1639) is followed by a pair at descending node (1761 and 1769), and so on alternately. Southern transits at ascending node (1639 and 1882) are followed by southern transits at descending node (1761 and 2004); and a northern transit at descending node (1769) is followed by a northern transit at ascending node. Rows of black dots in contact with each other indicate the chord of the sun's disk traversed at each transit, as seen from the center of the earth. The greatest possible length of a transit of Venus is 7 h. 58 m., and the shortest one ever

Table 13.6: DATES OF TRANSITS OF VENUS

AT THE ASCENDING NODE	AT THE DESCENDING NODE
1631, December 7	1761, June 5
1639, December 4	1769, June 3
1874, December 9	2004, June 8
1882, December 6	2012, June 6

observed was that of 1874. Transits of Venus are phenomena of great interest to astronomers, because proximity of the planet produces a large effect of parallax. By measuring it, her distance from the earth is found. This tells us the scale on which the solar system is built, including therefore the length of the unit in astronomical measures, the sun's mean distance from the earth. The transits of 1769 and 1882 were visible in the United States. Those of 1874 and 1882 were extensively observed by costly expeditions under the auspices of the principal governments.

Satellites of the Planets

Satellites of the Terrestrial Planets.—The solar system has this curious and interesting feature, that most of its chief planets are accompanied by moons or satellites. Twenty-six are now known. No satellite has yet been discovered belonging to either of the inferior planets. There have, however, been many spurious observations of a supposed satellite of Venus. Our earth has but one. Mars has two satellites, discovered by Hall in 1877. They are about seven miles in diameter, and can, be seen only by large telescopes under favorable conditions. Phobos, the inner moon of Mars, is less than 4000 miles from the planet's surface, and travels round in 7 h. 39 m., a period less than one third that of Mars' rotation. To an observer on the planet, Phobos must, therefore, seem to rise in the west and set in the east. Its horizontal parallax is enormous, being $21\frac{1}{5}^\circ$. The outer moon, Deimos, is rather more than 12,000 miles from the surface of Mars, and its periodic time is 30 h. 18 m. As the planet's day is 24 h. 37 m., Deimos must consume, allowing for parallax, about $2\frac{1}{2}$ days in leisurely circuiting the Aerean sky from horizon to horizon.

Satellites of the Major Planets.—Jupiter has eight moons. The four large ones (see table below) were discovered by Galileo in 1610, with the first telescope ever used astronomically. They move in nearly circular orbits. The fifth or innermost moon was discovered in 1892 by Barnard.

Table 13.7: THE INNER SATELLITES OF JUPITER

NUMBER	DIAMETER (miles)	DISTANCE FROM JUPITER (miles)	SIDEREAL PERIOD OF REVOLUTION				MASS IN TERMS OF JUPITER
V	100	112,000	0 d. 11 h. 57 m. 22.7 s.				?
I	2500	261,000	1	18	27	33.5	$\frac{1}{60000}$
II	2100	415,000	3	13	13	42.1	$\frac{1}{44000}$
III	3600	664,000	7	3	42	33.4	$\frac{1}{11000}$
IV	3000	1,167,000	16	16	32	11.2	$\frac{1}{25000}$

In 1904–1905, Perrine of the Lick Observatory discovered by means of photography a sixth outer satellite of Jupiter revolving round him in a period of 251 days; also a seventh moon, period 260 days. An eighth moon, also exceedingly faint, was found photographically by Melotte at Greenwich in 1908, with a period of 830 days. Saturn is very rich in attendants, having not only the wonderful rings (quite different from everything else in the solar system, and undoubtedly made up of an infinity of small individual bodies or satellites, too small ever to be separately seen), but in addition ten distinct satellites are known. Uranus has four moons, and far-away Neptune has one attendant body.

Periods, Transits, Occupations, and Eclipses.—Table 13.7 shows the principal data of the inner satellites of Jupiter.



Jupiter (Shadow of
Satellite in Transit)

So near Jupiter is the fifth satellite that his disk, as seen from the surface of the satellite, would stretch more than half way from horizon to zenith. Referring to conditions which produce eclipses of sun and moon, illustrated on page 260, and remembering that the orbits of the large satellites nearly coincide with the plane of his path, it is clear that eclipses of the sun and of Jupiter's moons must occur every time a satellite goes round the planet. So there are nearly 9000 eclipses of the sun and moons annually, from some point or other of Jupiter's disk. The IV satellite alone escapes eclipse—about half the time. When the dark shadow of a satellite is seen to cross the disk, it is called a transit of the shadow; and the projection of the satellite itself on the disk is called a transit of the satellite.

In the opposite part of their orbits, a satellite's passing behind the disk is called an occultation; and its dropping into the planet's shadow is called an eclipse. Eclipses vary from just a few minutes to nearly five hours in length. Eclipses, occultations, and transits are predicted many years in advance in the *Ephemeris*, and are very interesting to observe, even with small telescopes. An opera glass will show at a glance the moons which are not in transit, occultation, or eclipse. Sometimes all four disappear for a time.

Light requires Time to travel.—In 1675, Roemer first suspected this, because he found that when Jupiter was in opposition, eclipses of his satellites took place several minutes earlier than the average, and when in conjunction, the same amount later. The figure shows why; for when Jupiter is in conjunction, sunlight reflected from a satellite must journey an entire diameter of the earth's orbit farther than at opposition. Eclipses of all four moons exhibited the same discrepancy. So the conclusion was manifest, that light requires a definite time to travel; and we now know, from elaborate calculations, that light from these moons travels across the earth's orbit in 998 seconds. Half this number, or 499, is the constant factor in 'the equation of light.' Its careful determination is a matter of great importance, and eclipses of Jupiter's satellites are now recorded with high accuracy by the photometer and by means of photography.

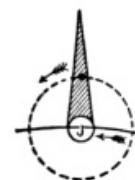

Physical Peculiarities of Jupiter's Satellites.—The first satellite is not a sphere, but a prolate ellipsoid, its longer axis being directed toward the center of Jupiter—a remarkable peculiarity discovered by W. H. Pickering and verified by Douglass. Markings, very faint in character, have been seen upon all the satellites. By means of these their periods of axial revolution are found. Fading out at the edge may be indication that III possesses an atmosphere. Satellites III and IV, also probably II, turn around once on their axes while going once around Jupiter, a relation like that of our moon to the earth. Douglass, from observations of very narrow belts on III in 1897, makes its period of rotation 7 d. 5 h. Also he has published the above sketch-map of the satellite's surface. Near the poles of

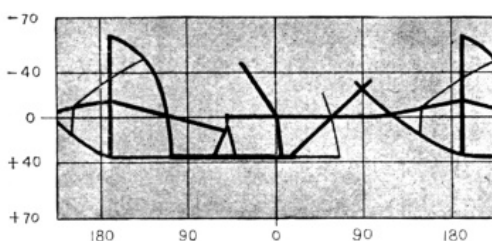

Markings on Jupiter's 3d Satellite
(Douglass)

Table 13.8: THE SATELLITES OF SATURN

NUMBER	NAME OF SATELLITE NAME OF DISCOVERER	DATE OF DISCOVERY	DIAMETER	DISTANCE FROM SATURN	SIDEREAL PERIOD OF REVOLUTION			
					d.	h.	m.	s.
I	Mimas W. Herschel	17 Sept. 1789	750	117,000	0	22	37	5.7
II	Enceladus W. Herschel	28 Aug. 1789	800	157,000	1	8	53	6.9
III	Tethys J. D. Cassini	21 Mar. 1684	1100	186,000	1	21	18	25.6
IV	Dione J. D. Cassini	21 Mar. 1684	1200	238,000	2	17	41	9.3
V	Rhea J. D. Cassini	23 Dec. 1672	1500	332,000	4	12	25	11.6
VI	Titan C. Huygens	25 Mar. 1655	3000	771,000	15	22	41	23.2
X	Themis W. H. Pickering	28 Apr. 1905	40	906,000	20	20	24	...
VII	Hyperion W. C. Bond	16 Sept. 1848	500	934,000	21	6	39	27.0
VIII	Iapetus J. D. Cassini	25 Oct. 1671	2000	2,225,000	79	7	54	17.1
IX	Phoebe W. H. Pickering	14 Mar. 1899	40	8,110,000	550.44 days			

III and IV white spots have been seen by several observers. Douglass makes the rotation period of I to be 12 h. 24 m.

Satellites of Saturn.—Table 13.8 shows the principal data of the satellites of Saturn.

The orbits of the five inner satellites are circular. The satellites first discovered are easiest to see, the largest, Titan, being nearly always visible even with very small instruments. Its mass according to Stone is $\frac{1}{4600}$ that of Saturn. Eclipses and transits of some of the satellites have occasionally been observed with large telescopes.

Satellites of Uranus.—Table 13.9 shows the principal data of the satellites of Uranus:—

The two inner satellites are about 500 miles in diameter, and the outer ones are nearly twice as large. For about thirty years, while the earth

Table 13.9: THE SATELLITES OF URANUS

NUMBER	NAME OF SATELLITE	DISTANCE FROM URANUS (miles)	SIDEREAL PERIOD OF REVOLUTION			
I	Ariel	120,000	2 d.	12 h.	29 m.	21.1 s.
II	Umbriel	167,000	4	3	27	37.2
III	Titania	273,000	8	16	56	29.5
IV	Oberon	365,000	13	11	7	6.4

is near a line perpendicular to their orbits, the satellites may always be seen whenever Uranus is visible. Only great telescopes, however, will show them. The satellites of Uranus revolve in planes nearly at right angles to the planet's orbit, and their motion is retrograde, or from east to west. Ariel and Umbriel were discovered by Lassell in 1851; Titania and Oberon, by Sir William Herschel in 1787.

Satellite of Neptune.—Its distance from Neptune is 224,000 miles, the period of revolution 5 d. 21 h. 3 m., with motion retrograde. It was discovered by Lassell in 1846, only a few weeks after the planet itself was found. Probably Neptune's satellite is about the size of our own moon.

Atmospheres of the Planets

Atmosphere of Mercury.—Without much doubt, the atmosphere of Mercury is inappreciable. His color by day, when best observable, resembles that of the pale moon under like conditions. If there is no air, then quite certainly no water; as evaporation would continue to supply a slight atmosphere as long as it lasted. The improbability of an atmosphere surrounding this planet is confirmed by the argument from the kinetic theory of gases, already stated (page 216); for Mercury's mass is too slight to retain an envelope of aqueous vapor.

Atmosphere of Venus.—Observations of Venus when very near her inferior conjunction prove the existence of an atmosphere which is thought to be more dense than ours. The illustration shows part of the evidence: Venus is just entering upon the sun's disk during the transit of 1882, and sunlight shining through the planet's atmosphere illuminates it in a nearly complete ring surrounding Venus, which appears dark because her sunward side is turned away from us. Also an aureole surrounds the dark disk when in transit; and on several occasions when Venus has passed close above or below the sun at inferior conjunction, just escaping a transit, the



Venus entering the Disk of the Sun in 1882 (Langley)

horns of the atmospheric ring have been observed almost to meet, forming a nearly complete ring. This crescent would be little more than a complete semicircle, if there were no atmosphere.

Atmosphere of Mars.—Doubtless a thin atmosphere envelops this planet, although neither so extensive nor so dense as our own. While usually cloudless, occasional and temporary veilings of some of the best known regions of the planet have been seen. Many careful investigators, using the spectroscope, have found absorption lines in the spectrum of Mars thought to be due to neither solar nor terrestrial atmosphere, indicating water vapor in a gaseous envelope. Also regular shrinking and subsequent enlarging of the polar caps are excellent evidence that the ruddy planet is sur-

rounded by a medium acting as an agent in the formation and deposition of snow. Changing intensity of the light, with a change of the planet's phase also indicates the presence of an atmosphere. Another important piece of evidence is the discovery of a twilight arc of about 12° , causing a regular increase of the planet's apparent diameter through the equator, as phase increases. Quite certainly density of the atmosphere of Mars cannot exceed one half that of our own, and probably it is very much less. Referring again to the kinetic theory of gases, and calculating the critical velocity for Mars, we find it to be rather more than three miles per second. Free hydrogen, then, could not be present in his atmosphere, but other gases might. Campbell and Keeler have found the spectrum of Mars practically identical with that of the moon, indicating probably that the spectroscopic method is inconclusive.

Atmosphere of Jupiter and Saturn.—The indications of a dense and very extended atmosphere encircling Jupiter are unmistakable:—ceaseless changes in markings called belts and spots; varying length of the planet's day in different regions of latitude; absorption shadings in the inferior portion of Jupiter's spectrum; and withal his giant mass potent to retain captive all gaseous materials originally belonging to him. Probably in point of both depth and chemical constitution, the atmosphere of Jupiter is widely diverse from our own; in fact, it is not unlikely that this great planet may still be in a gaseous condition throughout. At least the depth of atmosphere must be reckoned in thousands of miles. Dark bands in the red may

be due to some substance in the planet's atmosphere not in our own, and possibly metallic. In nearly every respect the atmosphere of the ball of Saturn resembles that of Jupiter, but the ring gives every appearance of being without atmosphere. Saturn's spectrum, too, is quite the same as Jupiter's, and its intenser absorption bands indicate a little more plainly the presence of gaseous elements as yet unrecognized on the earth and in the sun. Another indication of atmosphere, common to both these planets, is the shading out or absorption of all markings at the limb or edge of their disks.

Atmosphere of Uranus and Neptune.—So remote are these planets, and so small their apparent disks, that practically nothing has yet been ascertained concerning their atmospheres except by the spectroscope. Uranus is bright enough so that its spectrum shows 10 broad diffused bands, between *C* and *F*, indicating strong absorption by a dense atmosphere very different from that of the earth, as Keeler has shown. The position of these lines in the red is sufficient to account for the sea-green tint of the planet. Neptune's color is almost the same; and its spectrum, if not so faint, would probably show similar absorption bands.

Surfaces of the Planets

Zodiacal Light.—Interior to the orbit of Mercury, but possibly stretching out beyond the path of the earth, is a widely diffused disk of interplanetary particles moving round the sun, mildly reflecting its rays to us, and called the zodiacal light. Douglass first photographed it in 1901.

Figure 13.26 shows it well—a faintly luminous and ill-defined triangular area, expanding downward along the ecliptic toward the western horizon, shortly after twilight on clear, moonless nights from January to April. Its central region is brightest and slightly yellowish. It has suffered no change for more than two centuries. Its spectrum is short and continuous, without bright lines, though possibly a few faint dark ones are present. In tropic latitudes, where the ecliptic always stands high above the horizon, the zodiacal light can be well seen in clear skies the year round. In our middle latitudes it cannot be seen early in autumn evenings, because of the slight inclination of

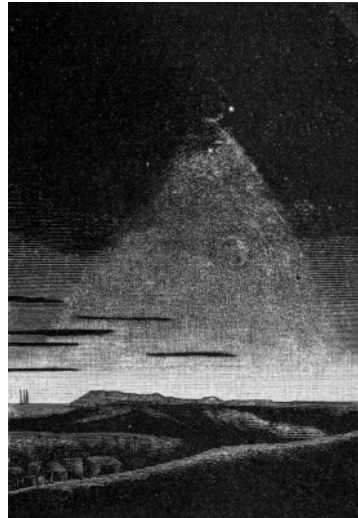

The Zodiacal Light in Tropic Latitudes

of the slight inclination of

the ecliptic to the horizon, as the next figure shows: that part of the zodiacal

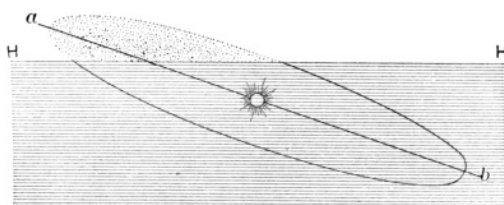

Why Zodiacal Light is Invisible in our Fall Evenings

light near *a* and above the horizon, *HH*, is lost in low-lying mist and haze. In autumn it must be looked for in the east just before dawn, leaning toward the right in our latitudes.

The Gegenschein.—This is a name of German origin, given to a zodiacal counter-glow discovered by Brorsen in 1854—an exceedingly faint and evenly diffused nebulous light, nearly opposite the sun, sometimes

slightly south and again somewhat north of the ecliptic. A bright star or planet near by is sufficient to overmaster its light; even proximity to the Milky Way obliterates it. Sometimes the gegenschein is circular, at others elliptic; and its diameter varies between 3° and 13° , according to Barnard and Douglass. It is best seen in September and October, in Sagittarius and Pisces. No satisfactory theory as to its cause exists. Very likely the gegenschein is due to clouds of small interplanetary bodies, though possibly it may be caused by abnormal refraction in our atmosphere.

Surface of Mercury.—Mercury is so small a planet and so distant from the earth that the disk is disappointing. In the northern hemisphere he is best seen near greatest elongation east in spring, and greatest elongation west in autumn; because he is then in the northernmost part of the zodiac, where meridian altitude is as great as possible. Markings on the surface of Mercury are described by Lowell as less difficult than those on Venus; without color, and lines rather than patches; and the fact that they do not change from hour to hour, nor perceptibly from day to day, shows that the planet's periods of rotation and revolution are the same. Above are nine drawings of the planet in October, 1896; also on the facing page Lowell's chart of all that portion of the surface of Mercury ever visible, amounting to five eighths of the entire spherical superficies. The surface is probably rough, because, like the moon, the amount of light reflected from a unit of surface increases from crescent phase to full.

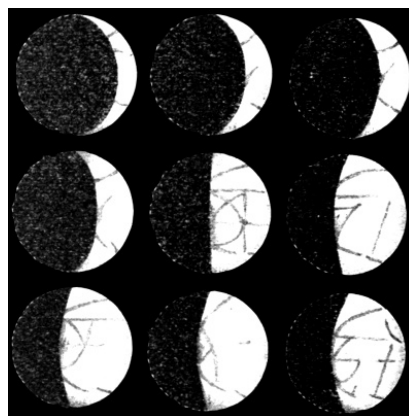

Typical Drawings of Mercury, 1896 (Lowell)

Illuminated Hemisphere of Venus.—The unilluminated half of Venus appears to be forever sealed from investigation by our eyes; but that part of

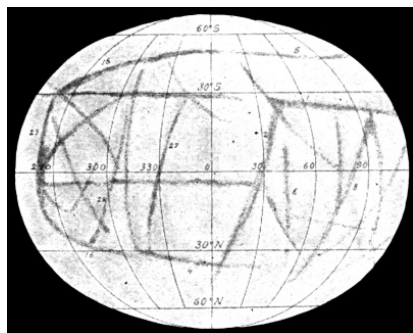
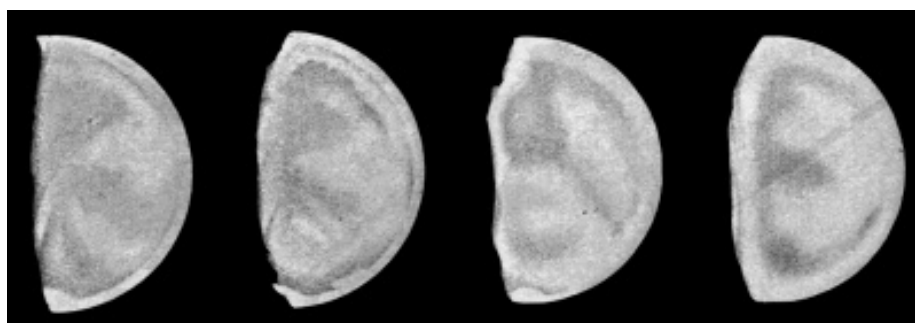

Chart of All the Visible Surface of Mercury (Lowell)

the sunward hemisphere turned toward us has been repeatedly drawn during the last 250 years. Only dull, indefinite markings, or spots covering large areas have, however, been seen until recently. The illustration below shows the general nature of markings drawn by the earlier observers. Frequently the terminator was irregularly curved, indicating mountains of great height; and polar caps were depicted. According to recent observations of Lowell, however, the disk of Venus is colorless, and resembles 'simply a design in black and white over which is drawn a brilliant straw-colored veil.' This

veil is doubtless the planet's atmosphere. No polar caps were seen.



Venus as drawn by Mascari in 1892

Markings on the disk, seen and drawn independently by Lowell and his assistants, Douglass, See, and others, are broad belts, not spots. Three specimen drawings are adjacent.

The markings are mostly great circles on the planet's surface, and many of them radiate from a single center, as the accompanying chart shows. They partake of the general brilliance of the disk, and their lack of contrast renders them difficult objects, except to observers trained in visualizing faint planetary detail. Three slight protuberances, perhaps mountains, were detected on the terminator. Although these



Venus as drawn by Lowell in 1896

observations were made in the steady air of Flagstaff, Arizona, there is reason

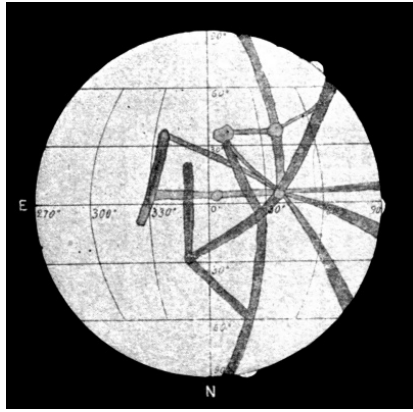
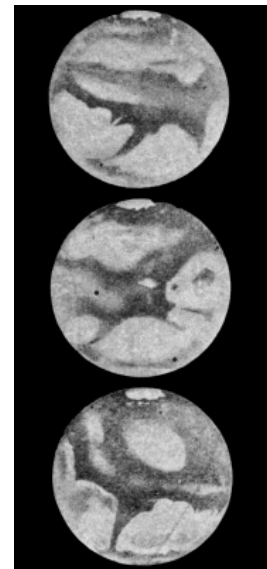

Chart of Visible Hemisphere of
Venus (Lowell)

for doubting the reality of such elusive markings, and many astronomers regard them as optical illusions purely, to be explained by principles of physiological optics. Their existence cannot be accepted as fact until fully confirmed by observers in other parts of the world. Taken in connection with the practical certainty of an atmosphere, the constant aspect of one hemisphere perpetually toward the sun is very significant; probably atmospheric currents would gradually remove all water and nearly all moisture from the sunward hemisphere, and deposit it as ice on the dark side of the planet. This affords a likely explanation of the so-called phosphorescence of the dark

hemisphere; for a faint light diffused over the unilluminated portion of the disk has repeatedly been seen by many good observers.

Surface of Mars in General.—Huygens, in 1659, made the first sketch of Mars to show definite markings; and in 1840, Beer and Maedler drew the first chart of the planet. The two hemispheres exhibit a marked difference in brightness, the northern being much brighter. Probably it is land, while the southern is mainly water; but in general there is no analogy with the present scattering of land and water on the earth. Four to eleven is the proportion here; but on Mars land somewhat predominates. Probably the waters have for the most part slight depth. Extensive regions which change from yellow, like continents, to dark brown, are thought to be marshes, varying depth of water causing the diversity of color. Mars appears to be so far advanced in his life history that areas of permanent water are very limited. The border of the disk is brighter than the interior, and changes in apparent brightness of certain regions are well established. In considerable part these depend upon the angle of vision as modified by axial turning of the planet. Photographs of Mars have been taken, but they show only salient features of the disk. Markings of Syrtis Major, a well-



Mars in 1877 (Green)

known region (see fifth figure on page 315) appear to be vegetation rather than water. Smoothness of the terminator, along which a few projections and flattenings have been observed, indicates clearly that the Martian surface is relatively flat, as compared with the present rugged exterior of earth and moon.

Orbits of Earth and Mars.—Inner circle in next illustration represents orbit of earth, and outer one orbit of Mars eccentrically placed in true proportion. Around inner circle are indicated positions of earth in different months, and around outer circle are shown the points occupied by Mars at opposition time in the several years indicated. The most favorable opposition of Mars, or when that planet is at the minimum distance of 35,000,000 miles from the earth, can take place only in August and September, as indicated on right-hand side of diagram. Similarly on left-hand side the least favorable oppositions occur in those years

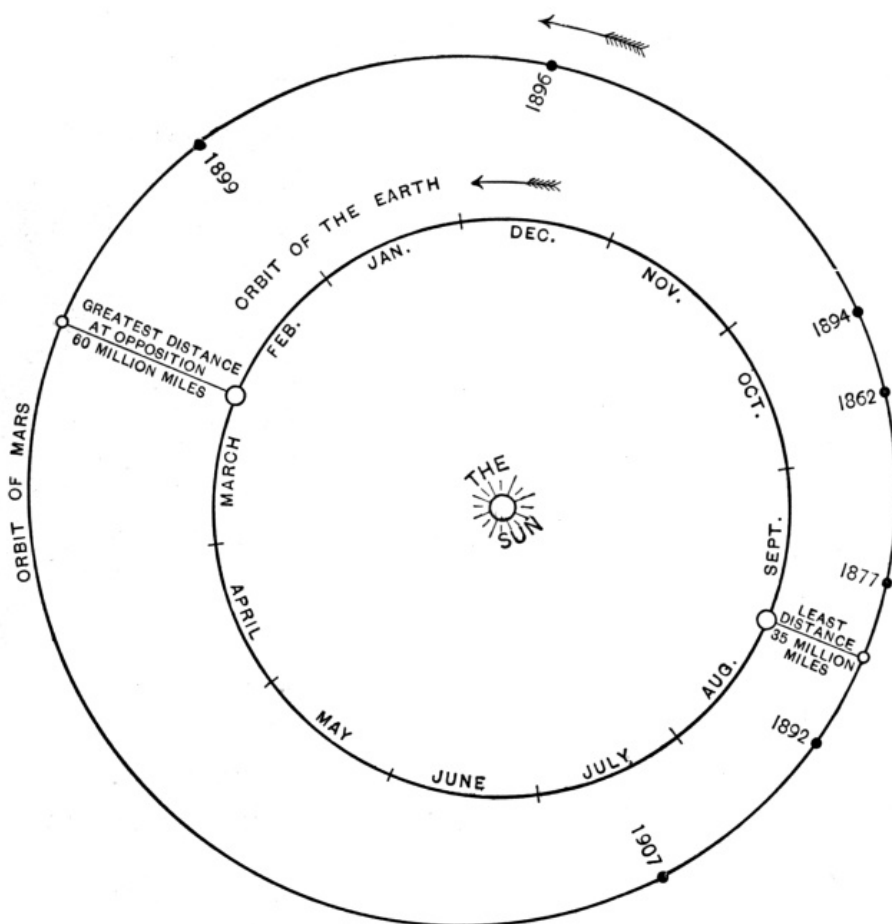

Orbits of Mars and Earth, showing Least and Greatest Distances at Opposition

when the opposition time falls in February and March. Exact positions of Mars at recent favorable oppositions are shown at 1877 and 1892. But at opposition, October, 1894, although the planet was then much farther from earth, still he culminated higher than in 1892; because the sun crosses the meridian lower in October than in August. Higher northern declination enabled the planet to be observed to greater advantage in 1894 than in 1892, because nearly all the observatories of the world are located in its northern hemisphere. Subsequent favorable oppositions of Mars are July 1907, September 1909, and August 1924. The last occurs very near the same position as 1892.

Polar Caps of Mars.—These were discovered by Cassini in 1666. Rather more than a century later, Sir William Herschel first made out their variation in size with progress of the seasons on Mars, which are in general similar to ours, although longer, because the Arean year is longer. Near the end of Martian winter the polar caps are largest, and they gradually shrink in size till the end of summer.

This remarkable diminution of the south polar cap has been repeatedly observed since Herschel's time, and the illustrations show its progress during the Martian spring and summer of 1894. Without much doubt, this shrinking of the polar cap is due to melting of snow and ice. But Stoney, arguing upon principles outlined on page 216, concludes that water cannot remain on Mars; that his atmosphere is mainly nitrogen and argon, with carbon dioxide, distillation of the vapor of which toward the poles alternately may perhaps account for the phenomena of the caps. The north polar cap covers the planet's pole of rotation almost exactly; but the center of the south is now displaced about 200 miles from the true pole, and this distance varies irregularly from time to time. At the beginning of the summer season of 1892, the south polar cap was 1200 miles in diameter; gradually a long, dark line appeared near the middle, and eventually cut the cap in two; the edge became notched; dark spots grew in its central regions, and isolated patches were seen to separate from the principal mass, and later dissolve and disappear. The phenomenon was similar in 1894, as Barnard's 12 pictures of the cap show (page 316). In three months the cap's diameter had shrunk to 170 miles, and in eight months it had vanished entirely.

Canals and Oases of Mars.—This diminution of the polar cap seems to afford a key to the physiographic situation on Mars; for, coincidentally with its shrinking, a strange system of markings begins to develop, traversing continental areas in all directions, and forming a network of darkish narrow lines.

Six engravings on the next page exhibit the planet's surface in all longitudes, and show the canals much intensified. All appear on the flat disk as either straight or uniformly curving lines; and if transferred to the surface of a globe,

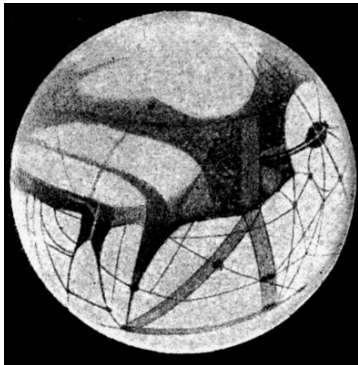

(a) Top of Fork on left is Fastigium Aryn. Dark Horn nearly central is Margaritifer Sinus

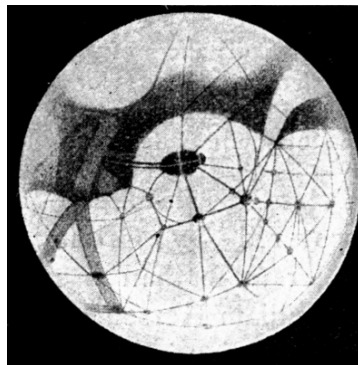

(b) Solis Lacus is nearly central. Double Nectar runs to the left from it

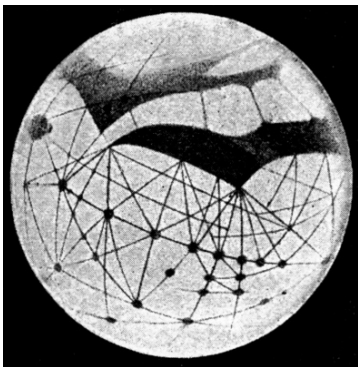

(c) Seven Canals diverge from Sinus Titanum. Eumenides-Orcus threads Nine Oases

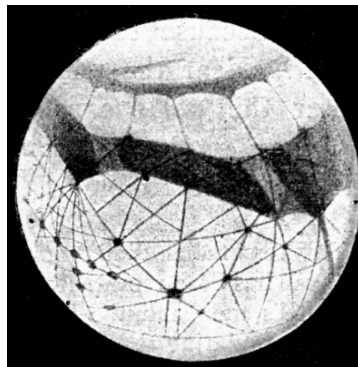

(d) The Rectangle is Trivium Charontis. Dark Mare Cimmerium is central.

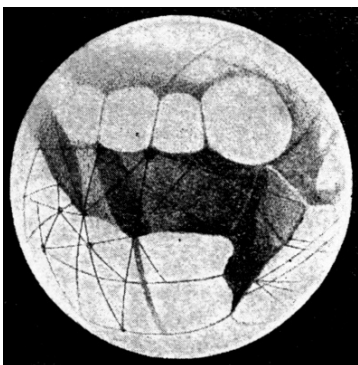

(e) Largest Roundish Area is Hellas. Below Hellas is the pointed Syrtis Major

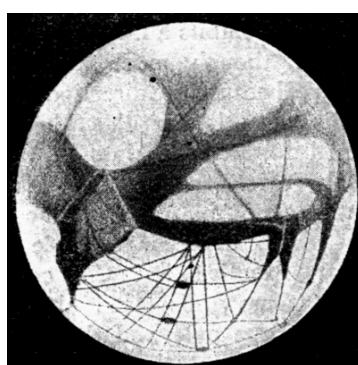

(f) Among Double Canals are Euphrates (nearly vertical), and Asopus perpendicular to it

Mars according to Schiaparelli and Lowell (1877-1894)

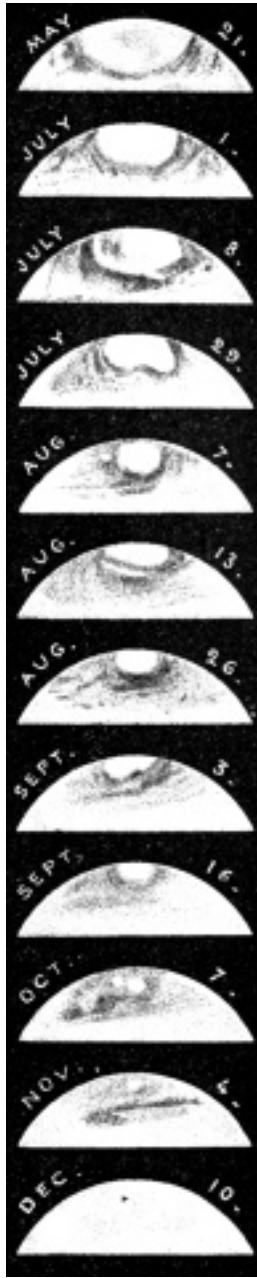

Shrinkage and
Disappearance of South
Polar Cap in 1894
(Barnard in *Popular
Astronomy*)

they are found to traverse it on arcs of great circles. Many canals connect with projections of bluish-green regions, which may be actual gulfs and bays. At numerous intersections with other canals are oval or circular spots, called oases, many of them appearing like hubs from which canals radiate as spokes. Their average diameter is about 130 miles. For example, seven canals converge to Lacus Phoenicis. The most signal marking of this character is in Arean latitude about 30° south (shown above middle of the second disk opposite). Though often called the 'oculus,' or eye of Mars, it is now generally known as Solis Lacus, or Lake of the Sun. Its breadth is 300 miles, and its length 540 miles. Through Solis Lacus run narrow double canals, whose length is much less than the average. In general the canals average about 1200 miles; but the longest one is Eumenides-Orcus, whose combined length is 3500 miles, or nearly equal to the entire diameter of the planet. Length enhances their visibility, for the average width is only about 30 miles. Canals were first discovered by Schiaparelli in 1877. They are bluish-green in color, and have been repeatedly observed by their discoverer in Italy; Lowell, in Arizona; Perrotin, in France; W. H. Pickering, in South America; astronomers of the Lick Observatory; Wilson, in Minnesota; and Williams, in England. About 200 have been seen in all. But a steady atmosphere is requisite to reveal them. Photography has certified the actual existence of some of the canals.

Doubling of the Canals and Oases.—Lowell thus describes this marvelous phenomenon:—

'Upon a part of the disk where up to that time a single canal has been visible, of a sudden, some night, in place of the single canals, are perceived twin canals,—as like, indeed, as twins, if not more so, running side by side the whole length of the original canal, usually for upwards of a thousand miles, of the same size throughout, and absolutely parallel to each other. The pair may best be likened to the twin rails of a railroad track. The regularity of the thing is startling.'

Many double canals are shown in the sixth figure on page 315. Average distance between the twin canals is 150 to 200 miles. This phenomenon, still a mystery,

does not appear to be an effect of either optical illusion or double refraction; but rather a really double existence, seen only under exceptionally favorable conditions of atmosphere. More strangely still, the oases too are occasionally seen to be double.

Meaning of Canal and Oasis.—It is the design of physical science not only to record but to explain appearances; and the canals, whether double or single, have, to many astronomers who have seen them, a look of artificiality rather than naturalness. If we accept the former, the explanation of the canals themselves, advanced by W. H. Pickering and reinforced by the argument of Lowell, seems very plausible: water is scarce on the planet; with melting of the polar caps, it is gradually conducted along narrow channels through the middle of the canals, thereby irrigating areas of great breadth which, with the advance of the season, become clothed with vegetation. Similarly the oases; and at our great distance, it is vegetation which, although invisible in the Aerean winter, grows visible as canal and oasis with every return of spring. The fact that oases are seen only at junctions of canals, and not elsewhere, greatly strengthens this argument. Of course, acceptance of this theory implies that Mars in ages past, has been, and may be still, peopled by intelligent beings; and that continuation of their existence upon that planet, during secular dissipation of natural water supply, has rendered extensive irrigation a prime requisite. For animal life, of types known to us, is dependent upon vegetable life; which, in turn is conditional upon water distribution, either natural or artificial. But only by long continued observation of the behavior of canal and oasis in both hemispheres of Mars, can we hope for a rational solution of the question of life in another world than ours. In 1905 Molesworth published many fine observations of detail on the surface of Mars, made in the highly favorable atmosphere of Ceylon.

Seasonal Changes.—Striking seasonal changes seen to keep step with progress of Mars in his orbit, are best exhibited by direct comparison between drawings at intervals of several months. Three such are chosen in Figure 13.40. The region known as Hesperia is central in all. The first, 7th June, 1894, corresponds to early spring on Mars. South polar snows have just begun to melt. Everywhere encircling it is the dark area, as if water from the melting of the cap; for this band follows the cap as it shrinks, becoming less in width as the cap grows smaller. This is shown in the middle disk, which corresponds to early summer. Mark the other changes in the disk: (1) the general thinning out of dark areas which on the actual planet are greenish-blue; (2) the increase in intensity of reddish ochre regions through the southern hemisphere, as if the water had in considerable part evaporated, Hesperia already beginning to show as an oblique, V-shaped, reddish marking in the center of the disk; (3) progress in development of canals, though not as yet far advanced. As the planet

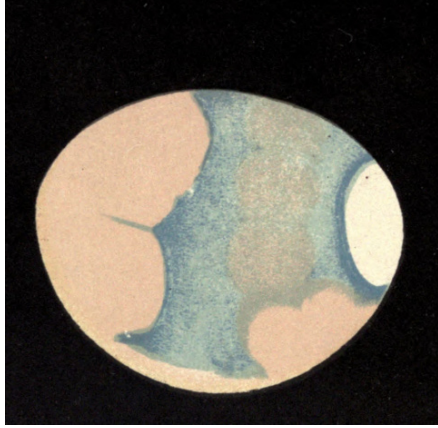

Early Spring.

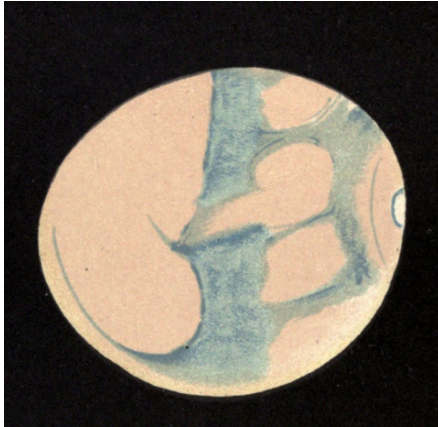

Early Summer.

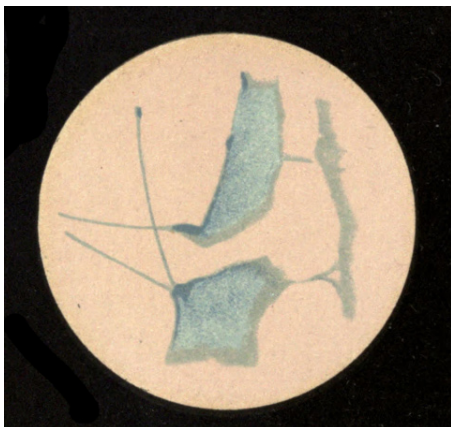

Late Summer.

THE PLANET MARS, three views, showing changing seasons of Hesperia (*from original drawings by Lowell*).

approaches late summer, in the third drawing, Hesperia has become a broad cleft through the water area, three canals are particularly well developed in the northern hemisphere, and the south polar cap has practically vanished. In other longitudes like changes went on simultaneously, and in the same significant and seemingly obvious direction.

Discoveries of Small Planets.—In 1800, the closing year of the eighteenth century, conspicuous absence of a planet between Mars and Jupiter as required by Bode's law, led to an association of 24 astronomers intent upon search for the missing body. Piazzi of Sicily inaugurated the long list of discoveries by finding the first one on the first night of the 19th century (1st January, 1801). He called it Ceres, that being the name of the tutelary divinity of Sicily. Three others, named Pallas, Juno, and Vesta, were found by 1807, but the fifth was not discovered till 1845.

Since 1847 no year has failed to add at least one to the number, and in 1892 the increase was 28. The total number is now more than 600. Of these, 80 were discovered in the United States, mainly by Peters (48) at Clinton, New York, and Watson (22) at Ann Arbor, Michigan. Palisa, of Vienna, found no less than 84. In 1891, Wolf of Heidelberg inaugurated discoveries of these bodies by the aid of photography, and he has discovered over 100 in this manner: a sensitive plate exposed for two or three hours to a suspected region of sky makes a permanent record of all the stars as round disks, and of any small planets as short trails because of their apparent motion during exposure. So they are discovered about 20-fold more readily than by the old-fashioned method at the eyepiece of a telescope. Charlois of Nice has found over 100 small planets by photography. Many of the more recent discoveries are yet without names, and are designated by their number, thus (331); also by a double letter and year of discovery, as 1897 DE = (428). Probably there are hundreds more, and possibly thousands. Discoveries are disseminated by Gerrish's international code.

Orbits and Origin of Small Planets.—The orbits of small planets, although linked together inseparably, still present wide degrees of divergence. They are by no means evenly distributed: in those regions of the zone where a simple relation of commensurability exists between the appropriate period of revolution and the periodic time of Jupiter, gaps are found, resembling those shown farther on as existing in the ring of Saturn.

Especially is this true for distances corresponding to one half and one third of Jupiter's period. Not only are the orbits of small planets far from concentric, but they are inclined at exceptionally large angles to the ecliptic, that of Pallas (2) being 35° . Several groups exist having a near identity of orbits, one such group including 11 members. Polyhymnia (51) is much perturbed by the attraction of Jupiter, and its motion has recently been employed by Newcomb in finding

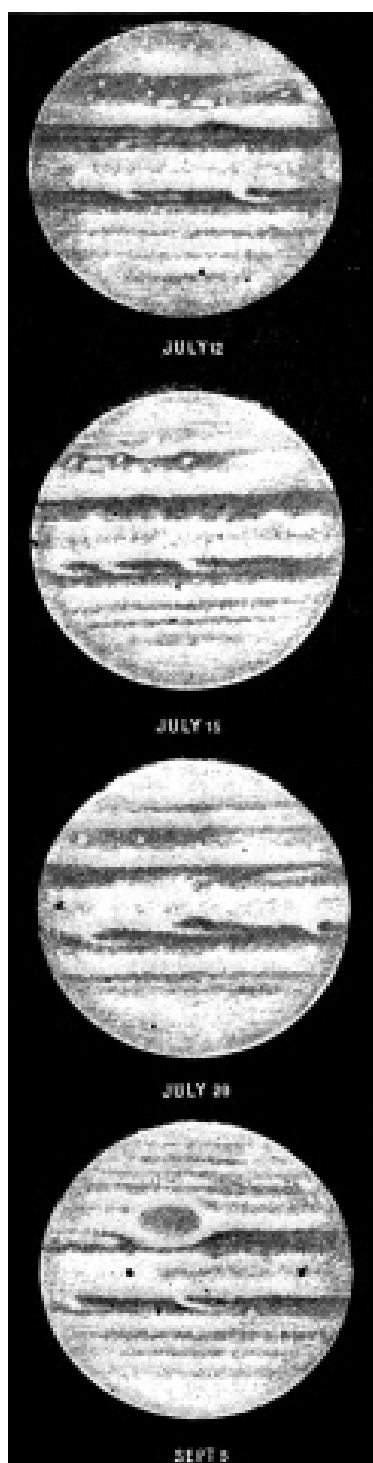

Jupiter in 1889 (Keeler)

anew the mass of the giant planet, equal to $\frac{1}{1047.35}$ that of the sun. Victoria (12), Sappho (80), and others, on account of favorable approach to the earth, have been very serviceable in the hands of Gill and Elkin in helping to ascertain sun's distance from earth. Data concerning orbits of these bodies are published each year in the *Berliner Astronomisches Jahrbuch*.

Olbers early originated the theory, now disproved, that small planets had their origin in explosion of a single great planet. Most probably, however, proximity of so massive a planet as Jupiter is responsible for the existence of a multitude of small bodies in lieu of one larger one; for his gravitative action upon the ring in its early formative stage, in accordance with principles of the evolution of planets, may readily have precluded ultimate condensation of the ring into a separate planet.

Surface of Jupiter.—In a telescope of even moderate size, Jupiter appears, as in this typical view, striped with many light and dark belts, of varying colors and widths, lying across the disk parallel to each other and to his equator, or nearly so. They always appear practically straight because the plane of Jupiter's equator always passes very nearly through the earth. The belts are not difficult to see; but the telescope had been invented 20 years before they were discovered, at Rome, in 1630. Usually the equatorial zone, about 25° broad, is lightest in hue, and almost centrally through it runs a very narrow dark stripe. Larger telescopes reveal a variety of spots and streaks in this zone, and permanence of markings is rather the exception than the rule. It appears to be a region of great physical com-

motion. Bordering this zone, on either side, are usually two broad reddish belts, about 20° of latitude in width. These are zones of little disturbance, but the southern one often appears divided. Just beyond it is the 'great red spot.' Here and there white cloudlike masses, near the edge of the equatorial zone, appear to flow over into the red belts as long oblique streamers, seemingly dividing these broad zones into two or three narrow stripes. Farther from the equator are still other belts, growing narrower as the poles are approached, because curvature of the spherical surface foreshortens them; and all around the limb, whether at poles or equator, the belts fade into indistinctness. Color and intensity of the principal belts are by no means constant, their hue being at times brownish, copper-colored, and purple. Of the two hemispheres, the reddish tint of the southern is rather more pronounced.

Jupiter's Great Red Spot.—Probably this gigantic marking, whose area exceeds that of our whole earth, has long been forming; for although it was not certainly seen until 1869, and still more definitely in 1878 first by Pritchett, there are indications that Cassini, at Paris, observed it in 1685.

The illustrations on this page show its appearance in 1881 and 1885. Breadth of this elliptic marking was about 8000 miles, and length 30,000. The great red spot has not been uniformly conspicuous, for it nearly faded out in 1883–84. The year following a white cloud appeared to cover the middle, making it look like a chain-link. The lowest drawing (page 320) shows its appearance in 1889. Now quite invisible, it may have a periodicity, and again reappear. Cloud markings near it have been observed to be strikingly repelled. If the spot remained stationary upon the planet's surface, it might be simply a vast fissure in the outer atmospheric envelope of Jupiter, through which are seen dense red vapors of interior strata, if not the planet's true surface; but its slow drift precludes this theory. No satisfactory explanation of the great red spot has yet been advanced.

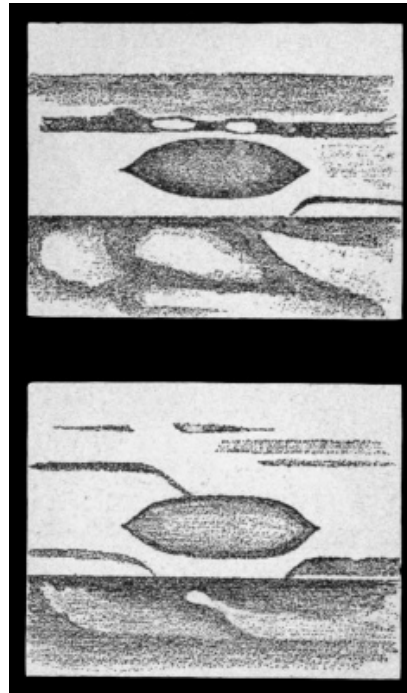

Jupiter's Great Red Spot in 1881
and 1885 (Denning)

A Chart of Jupiter.—Notwithstanding considerable variations in detailed appearance of Jupiter's disk, many larger markings present a sufficient perma-

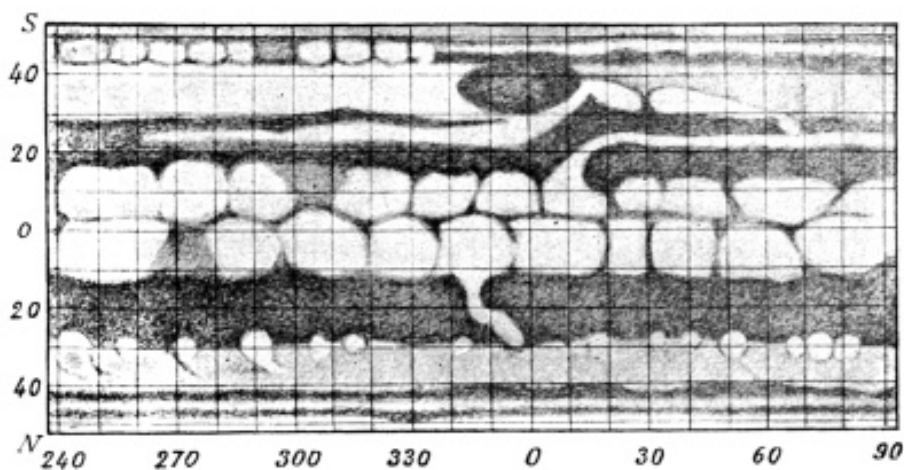

Approximate Chart of a Portion of Jupiter in 1895 (Henderson)

nence from month to month to admit of charting. Such a chart is on the current page, on the Mercator projection, and intended to be accurate as to general features only. Center of the great red spot is taken as origin of longitudes. The principal belts and the more important white spots are clearly indicated. From the construction of many such charts, at intervals of about a year, much can be learned about the planet's atmosphere, present physical condition, and future development. As yet photography, successfully applied by Common, and Russell, and at the Lick Observatory, although showing accurately a great quantity of detail, including a multitude of white and dark spots, does not equal the eye in recording finer markings. Length of exposure and unsteadiness of atmosphere are the chief obstacles. Hough in America and Williams in England have been constant students of Jupiter.

Surface of Saturn.—A telescope of only two inches' aperture will show the ring of Saturn, also Titan, his largest satellite. A four-inch object glass will reveal four other satellites on favorable occasions. The entire disk appears as if enveloped in a thin, faint, yellowish veil. At irregular intervals belts are seen similar to Jupiter's; but they do not persist so long, and are much fainter. As a rule Saturn's equatorial belt is his brightest region, and an olive-green zone often caps the pole. Excellent photographs have been taken at the Lick and Greenwich Observatories.

At intervals of nearly 15 years, the belts appear very much curved, as in the illustration above; because the earth is then about 26° above or below the

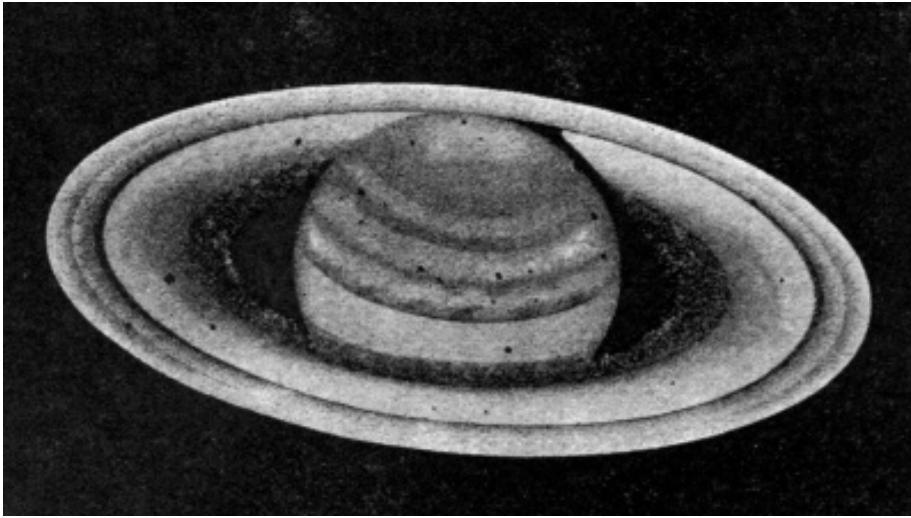

Saturn and his Rings (drawn by Pratt in 1884)

plane of the planet's equator, this being the angle by which the axis of Saturn is inclined to a perpendicular to its orbit plane. Midway between these epochs, the belts appear practically curveless, like Jupiter's, because the plane of Saturn's equator is then passing near the earth (see drawing opposite on the right). Few bright spots and irregularities of marking characterize this planet, and his true period of rotation is on that account difficult to ascertain. Celestial photography is not yet sufficiently perfected to afford much assistance in recording the minute

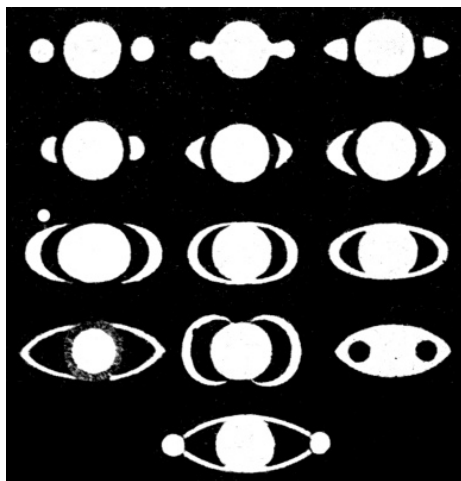

Very Early Drawings of Saturn (in the 17th Century)

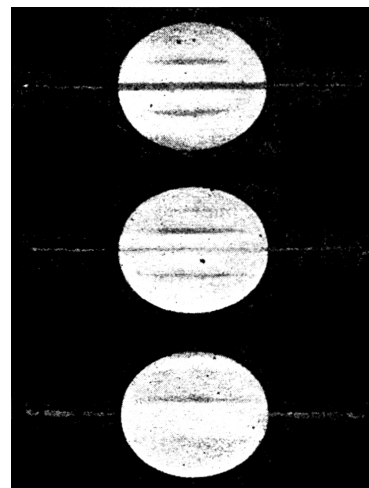

Saturn in 1891. (Mark the Excessive Polar Flattening)

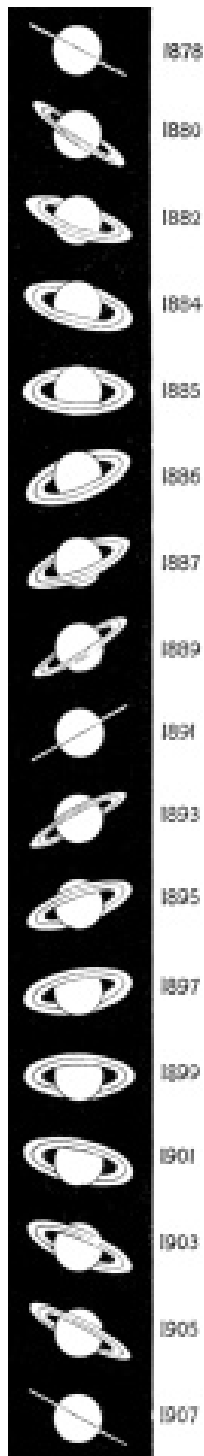

Phases of the Ring of
Saturn

details of so small a disk as Saturn's. With the invention of more highly sensitive plates, requiring a much shorter exposure, unavoidable blurring of atmosphere will be less harmful. Numerous faint and nearly circular dark and white spots or mottlings were observed on the ball in 1896.

Saturn's Rings and their Phases.—Saturn is surrounded by a series of thin, circular plane rings which generally appear elliptical in form. To astronomers of the first half of the 17th century, Saturn afforded much puzzlement, and they drew the planet in a variety of fanciful forms, some of which are here shown. Huygens first guessed the riddle of the rings in 1655. When widely open, as in 1884 (on the preceding page), and in 1899 and 1914, a keen-eyed observer, even with a small telescope, can see faint, darkish lines or markings near the middle of the ring. These are divisions of the system, and there are three complete rings; (*A*) outer bright ring, (*B*) inner bright ring, (*C*) innermost or crape ring.

While Saturn moves round the sun, the ring maintains its own plane constant in direction, just as earth's equator remains parallel to itself. Consequently the plane of Saturn's rings sometimes passes through the earth, sometimes through the sun, and again between earth and sun. At these times the rings of Saturn actually disappear from view, or nearly so, as just illustrated. In the first case, the ring is so thin that it cannot be seen when the earth is exactly in the plane of it. In the second, the ring disappears because the sun is shining on neither side of it, but only on its edge. The ring may disappear in the third instance when earth and sun are on opposite sides of it, and therefore only the unilluminated face of the ring is turned toward us. Disappearances due to these causes take place about every 15 years, or one half the periodic time of Saturn, the next occurring in 1921, as the adjacent figures (for inverting telescopes) show. Intervals between disappearances are unequal partly because of eccentricity of

Saturn's orbit, perihelion occurring in 1915 and aphelion in 1929.

Size and Constitution of the Rings.—The dimensions of the ring system are enormous, especially in comparison with its thickness, which cannot exceed 100 miles. Seen edge on, it has the appearance of a fine and often broken hair line (page 323).

Outer diameter of outside ring is 173,000 miles, and its breadth, 11,500 miles. Then comes the division between the two luminous rings, discovered by Cassini in 1676: its breadth is 2400 miles. Outer diameter of inner bright ring is 145,000 miles, and its breadth, 17,500 miles. Next, the innermost or dusky ring, discovered by Bond in 1850: its inner diameter is 90,000 miles, and its breadth 10,000 miles; and it joins on the inner bright ring without any apparent division. So gauzy is it that the ball of Saturn can be seen directly through it, except at the outer edge. Characteristic of the inner bright ring is a thickening of its outer edge,—much the brightest zone of the ring system. The rings of Saturn are neither solid nor liquid, but are composed of enormous clouds or shoals of very small bodies, possibly meteoric, traveling round the planet, each in an orbit of its own, as if a satellite. Perhaps they are thousands of miles apart in space; but so distant is the planet from the earth and so numerous are the particles that they present the appearance of a continuous solid ring. Keeler has demonstrated by the spectroscope this theory of the constitution of Saturn's rings, showing that inner particles move round the primary more swiftly than outer ones do, in accord with Kepler's third law. The periodic time of innermost particles is 5 h. 50m., or but little more than half the rotation time of the ball itself, which, according to some observers, is slightly displaced from the center of the rings. Not impossibly the ring system is a transient feature, and may be another satellite in process of formation (page 406).

Surface of Uranus and Neptune.—The great planet Uranus, the first one ever found with the telescope, was discovered by Sir William Herschel, 13th March, 1781. Calculation backward showed that this planet had been observed about 20 times during the century preceding, and mistaken for a fixed star. So remote is Uranus and so small the apparent disk that very few observers have been able to detect anything whatever on his pale green surface. Some have seen belts resembling those on Jupiter, others a white spot from which a rotation period equal to 10 hours was found. More recently the planet has been sketched by Brenner, from the clear skies of Istria, and six of his drawings are reproduced on the next page. The markings appear neither numerous nor definite. If so little is found upon Uranus, vastly less must be expected from Neptune, and no marking whatever has yet been certainly glimpsed.

The Discovery of Neptune.—The discovery of Neptune was a double one. Early in the nineteenth century it was found that Uranus was straying

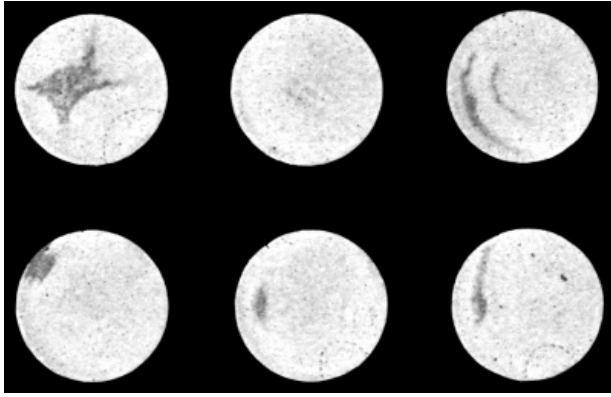

Uranus in 1896 (Brenner)

widely from his theoretic positions, and the cause of this deviation was for a long time unsuspected. Two young astronomers, Adams in England, and Le Verrier in France, the former in 1843 and the latter in 1845, undertook to find out the cause of this perturbation, on the supposition of an undiscovered planet beyond Uranus. Adams reached his result first, and English astronomers began to search

for the suspected planet with their telescopes, by first making a careful map of all the stars in that part of the sky. But Le Verrier, on reaching the conclusion of his search, sent his result to the Berlin observatory, where it chanced that an accurate map had just been formed of all stars in the suspected region. On comparing this with the sky, the new planet, afterward called Neptune, was at once discovered, 23d September, 1846. It was soon found that Neptune, too, had been seen several times during the previous half century, and recorded as a fixed star. The tiny disk, however, is readily distinguishable from the stars around it, if a magnifying power of at least 200 diameters can be used. There are theoretic reasons for suspecting the existence of two planets exterior to Neptune; but no such bodies have yet been discovered, although search for them has been conducted both optically and by means of photography.

Chapter XIV

The Argument for Universal Gravitation

So striking a confirmation of Newton's law was afforded by the discovery of Neptune, and so completely does the universality of that law account for the motions of the heavenly bodies, and the variety of their physical phenomena, that the present chapter is devoted to a partial outline sketch of the argument for universal gravitation.

From Kepler to Newton.—The great progress made by Kepler in dealing with the motions of the planets had not in any proper sense explained those motions; for his three famous laws merely state *how* the planets move, without at all touching the reason *why* these laws of their motion are true. Before this question could be answered, the fundamental principles of physics, or natural philosophy as it was called in his day, had to be more fully understood. These principles concern the state of bodies at rest and in motion. Meaning of the term *rest* is relative, and absolute rest is undefinable. Motion is a change of place; and absolute rest is a state of absence of motion. Galileo early in the 17th century was the first philosopher who ascertained the laws of motion and wrote them down. But as they were better formulated by Newton, his name is always attached to them. They are axioms, an axiom being a proposition whose truth is at once acknowledged by everybody, as soon as terms expressing it are clearly understood. Newton, indeed, in his great work entitled the *Principia*, or principles of natural philosophy, called these laws *Axiomata, sive Leges Motûs*. Antecedent to proper conception of Newton's law of universal gravitation must come an understanding of the three fundamental laws of motion.

Newton's First Law of Motion.—The first law reads as follows: Every body continues in its state of rest or of uniform motion in a straight line, except in so far as it may be compelled by force to change that state. Newton asserts in this law the physical truth that a state of uniform motion

is just as natural as a state of rest. To one who has never thought about such things, this is at first very difficult to realize; because rest seems the natural state, and motion an enforced one. But difficulty is at once dispelled, as soon as one begins to inquire into the causes that stop any body artificially set in motion.

A baseball rolling upon a level field soon stops because, in moving forward, it must repeatedly rise against the attraction of gravity, in order to pass over minor obstacles, as grass and pebbles. Also there is much surface friction. A rifle shot soon stops because resistance of the air continually lessens its speed, and finally gravity draws it down upon the earth. A vigorous winter game common in Scotland is called curling. The curling stone is a smooth, heavy stone, shaped like a much-flattened orange, and with a bent handle on top. When curling stones are sent sliding on smooth ice as swiftly as possible, they go for long distances with but slight reduction of speed, thus affording an excellent approximation to Newton's first law. But a perfect illustration is not possible here on the earth. If it were practicable to project a rifle shot into space very remote from the solar system, it would travel in a straight path for indefinite ages, because no atmosphere would resist its progress, and there is no known celestial body whose attraction would draw it from that path.

Newton's Second Law of Motion.—The second law reads: Change of motion is proportional to force applied, and takes place in the direction of the straight line in which the force acts.

This law is easy to illustrate without any apparatus. Throw a stone or other object horizontally. Everybody knows that its path speedily begins to curve downward, and it falls to the ground. From the smooth and level top of a table or shelf, brush a coin or other small object off swiftly with one hand: it will fall freely to the floor a few feet away. Repeat until you find the strength of impulse necessary to send it a distance of about two feet, then four, then six feet, as in the picture. With the other hand, practice dropping a coin from the level of the table, so that it will not turn in falling, but will remain nearly horizontal till it strikes the floor. Now try these experiments with both hands together, and at the same time. Repeat until one coin is released from the fingers at the exact instant the other is brushed off the table. Then you will find that both reach the floor at precisely the same time; and this will be true, whether the first coin is projected to a distance of two feet, four feet, six feet, or whatever the distance. Had gravity not been acting, the first coin would have traveled horizontally on a level with the desk, and would have reached a distance of two feet, or four feet, proportioned to the impulse. What the second law of motion asserts is this: that the constant force (gravity in this case) pulls the first coin just as far from the place it would have reached, had gravity not been acting, as the same force,



Illustrating Newton's Second Law of Motion

acting vertically and alone, would in an equal time draw it from the state of rest. Whatever distance the coin is projected, the 'change of motion' is always the vertical distance between the level of table and floor, that is, 'in the direction of the straight line in which the force acts.' The law holds good just the same, if the coin is not projected horizontally, provided the floor (or whatever the coin falls on) is parallel to the surface from which it is projected.

Newton's Third Law of Motion.—The third law reads: To every action there is always an equal and contrary reaction; or the mutual actions of any two bodies are always equal and oppositely directed. This law completes the steps necessary for an introduction to the single law of universal gravitation, because it deals with mutual actions between two bodies, or among a system of bodies, such as we see the solar system actually to be.

To illustrate in Newton's own words: 'If you press a stone with your finger, the finger is also pressed by the stone. And if a horse draws a stone tied to a rope, the horse (if I may so say) will be equally drawn back toward the stone; for the stretched rope, in one and the same endeavor to relax or unstretch itself, draws the horse as much toward the stone as it draws the stone toward the horse.' Action and reaction are always equal and opposite.

So when one body attracts another from a distance, the second body

attracts with an equal force, but oppositely directed. If there were two equal, and therefore balanced, forces acting on but one body, that would be in equilibrium; but the two forces specified in this third law act on two different bodies, neither of which is in equilibrium. Always there are two bodies and two forces acting, and one force acts on each body. To have a single force is impossible. There must be, and always is, a pair of forces equal and opposite. Horse and stone advance as a unit, because the muscular power of the horse exerted upon the ground exceeds the resistance of the stone.

Transition to the Law of Gravitation.—Having clearly apprehended the meaning of Newton's three laws of motion, transition to his law of universal gravitation is easy. The laws of motion, however, must not now be thought of separately, but all as applying together and at the same time. First, consider the earth in its orbit. Our globe has a certain velocity as it goes round the sun; it would go on forever in space in a straight line, with that same velocity, except that some deflecting force draws it away from that line. This change of motion or direction from a straight line must be proportional to the force producing it, and the change itself must indicate direction in which the force acts; also, if there is a force acting from the sun upon the earth, there must be an equal and oppositely directed force from the earth upon the sun, for action and reaction are equal.

Similarly the motion of other planets round the sun; and Newton's reasoning and mathematical calculations, based on the laws of Kepler, made it perfectly clear that planetary motions might be dependent upon a central force directed toward the sun, the intensity of this force growing less and less in exact proportion as the square of the planet's distance grows greater: thus at twice the distance the intensity is but one fourth as great. By making this single hypothesis, the meaning of all three laws of Kepler was perfectly apparent. But could the action of any such force be proved? If it could, the motions of all the satellites round their primaries might be accounted for by supposing a like force emanating from the central planets. This would mean, too, that the moon must move round us obedient to a force directed toward the earth, but decreasing in intensity just as rapidly as square of moon's distance from our center increases. Can it be that the common attraction of gravity which draws stones and apples downward is a force answering to this description? Why should it attract only common objects near at hand? Why may not the realm of this mysterious force extend to the moon? To the calculation of this problem, Newton next addressed himself.

Gravitation holds the Moon in her Orbit.—If gravity causes the apple to fall from the tree, the bird when shot to fall to the ground, and

hail to descend from the clouds, certainly it is possible, thought Newton, that it may hold the moon in her orbit, by continually bending her path round the earth. If so, the moon must perpetually be falling from the straight line in which she would travel, were the central force not acting. Force can be measured by the change of place it produces. At the surface of the earth, about 4000 miles from the center of attraction, bodies fall 16.1 feet in the first second of time. But our satellite is 240,000 miles away, or 60 times more distant. So the moon, if held by the same attraction, only diminishing exactly as the square of the distance increases, should fall away from a straight line

$$\frac{1}{(60 \times 60)} \text{ of } 16.1 \text{ feet;}$$

that is, $\frac{1}{20}$ of an inch. Newton calculated how much the moon actually does curve away from a tangent to her orbit in one second, and he found it to be precisely that amount (page 211). So the law of gravitation was immediately established for the moon; and Newton's subsequent work showed that it explained equally well the motion of the satellites of Jupiter round their primary, and the motion of earth and all other planets round the sun. He found, in fact, that the force acting depends, in each case, on the product of the masses of the two bodies, and on the square of the distance between them.

Law of Gravitation extends also to the Planets.—Newton by no means considered his law of gravitation established, just because it explained the motion of the moon round the earth. If the law is universal, it must completely account for the movements of all known bodies of the solar system as well. Since the planets travel round the sun as the moon does round the earth, a force directed toward the sun must continually be acting upon them. Is not this the force of gravitation? Recall Kepler's third law. Newton's calculations from it proved that the planets fall toward the sun in one second of time through a space which is less for each planet in exact proportion as the square of its distance from the sun is greater. Also Kepler's second law: if the attracting force emanates from the sun, the planet's radius vector will pass over equal areas in equal times. On the other hand, it cannot pass over equal areas in equal times, if the center of attraction resides in any direction but that of the sun. So Kepler's second law shows that the force which attracts the planets is directed toward the sun.

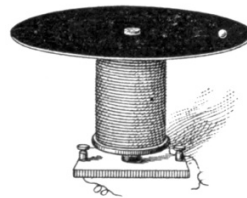

Apparatus to illustrate
Curvilinear Motion

What chance for farther doubt that this force is the attraction of gravitation of the sun himself? The farther Newton's investigations were pushed, the more striking the confirmation of his theory. Historically, the three laws of Kepler expressed the bare facts of planetary motion, and formed the basis upon which Newton built his law of universal gravitation. But once this general law was established, it was seen that Kepler's laws were immediate consequences of the Newtonian law,—merely special cases of the general proposition.

Curvilinear Motion due to a Central Attracting Force.—A facile form of apparatus will help to make clear the motion of a body in arcs of conic sections under influence of a central attracting force, and to impress it upon the mind. A glass plate about 18 inches in diameter is leveled (on the preceding page); and through a central hole projects the conical pole-piece of a large electro-magnet. Smoke the upper face of the glass plate evenly with lampblack. Connect battery circuit, and the apparatus is ready for experiment. Project repeatedly across the

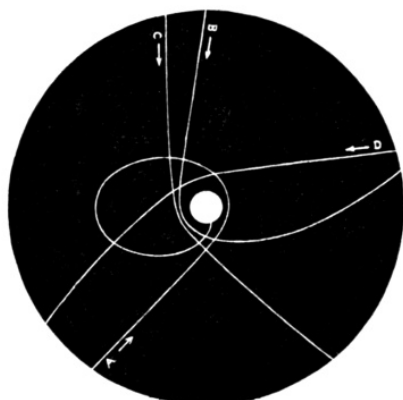

Experimental Orbits actually obtained with this Apparatus

plate at different velocities a small bicycle ball of polished steel, aimed a little to one side of the pole-piece. It is convenient to blow the ball out of a stout piece of glass tubing, held in the plane of the plate. The ball then leaves its trace upon the plate, as this figure shows; and the form of orbit is purely a question of initial velocity. Lowest speed gives a close approach to the ellipse with the pole-piece at one of its foci; friction of the ball in the lampblack will reduce the velocity so that the ball is likely to be drawn in upon the center of attraction, on completing one revolution. A higher speed gives the parabola, whose form is also somewhat modified by unavoidable lessening of the ball's velocity; and still higher initial velocities

produce the two hyperbolas, *C* and *D*. This ingenious experiment is due to Wood. The true form of all these curves is given on page 347.

Mutual Attractions.—One farther step had to be taken, to apply Newton's third law of motion to the case of sun, moon, and planets. This law states that whenever one body exerts a force upon another, the latter exerts an equal force in the opposite direction upon the first. Earth, then, cannot attract moon without moon's also attracting earth with an equal force oppositely directed. Sun cannot attract earth unless earth also attracts sun in a similar manner. So, too, the planets must attract each other; and if they do, their motions round the sun must be mutually disturbed, in accor-

dance with the second law of motion. Kepler's laws, then, must need some slight change to fit them to the actual case of mutual attractions. But it was known from observation that the planets deviate slightly from Kepler's laws in going round the sun. The question, then, arose whether deviations really observed are precisely matched by calculated attractions of planets upon each other. Newton could not answer this question completely, because the mathematics of his day was insufficiently developed; but over and over again, refined observations of moon and planets since his time have been compared with theories of their movements founded on Newton's law of universal gravitation, as interpreted by the higher mathematics of a later day, until the establishment of that law has become complete and final. Essentially everything is accounted for. And unexpected and triumphant verification came with the discovery of Neptune in 1846; for this proved that the law of mutual attractions was capable, not only of explaining the motions of known bodies, but of pointing out an unknown planet by disturbance it produced in the motion of a known and neighboring one.

Earth and Moon revolve round their Common Center of Gravity.—It has been said that the moon revolves round the earth. This statement needs modification, and it admits of ready illustration. Strictly speaking, the moon revolves, not round the earth, but round the center of gravity of earth and moon considered as a system or unit. And as moon's attraction for earth is equal to earth's for moon, the center of our globe must revolve round that center of gravity also.

Cut a cardboard figure like that on the current page—exact size inessential. Its center of gravity will lie somewhere on the line joining the centers of the two disks, and is easily found by trial, puncturing the card with a pin until point is found where disks balance each other, and gravity has no tendency to make the card swing round. This point will be the center of gravity. Around it describe a circle passing through center of large disk; and from the same center describe also an arc passing through cen-



Motion of Earth's Center of Gravity

ter of smaller disk. Twirl the card round its center of gravity, by means of a pencil or penholder; or the card may be projected into the air, spinning horizontally, and allowed to fall to the floor: these circular arcs, then, represent paths in space actually traversed by centers of earth and moon. To find where center of gravity of earth-moon system lies in the real earth, recall that the mass of our globe is 81 times that of the moon. Moon's center is therefore 81 times as far from center of gravity of the system as earth's center is. This places the common center at a continually shifting point always within the earth, and at an average distance of 1000 miles below that place on its surface where the moon is in the zenith. That the earth really does swing round in this monthly orbit nearly 6000 miles in diameter is a fact readily and abundantly verified by observation.

The Newtonian Law of Universal Gravitation.—If this attraction for common things, possessed by the earth and called gravity, extends to the moon; if the same force, only greater on account of greater mass of central body, controls the satellites of Jupiter in their orbits; if the same attraction, greater still on account of the yet greater mass of the sun, holds all the planets in their paths around him, may it not extend even to the stars? But these bodies are so remote that excessive diminution of the sun's gravitation, in accordance with the law of inverse squares, would render that force so weak as to be unable to effect any visible change in their motion, even in thousands of years. As observed with the telescope, motions of certain massive stars relatively near each other do, however, uphold the Newtonian law. No reason, therefore, exists for doubting its sway throughout the whole universe of stars. If we pass from the infinitely great to the infinitely little, dividing and subdividing matter, as far as possible, each particle still has weight, and therefore must possess power of attraction. Gravity, then, attracts each particle to the earth, and in accordance with the third law of motion, each particle must attract the earth in turn and equally. So the gravitation of earth and moon, for example, is really the mutual attraction of all the particles composing both these bodies. In its universality, then, this simple but all-comprehensive law may finally be written: *Every particle of matter in the universe attracts every other particle with a force exactly proportioned to the product of the masses, and inversely as the square of the distance between them.*

Curvilinear Motion: No Propelling Force needed.—Newton's theory amounts simply to this: Granted that planets and satellites were in the beginning set in motion (it does not now concern us in what manner), then the attraction of gravitation—of the sun for all the planets and of each planet for its satellites—completely accounts for the curved forms of their orbits, and for all their motions therein. It may be supposed that the

state of motion was originally impressed upon these bodies by a projectile force, or that their present motions are a resultant inheritance from untold ages of development of the solar system from the original solar nebula, in accordance with the working of natural laws. Once set in motion, however, Newton's theory suffices to show that there is no propelling or other force always pushing from behind, nor is the action of any such force at all necessary to keep them going. Once started with a certain velocity, the uninterrupted working of gravitation maintains every body continually in motion round its central orb. In one part of its elliptic path, a planet, for example, may recede from the sun, but the sun again pulls it back; afterward it again recedes, but equally again it returns, perihelion and aphelion perpetually succeeding each other. Gravitation alone explains perfectly and completely all motions known and observed.

Why the Earth does not fall into the Sun.—Draw several arrows tangent to the ellipse at different points, to show in each case the direction in which earth is going when at that point.

From these points of tangency draw dotted lines toward that focus where the sun is, to represent direction in which gravitation is acting. It is apparent that the planet is never moving directly toward the sun, but always at a very large angle with the radius vector; greatest at perihelion, *B*, and aphelion, *D*, where it becomes a right angle. There the sun is powerless either to accelerate or retard. According to Kepler's second law, velocity in orbit is continually

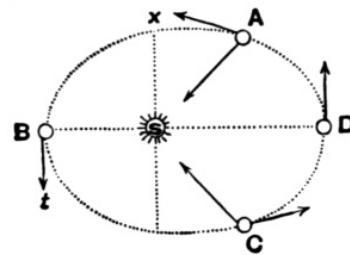

Earth is never moving directly towards the Sun

increasing from aphelion to perihelion, because gravitation is acting at an acute angle with the direction of motion *A*. Therefore earth's motion is all the time accelerated, until it reaches perihelion. Here velocity is a maximum, because the sun's attraction has evidently been helping it along, ever since leaving aphelion. Gravitation of the sun, too, has increased, exactly as the square of the planet's distance has decreased. Calculating these two forces at perihelion, it is found that earth's velocity makes the tendency to recede even stronger than the increased attraction of the sun; so that our planet is bound to pass quickly by its nearest point to the sun, and recede again to aphelion. On reaching its farthest point, relation of the two forces is reversed; velocity has been diminishing all the way from perihelion, because gravitation is acting at an obtuse angle with direction of motion, *C*. The earth is all the time retarded, gravitation holding it back, until at aphelion its velocity is so much lessened that even the enfeebled attraction

of the sun overpowers it, and therefore begins to draw the earth toward perihelion again. So all the planets are perpetually preserved (1) against falling into the sun, and (2) against receding forever beyond the sphere of his attraction. At points where both these catastrophes at first seem most likely to occur, direction of planet's motion is always exactly at right angles to the attracting force; thus is assured that curvature of orbit requisite to carry it farther away from the sun in the one case, and in the other to bring it back nearer to him.

Strength of the Sun's Attraction.—It was shown, on page 125 that the earth, in traveling $18\frac{1}{2}$ miles, is bent from a truly straight course only one ninth of an inch by the sun's attraction. So it might seem that the force is not very intense after all. But by calculating it and converting it into an equivalent strain on ordinary steel, it has been found that a rod or cylinder of this material 3000 miles in diameter would be required to hold sun and earth together, if gravitation were to be annihilated. Or, if instead of a solid rod, the force of attraction were to be replaced by heavy telegraph wires, the entire hemisphere of the earth turned toward the sun would need to be thickly covered with them,—about 10 to every square inch of surface. But the necessity for this vast quantity of so strong a material as steel becomes apparent on recalling that the weight of the earth is six sextillions of tons, while the weight of the sun is more than 330,000 times greater; and the stress between them is equal to the attraction of sun and earth for each other. Gravitation in the solar system must be thought of as producing stresses of this character between all bodies composing it, and taken in pairs; stress between each pair being proportional to the product of their masses, and varying inversely as the square of the distance separating them varies. Sun disturbs the moon's elliptic motion greatly, and even Venus, Mars, and Jupiter perturb it perceptibly.

What is Gravitation?—Distinction is necessary between the terms *gravity* and *gravitation*. On page 77 it was shown that gravity diminishes from pole to equator, on account of (1) centrifugal force of earth's rotation, and (2) oblateness of earth, or its polar flattening, by which all points on the equator are further from the center than the poles are. Earth's attraction lessened in this manner is called gravity. Gravitation, on the other hand, is the term used to denote cosmic attraction in accordance with the Newtonian law, between all bodies of the universe taken in pairs, and depending solely upon the product of the masses of each pair and the distance which separates them. Do not make the mistake of saying that Newton discovered gravity, or even gravitation; for that would be much like saying that Benjamin Franklin discovered lightning. Men had always seen and known that everything is held down by a force of some sort, and had recognized from the earliest

times that bodies possess the property called weight. What Newton did do, however, was to discover the universality of gravitation, and the law of its action between all bodies: upon all common objects at the surface of the earth; upon the moon revolving round us; and upon the planets and comets revolving round the sun. This cardinal discovery is the greatest in the history of astronomy. Great as it is, however, it is not final; for Newton did not discover, nor did he busy himself inquiring, *what* gravitation is. Indeed, that is not yet known. We only know that it acts instantaneously over distances whether great or small, and in accordance with the Newtonian law; and no known substance interposed between two bodies has power to interrupt their gravitational tendency toward each other. How it can act at a distance, without contact or connection, is a mystery not yet fathomed.

Weighing a Planet that has a Satellite.—If a planet has a satellite, it is easy to find the mass, or quantity of matter in terms of sun's mass. First observe mean distance of satellite from its primary, and then find the time of revolution. Cube the distance of any planet from the sun, and divide by square of periodic time; the quotient will be the same for every planet, according to Kepler's third law. Also cube the distance of any satellite of Saturn from the center of the planet, and divide by the square of its time of revolution: the quotient will be the same for every satellite, if distances and periodic times have been correctly measured. Do the same for satellites of other planets,—Mars, Jupiter, Uranus, and Neptune. The quotients will be proportional in each case to mass of central body in terms of the sun; in the case of Saturn, for example, the quotient for each satellite will be $\frac{1}{3501}$ that for sun and planets. The sun, then, is 3501 times more massive than Saturn, as found by A. Hall, Jr. Similarly may be found the mass of any other planet attended by a satellite. It is not necessary to know the mass of the satellite, because the principle involved is simply that of a falling body; and we know, in the case of the earth, that a body weighing 100 pounds or 1000 pounds will fall no swifter than one which weighs only 10 pounds. By the same method, too, binary stars are weighed (page 395), when their distances from each other and times of revolution become known.

Weighing a Planet that has No Satellite.—This is a much more difficult problem; fortunately only two large planets without satellites are known,—Mercury and Venus. Their masses can be ascertained only by finding what disturbances they produce in the motions of other bodies near them. The mass of Venus, for example, is found by the deviation she causes in the motion of the earth. The mass of Mercury is found by the perturbing effect upon Encke's comet, which often approaches very near him. The Newtonian law of gravitation forms the basis of the intricate calculations by which the mass is found in such a case. But the result is reached only

by a process of tedious computation and is never certain to be accurate. Much more precise and direct is the method of determining a planet's mass by its satellite.

The vast difference between the two methods was illustrated at the Naval Observatory, Washington, 1877, shortly after the satellites of Mars were discovered. The mass of that planet, as previously estimated from his perturbation of the earth, was far from right, although it had cost months of figuring, based upon years of observation. Nine days after the satellites were first seen, a mass of Mars very near the truth was found by only a half hour's facile computation.

Weighing the Sun.—In weighing the planets, the sun is the unit. Our next inquiry is, what is the sun's own weight? How many times does the mass of the sun exceed that of the earth? Evidently the law of gravitation

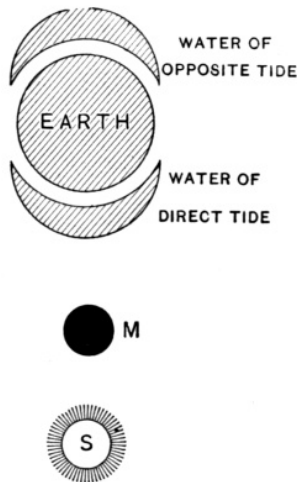

To explain the Direct and the Opposite Tides

will afford an answer to this question if we compare the attraction of sun with that of earth at equal distances. At the surface of the earth a body falls 16.1 feet in the first second of time. Imagine the sun's mass all concentrated into a globe the size of the earth: how far would a body on its surface fall in the first second? First recall how far the earth falls toward the sun (or deviates from a straight line) in a second: it was found to be 0.0099 feet (page 125). This is deflection produced by the sun at a distance of 93,000,000 miles. But we desire to know how far the earth would fall in a second, were its distance only 4000 miles from the sun's center; that is, if it were 23,250 times nearer. Obviously, as attraction varies inversely as the square of the distance, it would fall $0.0099 \times [23.250]^2$, or 5,351,570 feet.

But we saw that the earth's mass causes a body to fall 16.1 feet in the first second; therefore the sun's mass is nearly 332,000 times greater than that of the earth.

Gravitation explains the Tides.—According to the law of gravitation, the attraction of moon and earth is mutual; moon attracts earth as well as earth attracts moon. Earth, then, may be considered also as traveling round the moon (page 334). Therefore, earth falls toward moon, just as moon in going round earth is continually dropping from the straight line in which it would move, if gravitation were not acting. Imagine the earth made up of three parts (on this page), independent and free to move upon each other: (a) the waters on the side toward the moon; (b) the solid earth

itself; (c) the waters on the side away from the moon. In going round moon or sun, these three separate bodies would fall toward it, through a greater or less space according to their individual distance from sun or moon. Waters of the opposite tide, therefore, would fall moonward or sunward through the least distance, waters of the direct tide through the greatest distance, and the earth itself through an intermediate distance. The resultant effect would be a separation from earth of the waters on both near and further sides of it. As, however, the real earth and the waters upon it are not entirely independent, but only partially free to move relatively to each other, the separation actually produced takes the form of a tidal bulge on two opposite sides. These are known as the direct and the opposite tides.

Tides raised by the Sun.—Besides our satellite the only other body concerned in raising tides in the waters of the earth is the sun. Newton demonstrated that the force which raises tides is proportional to the difference of attractions of the tide-raising body on two opposite sides of the earth. Also he showed that this force becomes less as the cube of the distance of tide-producing body grows greater. It is, therefore, only a small portion of the whole attraction, and the sun tide is much exceeded by that of the moon. To ascertain how much: first as to masses merely, supposing their distances equal, sun's action would be $26\frac{1}{2}$ million times that of moon,

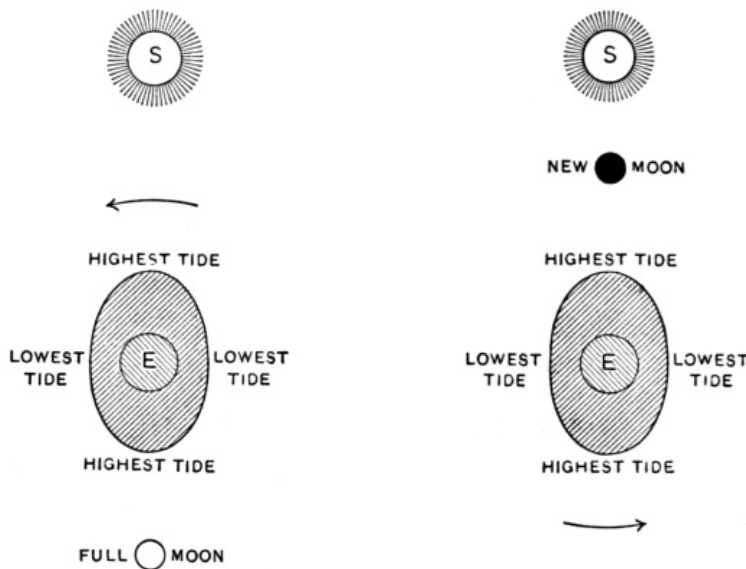

Spring Tide at Full Moon

Spring Tide at New Moon

because his mass is $81 \times 332,000$ times greater. But sun's distance is also

390 times greater than the moon's; so that

$$\frac{26\frac{1}{2} \text{ millions}}{(390)^3}$$

expresses the ratio of sun tide to moon tide, or about the relation of 2 to 5.

Sun Tides and Moon Tides combined.—As each body produces both a direct and an opposite tide, it is clear that very high tides must be raised at new moon and at full moon, because sun and moon and earth are then in line. These are spring tides (or high-rising tides), occurring, as the figures on the previous page show, twice every lunation. Similarly is explained the formation of lesser tides, called neap tides, which occur at the moon's first and third quarters. Instead of conspiring together to raise tides, the attraction of the sun acts athwart the moon's, so that the resultant neap tides are raised by the difference of their attractions, instead of the sum. Both relations of sun, moon, and earth producing such tides

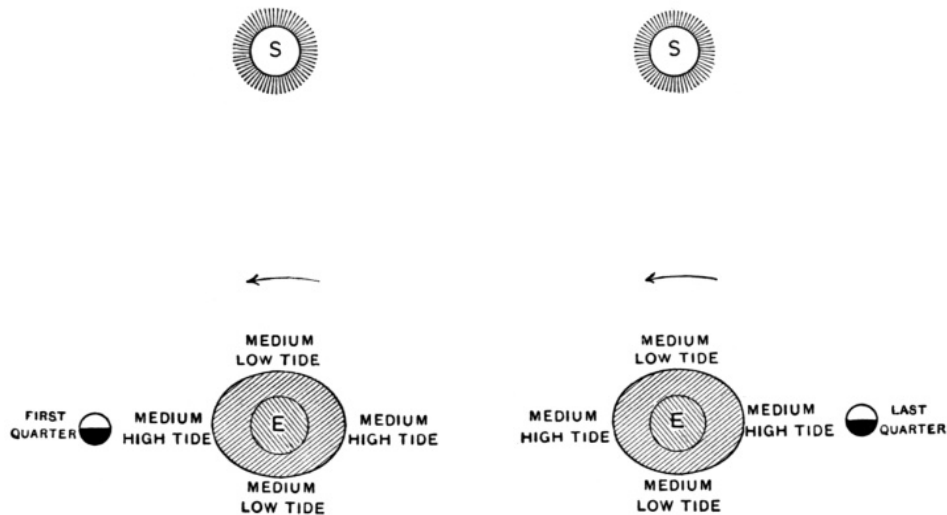

Neap Tide at First Quarter

Neap Tide at Last Quarter

are shown. Considering only average distances of sun and moon, spring tides are to neap tides about as 7 to 3. For the earth generally, highest and lowest spring tides must occur when both sun and moon are nearest the earth; that is, when the moon at new or full comes also to perigee, about the beginning of the calendar year. The complete theory of tides can be explained only by application of the higher mathematics. But the law of gravitation, taken in connection with other physical laws, fully accounts for all observed facts; so that the tides form another link in the chain of argument for universal gravitation.

The Cause of Precession.—Precession and its effect upon the apparent positions of the stars have already been described and illustrated in Chapter VI. This peculiar behavior of the earth's equator is due to the gravitation of sun and moon upon the bulging equatorial belt or zone of the earth, combined with the centrifugal force at the earth's equator. As equator stands at an inclination to ecliptic, this attraction tends, on the whole, to pull its protuberant ring toward the plane of the ecliptic itself. But the earth's turning on its axis prevents this, and the resultant effect is a very slow motion of precession at right angles to the direction of the attracting force, similar to that exemplified by attaching a small weight to the exterior ring of a gyroscope. Three causes contribute to produce precession: if the earth were a perfect sphere, or if its equator were in the same plane with its path round the sun (and with the lunar orbit), or if the earth had no rotation on its axis, there would be no precession. The action of forces producing precession is precisely similar to that which raises the tidal wave; and, accordingly, solar precession takes place about two fifths as rapidly as that produced by the moon. The slight attraction of the planets gives rise to a precession $\frac{1}{450}$ that of sun and moon.

Nutation of the Earth's Axis.—Nutation is a small and periodic swinging or vibration of the earth's poles north and south, thereby changing declinations of stars by a few seconds of arc. The axis of our globe, while traveling round the pole of the ecliptic, A , has a slight oscillating motion across the circumference of the circle described by precession. So that the true motion of the pole does not take place along pp' , an exact small circle around A as a pole, but along a wavy arc as shown in next illustration. The earth's pole is at P only at a given

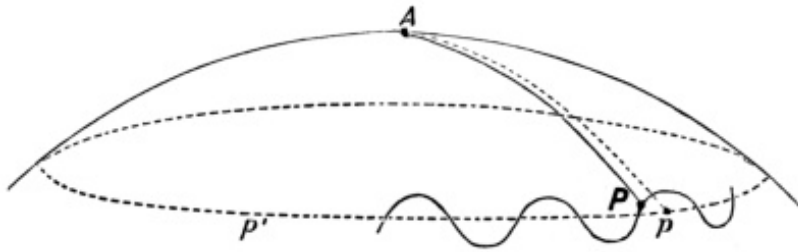

Illustrating Motion of the Celestial Pole by Nutation

time. This *nodding* motion of the axis, and consequent undulation in the circular curve of precession, is called nutation. The period of one cross oscillation due to lunar nutation is $18\frac{3}{5}$ years, so that the number of waves around the entire circle is greatly in excess of the proportion represented in the figure. In reality there are nearly 1400 of them. Just as the celestial equator glides once round on the

ecliptic in 25,900 years, as a result of precession, so the moon's orbit also slips once round the ecliptic in $18\frac{3}{5}$ years, thereby changing slightly the direction of moon's attraction upon the equatorial protuberance of our earth, and producing nutation.

When Newton had succeeded in proving that his law of universal gravitation accounted not only for the motions of the satellites round the planets, for their own motions round the sun, for the rise and fall of the tides, and for those changes in apparent positions of the stars occasioned by precession and nutation, evidence in favor of his theory of gravitation became overwhelming, and it was thenceforward accepted as the true explanation of all celestial motions.

Chapter XV

Comets and Meteors

Comets, as well as other unusual appearances in the heavens, were construed by very ancient peoples into an expression of disapproval from their deities. 'Fireballs flung by an angry God,' they were for centuries thought to be 'signs and wonders,—a sort of celestial portent of every kind of disaster. The downfall of Nero was supposed to be heralded by a comet; and for centuries the densest superstition clustered about these objects.

True Theory of Comets not Modern.—Chaldean stargazers were apparently the sole ancient nation to regard comets as merely harmless wanderers in space. The Pythagoreans only, of the old philosophers, had some general idea that they might be bodies obeying fixed laws, returning perhaps at definite intervals.

Seneca held this view, and Emperor Vespasian attempted to laugh down the popular superstitions. But in those days, far-seeing utterances had little effect upon a world full of obstinate ignorance. Some of the old preachers proclaimed that comets are composed of the sins of mortals, which, ascending to the sky, and so coming to the notice of God, are set on fire by His wrath. Texts of Scripture were twisted into apparent proofs of the supernatural character of comets, and for seventeen centuries beliefs were held that fostered the worst forms of fanaticism. Copernicus, of course, refused to regard comets as supernatural warnings, but the 16th century generally accepted their evil omen as a matter of course. By the middle of the 17th century came the dawn of changing views, although even as late as the end of that century, knowledge of the few facts known about comets was kept so far as possible from students in the universities, that their religious beliefs might not be contaminated.

But credence began to be given to the statements of Tycho Brahe and Kepler that comets were supralunar, or beyond the moon, and perhaps not so intimately concerned in 'war, pestilence, and famine' as had been believed. Newton farther demonstrated that comets are as obedient to law

as planets; and with his authoritative statements came the full daylight of the modern view.

Discoveries of Comets.—Comets are nearly all discovered by apparent motion among the stars. The illustration shows the field of view of a telescope, in which appeared each night two faint objects. Upper one remained stationary among the stars, but lower one was recognized as a comet because it moved, as the arrow shows, and was seen each night farther to the right. A century ago, Caroline Herschel in England, and Messier in France, were the chief discoverers of comets. Pons discovered 30 comets in the first quarter of the 19th century.

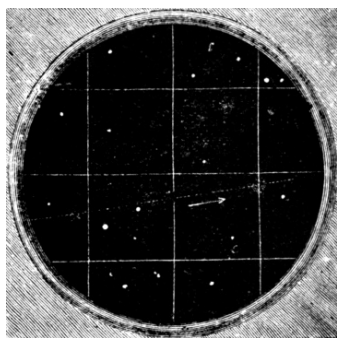

A Comet is discovered by its Motion

Among other noteworthy European ‘comet-hunters’ during the middle and latter half of this century were Brorsen, Donati, and Tempel. In America, Swift, Brooks, and Barnard have been preëminently successful. Between them and several other astronomers, both at home and abroad, the entire available night-time sky is parceled out for careful telescopic search, and it is not likely that many comets, at all within the range of visibility from the earth, escape their critical gaze. Sweeping for comets is an attractive occupation, but one requiring close application and much patience. Large and costly instruments are by no means necessary. Messier discovered all his comets with a spyglass of $2\frac{1}{2}$ inches diameter, magnifying only five times; and the name of Pons, the most successful of all comet-hunters, a doorkeeper at the observatory of Marseilles, is now more famous in astronomy than that of Thulis, the then director of that observatory, who taught and encouraged him.



Early View of Donati's Comet (1858)

Their Appearance.—Usually a comet has three parts. The *nucleus* is the bright, star-like point which is the kernel, the true, potential comet. Around this is spread the *coma*, a sort of luminous fog, shading from the nucleus, and forming with it the *head*. Still beyond is the delicate

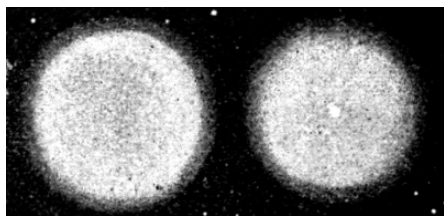

Telescopic comet without and with nucleus



Halley's Comet (1835)

tail, stretching away into space. And this to the world in general is the comet itself, though always the least dense of the whole. Sometimes entirely wanting, or hardly detectible, the tail is again an extension millions of miles long. Although usually a single brush of light, comets have been seen with no less than six tails.

Changes in Appearance.—With increase in a comet's speed on approaching the sun and its state of excitation, part tidal and part perhaps electrical, its appearance changes accordingly. When remote from the sun, comets are never visible except by aid of a telescope, and their appearance is well shown on this page; but on approaching nearer the sun, a nucleus will often develop and throw off jets of luminosity toward the sun, sometimes curving round and opening like a fan. On rare occasions the comet will become so brilliant as to be visible in broad daylight. After growth of the *coma* comes development of the tail; and this showy appendage sometimes reaches stupendous lengths, even so great as sixty millions of miles, growing often several million miles in a day.



Head of Donati's Comet (1858)

Development and Direction of Tail.—It is not a correct analogy that the tail streams out behind like a shower of sparks from a rocket. There is no medium to spread the tail; for there is no material substance

like air in interplanetary space, and therefore nothing to sweep the tail into the line of motion. Explanation of the backward sweep of the tail, nearly always away from the sun, as in above diagram, is found in the fact that while the comet is attracted, the tail is strongly repelled by the sun. Rapid growth of tail upon approaching the sun is explainable in this way: the comet as a solid is attracted; but when it comes near enough to be partly dissipated into vapor, the highly rarefied gas is so repelled that gravitation is entirely overcome, and the tail streams visibly away from the sun. Probably electrical repulsion and perhaps also the direct pressure of sunlight are concerned. As the comet recedes, the great heat diminishes; and the tail becomes smaller, because less material is converted into vapor.

Types of Cometary Tails.—

Bredichin divides tails of comets into three types: (1) those absolutely straight in space, or nearly so, like the tail of the great comet of 1843; (2) tails gently curved, like the broad streamer of Donati's comet of 1858 (page 18); (3) short bushy tails, curving sharply round from the comet's nucleus, as in Encke's comet. The origin of tails of the first type is related to ejections of hydrogen, the lightest element known, and the sun's repulsive force is in this case 14 times stronger than his gravitative attraction. The slightly curved tails of the second type are due to hydrocarbons repelled with a force somewhat in excess of solar gravity. In producing the sharply curved tails of the third type, the sun's repellent energy is about one fifth that of his gravity, and these tails are formed from emanations of still heavier substances, principally iron and chlorine.

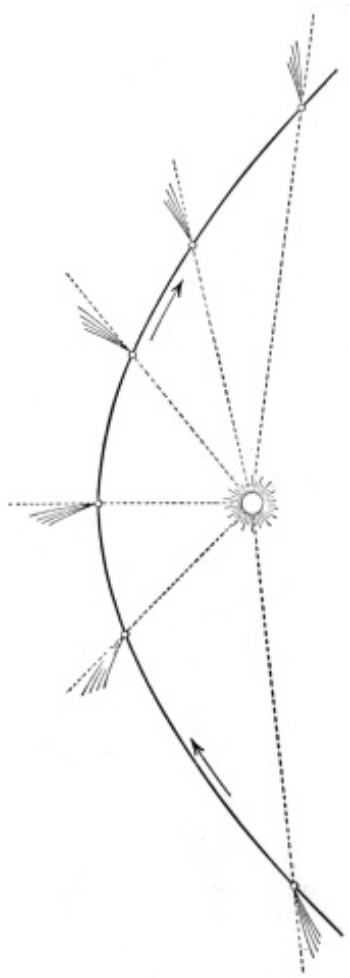

Tail always point away from the Sun

This theory permits a complete explanation of a comet's possessing tails of two different types; or even tails of all three distinct types. An excellent photograph of comet Rordame-Quénisset (1893) showed four tails, which subsequently condensed into a single one. Evidently the ejections may be at differ-

ent times connected with hydrogen, hydrocarbon, or iron, or any combination of these, according to the chemical composition of substances forming the nucleus.

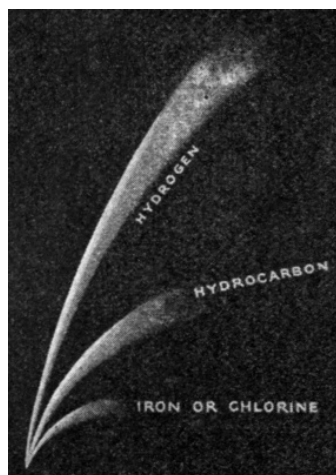

Types of Cometary Tails (Bredichin)

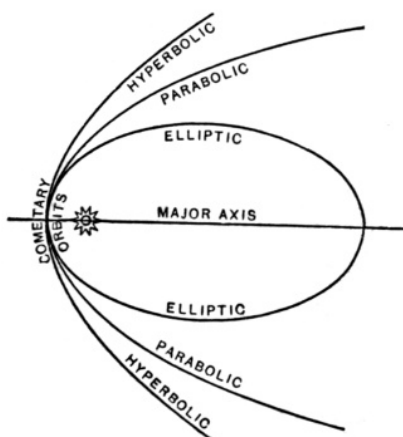

Form of Cometary orbits

Observations for an Orbit.—As soon as a new comet is discovered, its position among the stars is accurately observed at once. On subsequent evenings, these observations are repeated; and after three complete observations have been obtained, the precise path of the comet can generally be calculated. This path will be one of the three conic sections: (1) if it is an ellipse, the comet belongs to the class of periodic comets, and the length of its period will be greater as the eccentricity of orbit is greater; (2) if the path is a parabola, the comet will retreat from the sun along a line nearly parallel to that by which it came in from the stellar depths; (3) if a hyperbola, the paths of approach to and recession from the sun will be widely divergent.

Cometary Orbits.—Some comets are permanent members of the solar system, while others visit us but once. Three forms of path are possible to them,—the *ellipse*, the *parabola*, and the *hyperbola*. With a path of the first type only can the comet remain permanently attached to the sun's family. The other two are open curves, as in above diagram; and after once swinging closely round the sun, and saluting the ruler of our solar system, the comet then plunges again into unmeasured distances of space.

Whether or not an orbit is a closed or open curve depends entirely upon velocity. If, when the comet is at distance unity, or 93,000,000 miles from the sun, its speed exceeds 26 miles a second, it will never come back; if less, it will

return periodically, after wanderings more or less remote. Very often the velocity of a comet is so near this critical value, 26 miles a second, that it is difficult to say certainly whether it will ever return or not. Many comets, however, do make

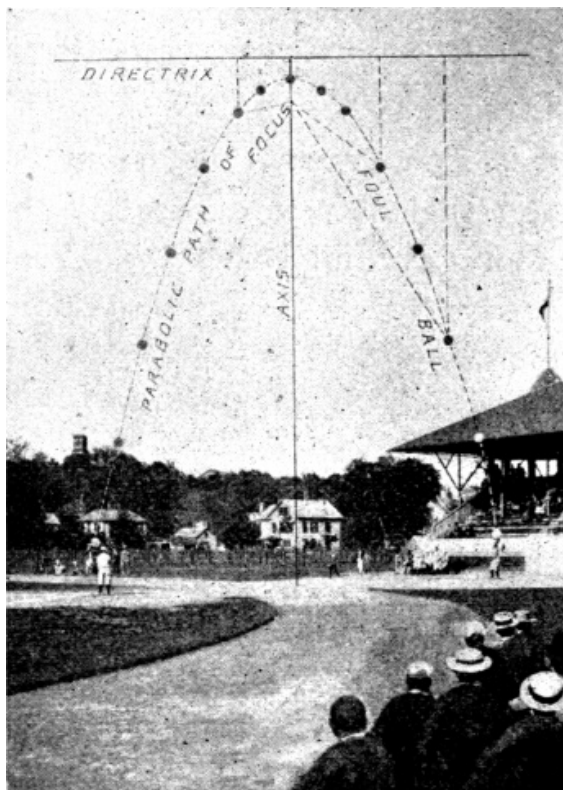

A Projectile's Path is a Parabola

(From an Instantaneous Photograph by Lovell)

periodical visits which are accurately foretold. The form, and position of their orbits show in numerous instances that these comets were captured by planetary attraction, which has reduced their original velocity below 26 miles a second, and thus caused them to remain as members of the solar system indefinitely, and obedient to the sun's control.

A Projectile's Path is a Parabola.—This proposition, demonstrated mathematically from the laws of motion, is excellently verified by observation of the exact form of curves described by objects thrown high into the air. Resistance of the atmosphere does not affect the figure of the curve appreciably, unless the velocity is very swift. A 'foul ball' frequently exhibits the truth of this proposition beautifully, in its flight from the bat, high into the air, and then swiftly down to the 'catcher,' whom the photograph shows in the act of catching the ball, though somewhat exaggerated in size. The horizontal line above the parabola is called the *directrix*, and the vertical line through the middle of the parabola is its *axis*. One point in the axis, called the *focus*, is as far below the vertex as the directrix is above it. This curve has a number of remarkable properties, one of which is that every point in the curve is just as far from the focus as it is perpendicularly distant from the directrix (shown by equality of the dotted lines). Another property, very important and much utilized in optics, is this: from a tangent at the point of the parabola, the line from this point to the focus makes the same angle with the tangent that a line drawn from the point of tangency parallel to the axis does. According to this property, parallel rays all converge to the focus

periodical visits which are accurately foretold. The form, and position of their orbits show in numerous instances that these comets were captured by planetary attraction, which has reduced their original velocity below 26 miles a second, and thus caused them to remain as members of the solar system indefinitely, and obedient to the sun's control.

A Projectile's Path is a Parabola.—This proposition, demonstrated mathematically from the laws of motion, is excellently verified by observation of the exact form of curves described by objects thrown high into the air. Resistance of the atmosphere does not affect the figure of the curve appreciably, unless the velocity is very swift. A 'foul ball' frequently exhibits the truth of this proposition

of a reflector (page 172).

Direction of their Motion.—Unlike members of the solar system in good and regular planetary standing, comets move round the sun, some in the same direction as the planets; others revolve just opposite, that is, from east to west. The planes of cometary orbits, too, lie in all directions—their paths may be inclined as much as 90° to the ecliptic. A comet can be observed from the earth, and its position determined, only while in that part of its orbit nearer the sun. Generally this is only a brief interval relatively to the comet's entire period, because motion near perihelion is very swift. It is doubtful whether any comet has ever been observed farther from the sun than Jupiter.

Dimensions of Comets.—Nucleus and head or *coma* of a comet are the only portions to which dimension can strictly be assigned. There are doubtless many comets whose comæ are so small that we never see them—probably all less than 15,000 miles in diameter remain undiscovered. The heads of telescopic comets vary from about 25,000 to 100,000 miles in diameter; that of Donati's comet of 1858 was 250,000 miles in diameter, and that of the great comet of 1811, the greatest on record, was nearly five times as large. Tails of comets are inconceivably extensive, short ones being about 10,000,000 miles long, and the longest ones (that of the comet of 1882, for example) exceeding 100,000,000. To realize this prodigious bulk, one must remember that if such a comet's head were at the sun, the tail would stretch far outside and beyond the earth.

The Periodic Comets.—Comets moving round the sun in well-known elliptic paths are called periodic comets. About 30 such are now known, with periods less than 100 years in duration, the shortest being that of Encke's comet ($3\frac{1}{3}$ years), and the longest that of Halley's (about 76 years). Nearly all of these bodies are invisible to the naked eye, and only about half of them have as yet been observed at more than a single return. Nearly as many more comets travel in long oval paths, but their periods are hundreds or even thousands of years long, so that their return to perihelion has not yet been verified.

Planetary Families of Comets.—When periodic comets are classified according to distance from the sun at their aphelion, it is found that there is a group of several corresponding to the distance of each large outer planet from the sun. Of these, the Jupiter family of comets is the most numerous, and the orbits of many of them are excellently shown on the next page. Without much doubt, these comets originally described open orbits, either parabolas or hyperbolas; but on approaching the sun, they passed so near Jupiter that he reduced their velocity below the parabolic limit,

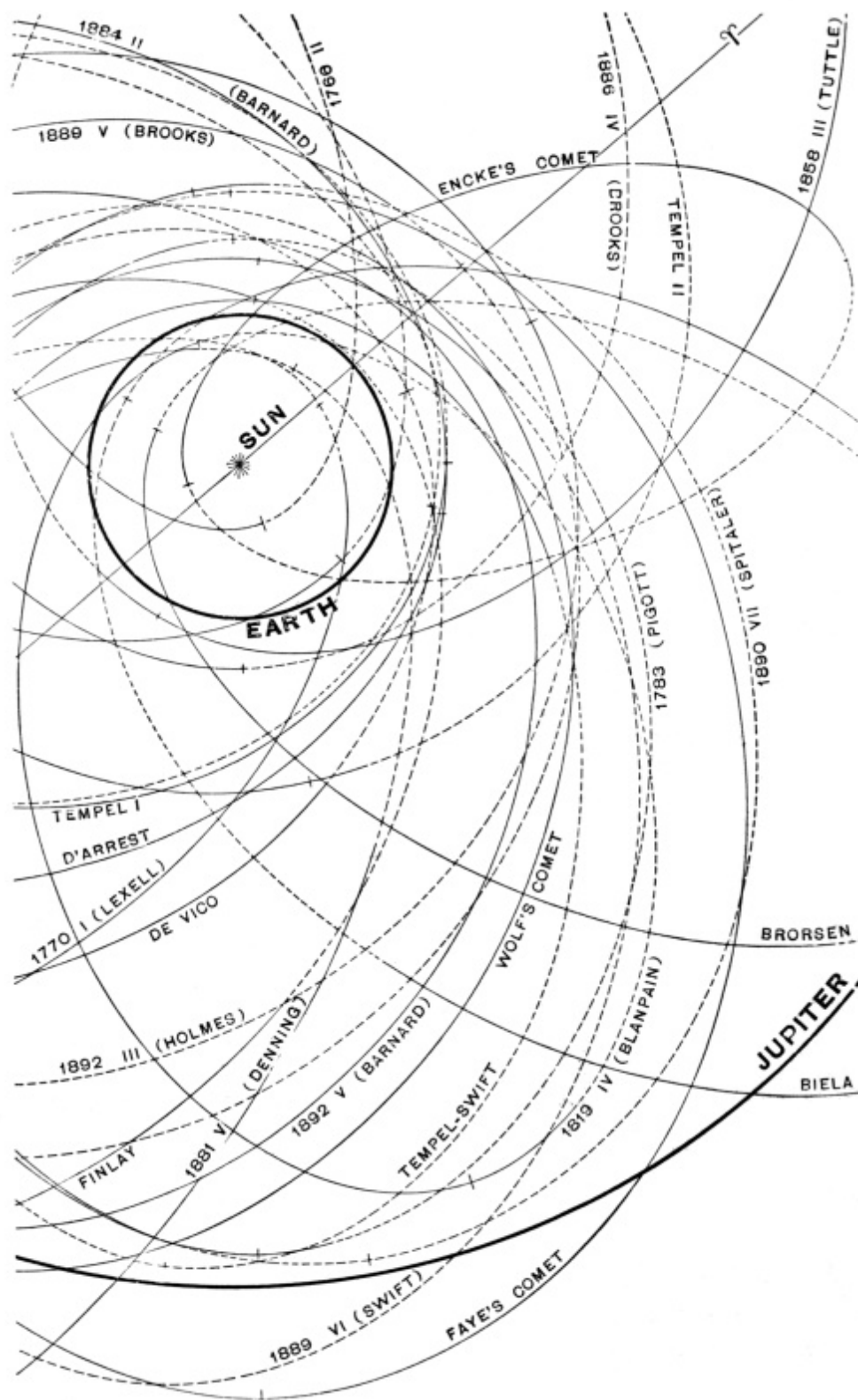

Jupiter's Family of Comets. (From Professor Payne's *Popular Astronomy*)

and they have since been forced to travel in elliptical orbits, having indeed been captured by the overmastering attraction of the giant planet. While Jupiter's family of comets numbers 18, Saturn similarly has 2, Uranus 3, and Neptune 6.

Groups of Comets.—Vagaries in structure of comets prevent their identification by any peculiarities of mere physical appearance. Identity of these bodies then, or the return of a given comet, can be established only by similarity of orbit. In several instances comets have made their appearance at irregular intervals, traveling in one and the same orbit. They could not be one and the same comet; so these bodies pursuing the same track in the celestial spaces are called groups of comets.

The most remarkable of these groups consists of the comets of 1668, 1843, 1880, 1882, and 1887, all of which travel tandem round the sun. Probably they are fragments of a comet, originally of prodigious size but disrupted by the sun at an early period in its history; because the perihelion point is less than 500,000 miles from the sun's surface. At this distance an incalculably great disturbing tidal force would be exerted by the sun upon a body having so minute a mass and so vast a volume; and separate or fragmentary comets would naturally result.

Number of Comets.—In the historical and scientific annals of the past, nearly 1000 comets are recorded. Of these about 100 were reappearances; so that the total number of distinct comets known and observed is between 800 and 900.

During the centuries of the Christian era preceding the eighteenth, the average number was about 30 each century; but nearly all these were bright comets, discovered and observed without telescopes. As telescopes came to be used more and more, 70 comets belong to the eighteenth century, and nearly 300 to the nineteenth. Of this last number, less than one tenth could have been discovered with the naked eye; so that the number of bright comets appears to vary but little from century to century. The number of telescopic comets found each year is on the increase, because more observers are engaged in the search than formerly, and their work is done in accordance with a carefully organized system. About seven comets are now observed each year. Fewer are found in summer, owing to the short nights. During the 2000 years—although but 'a minute in the probable duration of the solar system'—the comets coming within reach of the sun must be counted by thousands; for it is probable that about 1000 comets

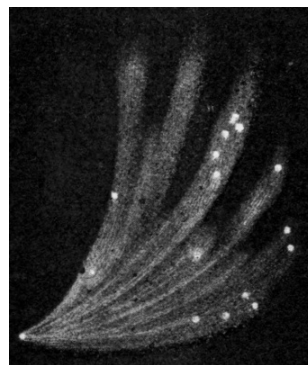

Cheseaux's Multi-tailed
Comet (1744)

pass within visible range from the earth every century. It is not, however, likely that more than half of these can ever be seen.

Remarkable Comets before 1850.—Comets of immense proportions have visited our skies since the earliest times. Others having singular characteristics must be mentioned also. Halley's comet is famous because it was the first whose periodicity was predicted. This was in 1704, but the verification did not take place till 1759, again in 1835, again in 1910, and it will reappear in 1986. The comet of 1744 (on the preceding page) had a fan-shaped, multiple tail. The great comet of 1811 was one of the finest of the 19th century, and its period is about 3000 years in duration. In 1818 Pons discovered a very small comet, which has become famous because of the short period of its revolution round the sun—only $3\frac{1}{3}$ years. This fact was discovered by Encke, a great German astronomer, and the comet is now known as Encke's comet. It has been seen at every return to perihelion, three times every ten years. Up to 1868, the period of Encke's comet was observed to be shortening, by about $2\frac{1}{2}$ hours, at each return; and this diminution led to the hypothesis of a resisting medium in space—not well sustained by more recent investigations. Encke's comet is inconspicuous, has

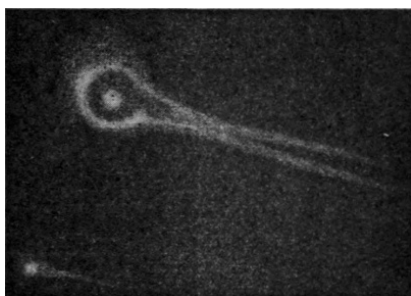

Biela's Double Comet (1845-46)

exhibited remarkable eccentricities of form and structure, and is now invisible without a telescope. Returns are in 1895, 1901, and 1911. The great comet of 1843, perhaps the most remarkable of all known comets, was visible in full daylight, and at perihelion the outer regions of its coma must have passed within 50,000 miles of the surface of the sun—nearer than any known body. At perihelion, its motion was unprecedented in swiftness, exceeding 1,000,000 miles an hour. Its period is between 500 and 600 years.

The Lost Biela's Comet.—Montaigne at Limoges, France, discovered in 1772 a comet which was seen again by Pons in 1805, and then escaped detection until 1826, when it was rediscovered and thought to be new by an Austrian officer named Biela, by whose name the comet has since been known. He calculated its orbit, and showed that the period was $6\frac{1}{2}$ years. At reappearance in 1845-46, it was seen to have split into two unequal fragments, as in the illustration, and their distance apart had greatly increased when next seen in 1852. At no return since that date has Biela's comet been seen; and the showers of meteors observed near the end of November in 1872, 1885, and 1892, are thought to be due to our earth passing near the orbit of this lost body, and to indicate its further, if not complete disintegration. These meteors are, therefore, known as the Bielids; also Andromedes, because they appear to come from the constellation of Andromeda. During the shower of 1885, on the 27th of November, a large iron meteorite fell,

and was picked up in Mazapil, Mexico. Without doubt it once formed part of Biela's comet.

Remarkable Comets between 1850 and 1875.—In 1858 appeared Donati's comet, which attained its greatest brilliancy in October, having a tail 40° long, sharply curved, and 8° in extreme breadth. Also there were two additional tails, nearly straight, and very long and narrow, as shown in the following illustration. Its orbit is elliptic, with a period of nearly 2000 years. In 1861 appeared another great comet. Its tail was fan-shaped, with six distinct emanations, all perfectly straight. The outer ones attained the enormous apparent length of nearly 120° , and were very divergent, owing to immersion of the earth in the material of the tail to a depth of 300,000 miles. This comet also travels round the sun in an elliptic path, with a period exceeding 400 years. The next fine comet appeared in 1874, and is known as Coggia's comet. Its nucleus was of the first magnitude, and its tail 50° in length, and very slightly curved. Coggia's comet was the first of striking brilliancy to which the spectroscope was applied, and it was found that its gaseous surroundings were in large part composed of hydrogen compounded with carbon. Coggia's comet, when far from perihelion, presented an anomalous appearance, well shown in the opposite illustration—a bright streak immediately following the nucleus and running through the middle of the tail. When nearer the sun, this streak was replaced by the usual dark one. No sufficient explanation of either has yet been proposed. The orbit of Coggia's comet is an ellipse of so great eccentricity that this body cannot reappear for thousands of years.



Donati's Triple-tailed Comet of 1858

Remarkable Comets between 1875 and 1890.—Only two require especial mention, the first of which was discovered in 1881, and was a splendid object in the northern heavens in June of that year. It was similar in type to Donati's comet of 1858, and was the first comet ever successfully photographed. In 1882 there were two bright comets, one of them in many respects extraordinary. So great was the intrinsic brightness that it was observed with the naked eye, close alongside the sun. Indeed, it passed between the earth and the sun, in actual transit; and just before entering upon the disk, the intrinsic brightness of the nucleus was seen to be scarcely inferior to that of the sun itself. It was a comet of huge proportions. Its tail stretched through space over a distance exceeding that of the sun from the earth, and parts of its head passed within 300,000 miles of the solar surface, at a speed of 200 miles a second. Probably this near approach

explains what was seen to take place on recession from the sun—the breaking up of the comet's head into several separate nuclear masses, each pursuing an independent path. Also this comet's tail presented a variety of unusual phenomena, at one time being single and nearly straight, while again there were two tails slightly curved. Besides this, its coma was surrounded by an enormous sheath or envelope several million miles long, extending toward the sun.

Remarkable Comets since 1890.—No very bright comet appeared between 1882 and 1901; but the Brooks comet of 1893, although a faint one and at

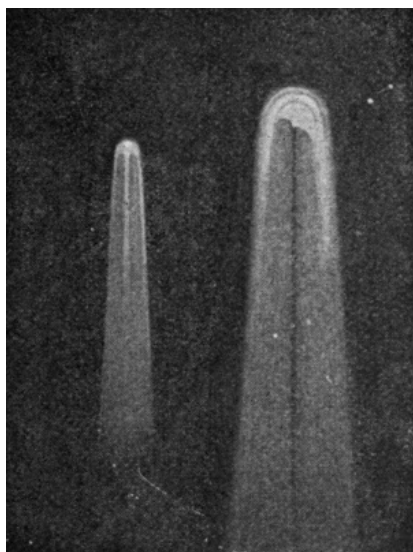

Drawings of Coggia's Comet
(1874)

no time visible to the naked eye, is worthy of note because of some remarkable photographs of it obtained by Barnard. The illustration (on the next page) is reproduced from one of them, and enlarged from the original negative. Changes in this comet were rapid and violent, and the tail appeared broken and distorted, like 'a torch flickering and streaming irregularly in the wind.' Ejections of matter from the comet's nucleus may have been irregular or it may have encountered some obstacle which shattered it—perhaps a swarm of meteors. A bright southern comet with a double tail 7° long was seen in 1901, and another in 1907. A brilliant comet with a tail 25° long appeared early in 1910, and Halley's returned the same year, though fainter than was expected (see page 366).

When will the Next Comet come?—If a large bright comet is meant, the answer must be that astronomers cannot tell. One may blaze into view at almost any time. During the latter half of the 19th century, bright comets came to perihelion at an average interval of about eight years. New though faint comets are discovered very frequently. Of the lesser and fainter periodic comets, several return nearly every year; but they are for the most part telescopic, and rarely attract the attention of any one save the astronomers.



Brooks's Comet of 1893 (photographed by Barnard)

Light of Comets.—The light of comets is dull and feeble, and not always uniform. When in the farther part of their orbits, comets seem to shine only by light reflected from the sun; and that is why they so soon become invisible, on going away from perihelion. They are then bodies essentially dark and opaque. But with approach toward the sun, the vast increase in brightness, often irregular, is due to light emitted by the comet itself, and it is this intrinsic brightness of comets, that, for the most part, makes them the striking objects they are. In some manner not completely understood, radiations of the sun act upon loosely compacted materials of the comet's head, producing a luminous condition which, in connection with the repulsive force exerted by that central orb gives rise to all the curious phenomena of the heads and tails of comets.

Chemical Composition.—Through analysis of the light of comets by the spectroscope, it is known that the chief element in their composition is carbon, combined with hydrogen; that is, hydrocarbons. The elements so far found are few. Sodium, magnesium, and iron were found in the great comet of 1882; also nitrogen, and probably oxygen. It is not certain that the spectrum of a comet remains always the same; perhaps there are rapid changes on approaching the sun. The faint continuous spectrum, a background for brighter lines in the blue, green, and yellow, is reflected sunlight.

The illustration shows a part of the spectrum of the comet of 1882, with the Fraunhofer lines *G*, *h*, *H*, *K*, and others, whose presence distinctly confirms this hypothesis. The spectra of between 20 and 30 comets have been observed in all, and they appear to have in general very nearly the same chemical composition.

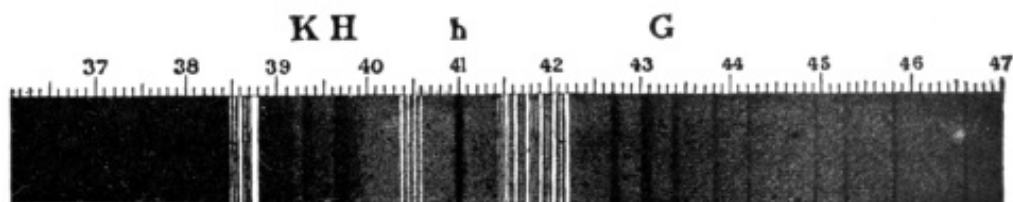

Spectrum of Comet of 1882 (Sir William Huggins)

Photographing Comets.—The light of a comet is usually feeble, at least so far as the eye is concerned, and its actinic power is even less. How then can a comet be photographed? Evidently in one of two ways only. Either the photographic plate must be very sensitive, or the exposure must be very long. Before invention of the modern sensitive dry plate, it had been found impossible to photograph comets. The first photograph of a comet was made by Henry Draper,

who photographed the comet of 1881. Since 1890 many faint comets have been successfully photographed at the Lick Observatory, and elsewhere, by the use of very sensitive plates and a long exposure. Figure 15.17 shows a photograph of Gale's comet (1894), in which the exposure was prolonged to 1 h. 0 m. The comet was moving rapidly, and as the clockwork moving the telescope was made to follow the comet accurately, all stars adjacent to it appear upon the photograph, not as points of light, but as parallel trails of equal length. Henry and Wilson have met with equal success.

Comets discovered during Eclipses.—Probably more than one half of all comets coming within range of visibility from earth remain undiscovered, because of the overpowering brilliancy of the sun. Ought not, then, new comets to be discovered during total eclipses of the sun? This has actually happened on at least two such occasions, and a like appearance has been suspected on two more.

During the total eclipse of the 17th of May, 1882, observed in Egypt, Schuster photographed a new comet alongside the solar corona, as shown on page 267. This comet was named for Tewfik, who was then khedive. Also another comet was similarly photographed, but joining immediately upon the streamers of the corona, during the total eclipse of the 16th of April, 1893, by Schaeberle in Chile. Both of these comets were new discoveries, and neither of them has since been seen. As there is but one observation of each, nothing is known about their orbits round the sun, nor whether they will ever return.

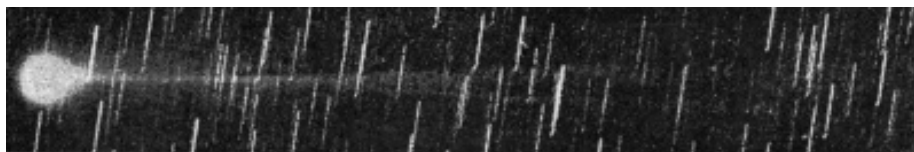

Gale's Comet of 1894 (photographed by Barnard)

Mass and Density.—So small are the masses of comets that only estimates can be given as compared with the mass of the earth. Comets have in certain instances approached very near to lesser bodies of the solar system; but while cometary orbits and motions have been greatly disturbed thereby, no change has been observed in the motion of satellites or other bodies near which a comet has passed. So this mass must be slight. Probably no comet's mass is so great as the $\frac{1}{100000}$ part of the earth's; but even if only one third of this, it would still equal a ball of iron 100 miles in diameter. If the mass of comets is so small, while their volume is so vast, what must be the density of these bodies? For the density is equal to the mass

divided by the volume, and comets must, therefore, be exceedingly thin and tenuous. On those rare occasions when stars have been observed through the tail of a comet, although it may be millions of miles in thickness, still no diminution of the star's luster has been perceived. Even through the denser coma the light of a star passes undimmed; though the star's image, if very near the comet's nucleus, may be rendered somewhat indistinct. The air pump is often used to produce an approach to a perfect vacuum; but in a cubic yard of such vacuum there would be many hundred times the amount of matter in a cubic yard of a comet's head.

Passing through a Comet's Tail.—Curious as it may seem, these enormous tails are in actual mass so slight that thrusting the hand into their midst would bring no recognition to the sense of touch. Collision would be much like an encounter with a shadow. Comets' tails are excessively airy and thin, or, as Sir John Herschel remarks, possibly only an affair of pounds or even ounces.

The mass of a comet's head may be large or small; it may not be more than a very large stone, or in the case of the larger comets it is perfectly possible that the mass of the head should be composed of an aggregation of many hundreds or even thousands of small compact bodies, stony and metallic. Usually the speed is

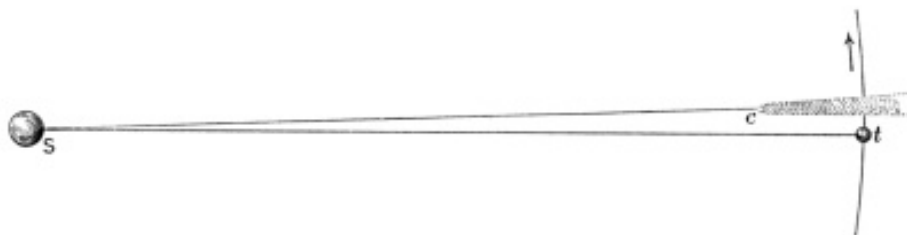

Earth about to pass through Tail of Comet of 1861

so great that the comet itself would be dissipated into vapor on experiencing the shock of collision with any of the planets. In at least two instances it is known that the earth actually passed through the tail of a comet, once on 30th June, 1861. The figure shows positions of sun (*S*), head of comet (*c*), and earth (*t*), just before our planet's plunge into the diaphanous tail. But we came through without being in the least conscious of it, except from calculations of the comet's position.

Collision with a Comet.—As the orbits of comets lie at all possible inclinations to the earth's path, or ecliptic, and as the motion of these erratic bodies may be either direct or retrograde, evidently it is entirely possible that our planet may some time collide with a comet, because these bodies

exist in space in vast numbers. As but one collision is likely to take place every 15,000,000 years, the chances are immensely against the happening of such an event in our time, and comets are not dangerous bodies. 'If one should shut his eyes and fire a gun at random in the air, the chance of bringing down a bird would be better than that of a comet of any kind striking the earth.'

However, should the head of a large comet collide squarely with our globe—the consequences might be inconceivably dire: probably the air and water would be instantly consumed and dissipated, and a considerable region of the earth's surface would be raised to incandescence. But consequences equally malign to human interests might result from the much more probable encounter of the earth's atmosphere with solid particles of a large hydrocarbon comet: it might well happen that diffusion of noxious gases from sudden combustion of these compounds would so vitiate the atmosphere as to render it unsuitable for breathing. In this manner, while the earth itself, its oceans, and even human habitations, might escape unharmed, it is not difficult to see how even a brush from the head of a large comet might cause universal death to nearly all forms of animal existence.

Origin of Comets.—The origin of comets is still shrouded in mystery. Probably they have come from depths of the sidereal universe, and so are entirely extra-solar in origin. Arriving apparently from all points of space in their journey from one star to another, they wheel about the sun somewhat like moths round a candle. Sometimes, as already shown, they speed away in a vast ellipse, with the promise of a future visit, though at some date which cannot be accurately assigned. Sometimes they continue upon interstellar journeys of such vast parabolic dimensions, perhaps round other suns, that no return can ever be expected. Probably the comets are but chips in the workshop of the skies, mere waste pieces of the stuff that stars are made of. It has been urged, too, that some comets may have originated in vaporous materials ejected by our own sun, or the larger planets of our system; but here we tread only the vast fields of mere conjecture, tempting, though unsatisfying.

Disintegration of Comets.—Every return to perihelion appears to have a disintegrating effect upon a comet. In a few cases this process has actually been taking place while under observation; for example, the lost Biela's comet in 1846, the great comet of 1882, and Brooks's comet of 1889, the heads of which were seen either to divide or to be divided into fragments. Groups of comets probably represent a more complete disintegration.

For example, the comets of 1843, 1880, 1882, and 1887 travel tandem, and originally were probably one huge comet. In the case of still other comets, this disintegration has gone so far that the original cometary mass is now entirely obliterated. Instead of a comet, then, there exists only a cloud of very small fragments of cometary matter, too small, in fact, to be separately visible in

space. Such interplanetary masses, originally single comets of large proportions, have by their repeated returns to the sun been completely shattered by the oft-renewed action of disrupting forces; and all that is now left of them is an infinity of meteoric particles, trailing everywhere along the original orbit. The astronomer becomes aware of the existence of these small bodies only when they collide with our atmosphere, sometimes penetrating even to the surface of the earth itself.

Meteors, Shooting Stars, and Meteorites.—Particles of matter thought to have their origin in disintegrated comets, and moving round the sun in orbits of their own, are called *meteors*. In large part, our knowledge of these bodies is confined to the relatively few which collide with the earth. The energy of their motion is suddenly converted into heat on impact with the atmosphere, and friction in passing swiftly through it. As a rule, this speedily vaporizes their entire substance, the exterior being brushed off by the air as soon as melted, often leaving a visible train in the sky. The luminous tracks pass through the upper atmosphere, few if any meteors appearing at greater heights than 100 miles, and few below 30 miles. These paths, if very bright, can be recorded with great precision by photography as Wolf, Barnard, and Elkin have done. As the speed of meteors through the air is comparable with that of our globe round the sun, we know that their motion is controlled by the sun's attraction, not the earth's.

Very small meteors, sometimes falling in showers, are frequently called *shooting stars*, but the late Professor Newton's view is gradually gaining ground, that there is no definite line of distinction. The shooting stars are thought to be very much smaller than meteors, because they are visible for only a second or two, and disappear completely at much greater heights than the meteors do. Many millions of them collide with our atmosphere every day, and are quickly dissipated. Although the average of them are not more massive than ordinary shot, their velocity is so great that all organic beings, without the kindly mantle of the air (were it possible for such to live without it) would be pelted to death. If a meteor passes completely through the atmosphere, and reaches the surface of the earth, it becomes known as a meteorite. Many thousand pounds of such interplanetary material have been collected from all parts of the earth, and the specimens are jealously preserved in cabinets and museums, the most complete of which are in London, Paris, and Vienna. Remarkable collections in the United States are at Amherst College, Harvard and Yale Universities, the National Museum at Washington, and the museums of Chicago and New York.

Meteors most Abundant in the Morning.—Run rapidly in a rainstorm: the chest becomes wetter than the back, because of advance of the body to meet the drops. In like manner, the forward or advance hemisphere of the earth, in its motion round the sun, is pelted by more meteors than any other portion. As every part of the earth is turned toward the radiant during the day of 24 hours,

it is obvious that the most meteors will be counted at that hour of the day when the dome of the sky is nearly central around the general direction of our

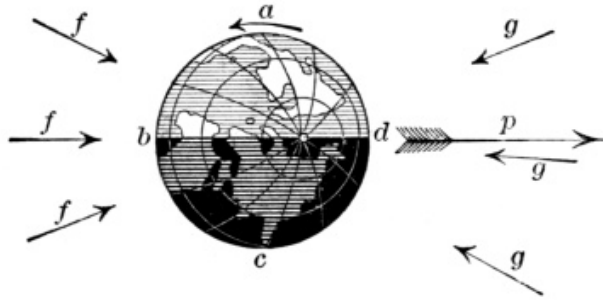

When Meteors are most Abundant

direction *dp*, indicated by the great arrow. So the hemisphere *adc* is advancing to meet the meteors which seem to fall from the directions *ggg*. If we suppose meteoric particles evenly distributed throughout the shoal, the number becoming visible by collision with our atmosphere will increase from midnight onward to six in the morning, provided the season is such that dawn does not interfere. From noon at *a* to sunset at *b*, there would be a gradual decrease, with the fewest meteors falling from the directions *fff*, upon the earth's rearward hemisphere, *abc*. Also, as to time of the year, it is well known that our globe encounters about three times as many shooting stars in passing from aphelion to perihelion as from perihelion to aphelion.

motion about the sun; in other words, when apex of earth's way is nearest to the zenith. Recalling the figures on pages 117–118, it is apparent that this takes place about sunrise; and in the adjacent illustration, where the sun is above the earth, and illuminating the hemisphere *abd*, it is sunrise at *d*, and the earth is speeding through space in the

Radiant Point.—On almost any clear, moonless night, especially in April, August, November, and December, a few moments of close watching will show one or more shooting stars. Ordinarily, they appear in any quarter of the sky; and on infrequent occasions they streak the heavens by hundreds and thousands, for hours at a time, as in November of 1799 and 1833. These are known as meteoric showers. Careful watching has revealed the very important fact, that practically all the luminous streaks of a shower, if prolonged backward, meet in a small area of the sky which is fixed among the stars. Ar-

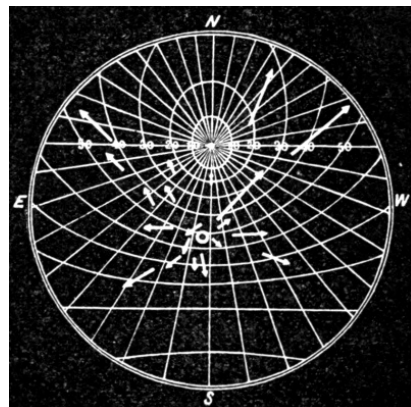

To Illustrate the Radiant Point

rows in the following figure represent the visible paths of 20 meteors, and the direction of their flight. It is clear that lines drawn through them will nearly all strike within the ring. This area is technically known as the radiant point, or simply the radiant. Divergence from it in every direction is only apparent—a mere effect of perspective, proving that meteors move through space in parallel lines. The radiant is simply the vanishing point. Notice that the luminous paths are longer, the farther they are from the radiant; if a meteor were to meet the earth head on, its trail would be foreshortened to a point, and charted within the area of the radiant itself. About 300 such radiant points are now known, of which perhaps 50 are very well established. The constellation in which the radiant falls gives the name to the shower; so there are Leonids and Perseids, Andromedes and Geminids, and the like.

List of Principal Meteor Showers.—In table 15.1 is given a short list of the chief meteoric displays of the year, according to Denning, a prominent English authority:—

Table 15.1: ANNUAL SHOWERS OF METEORS

NAME OF SHOWER	POSITION OF RADIANT		DATE OF MAXIMUM	DURATION IN DAYS
	R. A.	DECL.		
Quadrantids	15 h. 19 m.	N. 53°	Jan. 2	2
Lyrids	17 59	N. 32	April 18	4
Eta Aquarids . . .	22 30	S. 2	May 2	8
Delta Aquarids .	22 38	S. 12	July 28	3
Perseids	3 4	N. 57	Aug. 10	35
Orionids	6 8	N. 15	Oct. 19	10
Leonids	10 0	N. 23	Nov. 13	2
Andromedes	1 41	N. 43	Nov. 26	2
Geminids	7 12	N. 33	Dec. 7	14

When more than one radiant falls in any constellation, the usual designation of the nearest star is added, to distinguish between them.

Paths of Meteors.—Repeated observation of the paths of meteors belonging to any particular radiant soon establishes the fact that showers recur at about the same time of the year. Also in a few instances the shower is very prominently marked at intervals of a number of years. So it has become possible to predict showers of meteors, which on several occasions have been signally verified. Conspicuously so is the case of the shower of

November, 1866, which came true to time and place; but the prediction of a like shower in 1899–1900 was only partly verified. The periodic time of these meteors is $33\frac{1}{4}$ years.

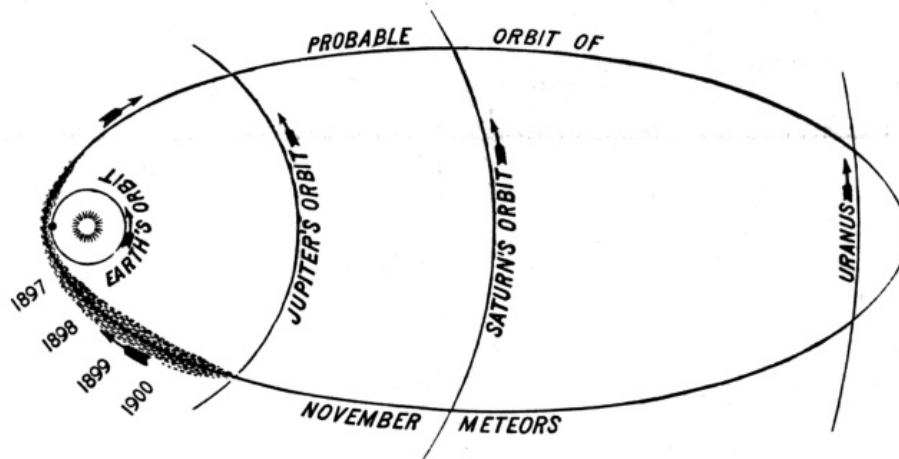

Orbit of Comet I (1866) and of the November Meteors

The position of their radiant among the stars, and the direction in which the meteors are seen to travel, has afforded the means of calculating the size and shape of their orbit, and just where it lies in space. Figure 15.21 shows the orbit of the Leonids, or November meteors, as related to the paths of the planets, and it is evident that these bodies, although they pass at a distance of 100,000,000 miles from the sun at their perihelion, recede about $16\frac{2}{3}$ years later to a distance greater than that of Uranus. They are not aggregated at a single point in their orbit, but are scattered along a considerable part of it, called the 'Gem of the ring.' As the breadth of the gem takes more than two years to pass the perihelion point, which nearly coincides with the position of the earth in the middle of November, there will usually be two or three meteoric showers at yearly intervals, while the entire shoal is passing perihelion. Failure of this shower is probably due to planetary perturbations and secular dissipation of this meteoric stream.

Meteoric Orbits in Space.—But it must not be inferred from the figure here given that the Leonids travel in the plane of the planetary orbits; for, at the time when their distance from the sun is equal to that of the planetary bodies, they are really very remote from all the planets except the earth and Uranus. This is because of the large angle of 17° by which the orbit of the November meteors is inclined to the ecliptic. It stands in space as Figure 15.22 shows, being the lower one of the two orbits whose

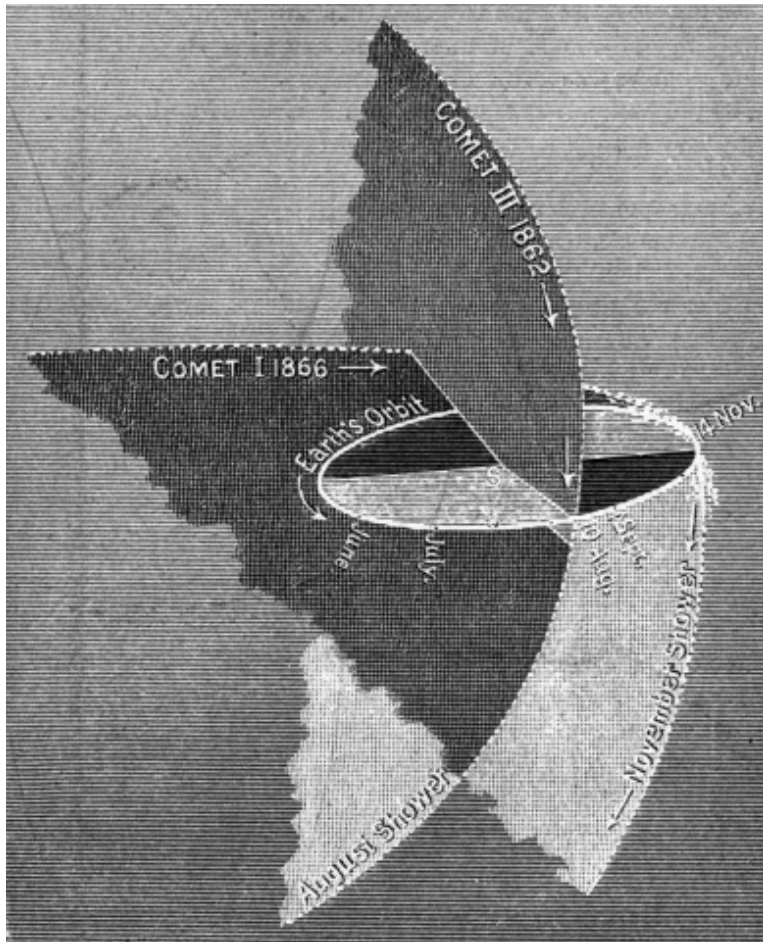

Perihelion Parts of Orbits of the August and November Meteor-showers

planes are cut off. Similarly, the upper and nearly vertical plane represents the position in space of another meteoric orbit, which intersects our path about 10th August. This shower is therefore known as the August shower; also these meteors are often called Perseids.

As shown by the arrows, both the Perseids and the Leonids travel oppositely to the planets; so that their velocity of impact with our atmosphere is compounded of their own velocity and the earth's also. This average speed for the Leonids, about 45 miles per second, is great enough to vaporize all meteoric masses within a few seconds; so it is unlikely that a meteoric product from the Leonids will ever be discovered. Impact velocity of the Andromedes is very much less, because they overtake the earth. In the case of meteorites, the velocity of ground impact probably never exceeds a few hundred feet per second, so great

is the resistance of the air; and several meteoric stones which fell in Sweden, 1st January, 1869, on ice a few inches thick, rebounded without either breaking it or being themselves broken.

Connection between Comets and Meteors.—Not long after the important discovery of the motion of meteors in regular orbits, an even more significant relation was ascertained: that the orbits of the Perseids and the Leonids are practically identical with the paths in which two comets are known to travel. The orbit of the Leonids is coincident with that of Tempel's comet (1866 I), and the Perseids pursue the same track in space with Swift's comet (known as 1862 III). The latter has a period of about 120 years, and recedes far beyond the planet Neptune. So do the meteors traveling in the same track. They are much more evenly distributed all along their path than the Leonids are; and no August ever fails of a slight sprinkle, although the shorter nights in our hemisphere often interfere with the display.

What are Meteors?—Several other meteor swarms and comets have been investigated with a like result; so the conclusion is now well established that these meteors, and probably all bodies of that nature, are merely the shattered residue of former comets. This important theory is confirmed, whether we look backward in the life of a comet, or forward: if backward, comets are known to disintegrate, and have indeed been 'caught in the act'; if forward, our expectation to find the disruption farther advanced in the case of some comets and meteors than others is precisely confirmed by the facts regarding different showers. Then, too, as will be shown in a later paragraph, the spectra of meteorites vaporized and photographed in our laboratories are practically identical with the spectra of the nuclei of comets. The conclusion is, therefore, that these latter are nothing more than a compact swarm or shoal of meteoric particles, vaporized in their passage through space, under conditions not yet fully understood. The practical identity of composition between comets and meteors had long been suspected, but it was not completely confirmed until 27th November, 1885, when meteorites which fell to the earth from a shower of Bielids were picked up in Mexico, and chemical and physical investigation established their undoubted nature as originally part of the lost Biela's comet.

Falls of Meteorites.—In general the meteorites are divided into two classes: meteoric stones and meteoric irons. Falls of the stony meteorites have been much oftener seen than actual descents of masses of meteoric iron. The most remarkable fall ever seen took place on 10th May, 1879, in Iowa, the heaviest stone weighing 437 pounds. This is two thirds the weight of the largest meteoric stone ever discovered, though not actually seen to fall. It was found in Hungary in 1866, and is now part of the Vienna collection.

The iron masses are often much heavier: the 'signet' meteorite, a complete ring found in Tucson, Arizona, and now in the United States National Museum at Washington, weighs 1400 pounds; a Texas meteorite, now part of the Yale collection, weighs 1635 pounds; and a Colorado meteorite in the Amherst collection weighs 437 pounds. But although the cabinets contain hundreds of specimens of meteoric irons, only eight or ten have actually been seen to fall.

Of these, the largest one fell in Arabia in 1865, and its weight is 130 pounds. It is now in the British Museum. The average velocity of meteors is 35 miles per second. Their visibility begins at an altitude of about 70 miles, and they fade out at half that height. The work done by the atmosphere in suddenly checking their velocity appears in large part as heat which fuses the exterior to incandescence, and leaves them, when cooled, thinly encrusted as if with a dense black varnish. The iron meteorites, not reduced by rust, are invariably covered with deep pittings or thumb marks. Meteorites are always irregular in form, never spherical; and the pittings are in part due to impact of minute aerial columns which resist their swift passage through the air.

Analysis of the Meteorites.—Meteoric iron is an alloy, containing on the average ten per cent of nickel, commingled with a much smaller amount of cobalt, copper, tin, carbon, and a few other elements. Meteoric iron is distinguishable from terrestrial irons by means of the 'Widmannstätten figures,' which etch themselves with acids upon the polished metallic surface—a test which rarely fails. The illustration shows these figures of their true size, as it was made from a transfer print from the actual etched surface of a meteorite in the Amherst collection. In meteoric stones, chemical analysis has revealed the presence of about one third of all the elemental substances recognized in the earth's crust; among them the elements found in meteoric irons, also sulphur, calcium, chlorine, sodium, and many others.

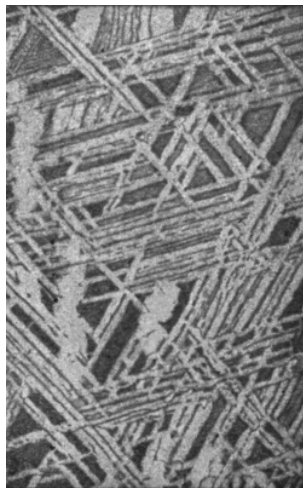

Widmannstätten Figures

The minerals found in meteoric stones are those which abound in terrestrial rocks of igneous or volcanic origin, like traps and lavas. Carbon sometimes is found in meteorites as diamond. The analysis of meteorites has brought to light a few compounds new to mineralogy, but has not yet led to the discovery of any new element; and the study of meteorites is now the province of the crystallographer,

the chemist, and the mineralogist, rather than the astronomer. Even the most searching investigation has so far failed to detect any trace of organic life in meteorites.

Occlusion is the well-known property of a metal, particularly iron, by which at high temperatures it absorbs gases, and retains them until again heated red hot. Hydrogen, carbonic oxide, and nitrogen are usually present in iron meteorites as occluded gases, also, in very small quantities, the light gas, newly discovered, called helium. In 1867, during a lecture on meteors by Graham, a room in the Royal Institution, London, was lighted by gas brought to earth in a meteorite from interplanetary space. We have now traversed the round of the solar system; it remains only to consider the bodies of the sidereal system, and the views held by philosophers concerning the progressive development of the material universe.



Halley's Comet, May, 1910 (from a photograph by Ellerman in the Hawaiian Islands)

Chapter XVI

The Stars and the Cosmogony

Our descriptions of heavenly bodies thus far have concerned chiefly those belonging to the solar system. We found distance growing vast beyond the power of human conception, as we contemplated, first the neighborly moon, then the central orb of the system 400 times farther away, and finally Neptune, 30 times farther than the sun,—not to say some of the comets whose paths take them even remoter still. But outside of the solar system, and everywhere surrounding it, is a stellar universe the number of whose countless hosts is in some sense a measure of their inconceivable distance from our humble abode in space.

The Sidereal System.—All these bodies constitute the sidereal system, or the stellar universe. It comprises stars and nebulæ; not only those which are visible to the naked eye, but hundreds of thousands besides, so faint that their existence is revealed only by the greatest telescopes and the most sensitive photographic plates. Remoteness of the stars at once forbids supposition that they are similar in constitution to planets, shining by light reflected from the sun as the moon and planets do. Even Neptune, on the barriers of our system, is too faint for the naked eye to grasp his light. But the nearest fixed star is about 9000 times more distant. So the very brightness of the lucid stars leads us to suspect that they at least must be self-luminous like the sun; and when their light is analyzed with the spectroscope, the theory that they are suns is actually demonstrated. It is reasonable to conclude, then, that the sun himself is really a star, whose effulgence, and importance to us dwellers on the earth, are due merely to his proximity. The figure below will help this conception: for if we recede from the sun even as far as Neptune, his disk will have shrunk almost to a point, though a dazzling one. Were this journey to be continued to the nearest star, our sun would have dwindled to the insignificance of an ordinary star.

The Magnitudes of Stars.—While stars as faint as the sixth magnitude can just be seen by the ordinary eye on a clear dark night, still other

and fainter stars can be followed with the telescope far beyond this limit,

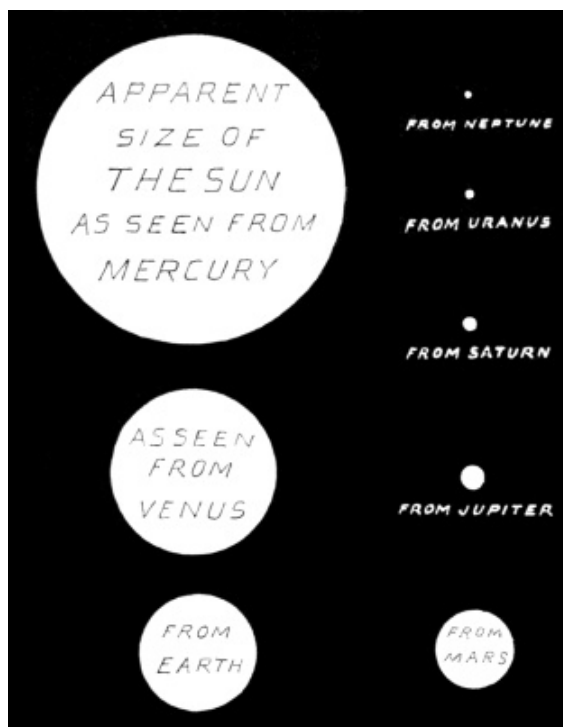

Our Sun but a Brilliant Star as seen from Neptune

to the fifteenth magnitude and even farther by the largest instruments. Division into magnitudes, although made arbitrarily, is a classification warranted by time, and use of many generations of astronomers. Brightness of stars decreases in geometric proportion as the number indicating magnitude increases; the constant term being $2\frac{1}{2}$. Thus, an average star of the first magnitude is $2\frac{1}{2}$ times brighter than one of the second magnitude; a second magnitude star gives $2\frac{1}{2}$ times more light than one of the third magnitude, and so on. At the observatory of Harvard College, Pickering, its director, has devoted

many years to determination of stellar magnitudes with the meridian photometer, a highly accurate instrument of his devising, by which the brightness of any star at culmination may be compared directly with Polaris as a standard. Brightest of all the stars is Sirius, and as no others are so brilliant, strictly he ought perhaps to be the only first magnitude star. But many fainter than Sirius are ranked in this class, three of them so bright that their stellar magnitude is negative, as below. Decimal fractions express all gradations of magnitude. Even the surpassing brilliancy of the sun can be indicated on the same scale; the number -25.4 expresses his stellar magnitude.

The Brightest Stars.—Twenty stars are rated of the first magnitude; half of them are in the northern hemisphere of the sky. They are given in Table 16.1.

These stars culminate at different altitudes varying with their declination, and at different times throughout the year, which you may find from charts of the constellations (pp. 53–56).

Number of the Stars.—Besides twenty stars of the first magnitude,

Table 16.1: THE BRIGHTEST STARS

ORDER OF BRIGHTNESS	STELLAR MAGNITUDE	STARS' NAMES
1	-1.4	α Canis Majoris (<i>Sirius</i>)
2	-0.8	α Argûs (<i>Canopus</i>) *
3	-0.1	α Centauri *
4	0.1	α Aurigæ (<i>Capella</i>)
5	0.2	α Boötis (<i>Arcturus</i>)
6	0.2	α Lyræ (<i>Vega</i>)
7	0.3	β Orionis (<i>Rigel</i>)
8	0.4	α Eridani (<i>Achernar</i>) *
9	0.5	α Canis Minoris (<i>Procyon</i>)
10	0.7	β Centauri *
11	0.9	α Orionis (<i>Betelgeux</i>)
12	0.9	α Crucis *
13	0.9	α Aquilæ (<i>Altair</i>)
14	1.0	α Tauri (<i>Aldebaran</i>)
15	1.1	α Virginis (<i>Spica</i>)
16	1.2	α Scorpii (<i>Antares</i>)
17	1.2	β Geminorum (<i>Pollux</i>)
18	1.3	α Piscis Australis (<i>Fomalhaut</i>)
19	1.3	α Leonis (<i>Regulus</i>)
20	1.4	α Cygni (<i>Deneb</i>)

* Invisible in our middle northern latitudes.

not only are there nearly six thousand of lesser magnitude visible to the naked eye, likewise many hundreds of thousands visible in telescopes of medium size, but also millions of stars revealed by the largest telescopes. From careful counts, partly by Gould, the number of stars of successive magnitudes is found to increase nearly in geometric proportion, as shown in Table 16.2.

Any glass of two inches aperture should show all these stars. But in order to discern all the uncounted millions of yet fainter stars, we need the largest instruments, like the Lick and the Yerkes telescopes. Their approximate number has been ascertained not by actual count, but by estimates based on counts of typical areas scattered in different parts of the heavens. The number of stars within reach of our present telescopes perhaps exceeds 125 millions. But the telescope by itself, no matter how powerful, is unable

Table 16.2:

1st magnitude	20	6th magnitude	5000
2d	65	7th	20,000
3d	200	8th	68,000
4th	500	9th	240,000
5th	1400	10th	720,000

to detect any important difference between these faint and multitudinous luminaries; seemingly all are more alike than peas or rice grains to the naked eye. There is good reason for believing that the dark or non-luminous stars are many times more numerous than the visible ones, and modern research has made the existence of many such invisible bodies certain.

Total Light from the Stars.—Argelander, a distinguished German astronomer, made a catalogue and chart of all the stars of the northern hemisphere increased by an equatorial belt, one degree in width, of the southern stars. His limit was the $9\frac{1}{2}$ magnitude, and he recorded rather more than 324,000 stars in all. Accepting a sixth magnitude star as the standard, and expressing in terms of it the light of all the lucid stars registered by Argelander, they give an amount of light equivalent to 7300 sixth magnitude stars. But calculation proves also that the telescopic stars of this extensive catalogue yield more than three times as much light as the lucid ones do. The stars, then, we cannot see with the naked eye give more light than those we can, because of their vastly greater numbers. If, now, we suppose the southern heavens to be studded just as thickly as the northern, there would be in the entire sidereal heavens about 600,000 stars to the $9\frac{1}{2}$ magnitude; and their total light has been calculated equal to $\frac{1}{80}$ that of the average full moon.

Colors of the Stars.—A marked difference in color characterizes many of the stars. For example, the polestar and Procyon are white, Betelgeux and Antares red, Capella and Alpha Ceti yellowish, Vega and Sirius blue. Among the telescopic stars are many of a deep blood-red hue; variable stars are numerous among these. In observing true stellar colors, the objects should be high above the horizon, for the greater thickness of atmosphere at low altitudes absorbs abundantly the bluish rays, and tends to give all stars more of an orange tint than they really possess. Colors are easier to detect in the case of double stars (page 451), because the components of many of these objects exhibit complementary colors; that is, colors which produce white light when combined. If components of a 'double' are of about the same magnitude, their color is usually the same; if the companion is much fainter, its color is often of complementary tint, and always nearer the blue end of the spectrum. Complementary colors

are better seen with the stars out of focus. Following are a few of these colored double stars:—

η Cassiopeiaë,	yellow and purple,	4 mag.	$7\frac{1}{2}$ mag.
γ Andromedæ,	orange and green,	$3\frac{1}{2}$	$5\frac{1}{2}$
ι Cancrî,	orange and blue,	$4\frac{1}{2}$	6
α Herculis,	orange and green,	3	6
β Cygni,	yellow and blue,	3	7

There is some evidence that a few stars vary in color in long periods of time; for example, two thousand years ago Sirius was a red star, now it is bluish white. Any significance of color as to age or intensity of heat is not yet recognized; rather is it probably due to variant composition of stellar atmospheres.

Star Catalogues and Charts.—When you consult a gazetteer you find a multitude of cities set down by name. Corresponding to each is its latitude, or distance from the equator, and its longitude, or arc distance on the equator, measured from a departure point or prime meridian. These arcs are measured on the surface of our earth. Turning, then, to the map, you find the city in question, and perhaps many neighboring ones set down in exact relation to it. Precisely in a similar manner all the brighter stars of the sky are registered in their true relations one to another, on charts and photographic plates. These will be accurate enough for many purposes, but not for all. When a higher precision is required, one must consult those gazetteers of the sky known as star catalogues. Set down in them will be found the coördinates of a star; that is, its right ascension and declination, the counterparts of terrestrial longitude and latitude. But we shall soon observe this peculiar difference between longitude on the earth and right ascension in the sky: the star's right ascension will (in nearly all cases) be perpetually increasing, while the longitude of a place remains always the same. This perpetual shifting of the stars in right ascension is mostly due to precession. It is as if Greenwich or Washington were constantly traveling westward, but so slowly that only in 26,000 years would it have traveled all the way round the globe.

Precession and Standard Catalogues.—It was Hipparchus (B.C. 130) who first discovered this perpetual and apparent shifting of all the stars. And partly for this reason he made a catalogue (the first one ever constructed) of 1080 stars, so that the astronomers coming after him might, by comparing his map and catalogue with their own, discover what changes, if any, are in progress among the stellar hosts. No competitor appeared in the field, until the 15th century, when the second catalogue was constructed, by Ulugh-Beg (A.D. 1420), an Arabian astronomer. Since his day vast improvements have been made in methods of observing the stars, and in

calculating observations of them. There are now about 100 large catalogues of stars, constructed by astronomers of both hemispheres; and the place of every star in the entire celestial sphere revealed by telescopes of medium dimension will soon be determined with astronomical precision. Several of the larger government observatories prepare a catalogue of stars every year from their observations; and these again are combined into other and more accurate catalogues (called standard catalogues), especially of the zodiacal stars. These afford average or mean positions of stars for the beginning of a particular year, called the epoch of the catalogue. Positions for any given dates are obtained by bringing the epoch forward, and farther correcting for precession, aberration, and nutation (pages 130, 164, and 390). The mean position so corrected becomes the apparent place. The chief American authorities on standard stellar positions are Newcomb, Boss, and Safford.

Photographic Charts of the Entire Heavens.—On proposal of David Gill, her Majesty's astronomer at the Cape of Good Hope, an international congress of astronomers met at Paris in 1887, and arranged for the construction of a photographic chart of the entire heavens. The work of making the charts has been allotted to 18 observatories, one third of which are located in the southern hemisphere. They are equipped with 13-inch telescopes, all essentially alike; and exposures are of such length as to include all stars to the 14th magnitude, probably more than 50 millions in all. Stars to the 11th magnitude inclusive (about 2,000,000) are to be counted and their positions measured and catalogued. Each photograph covers an area of four square degrees; and as duplicate exposures are necessary, the total number of plates will be not less than 25,000. The entire expense of this comprehensive map of the stars will exceed \$2,000,000. The observatories of the United States have taken no part in this coöperative programme; but by the liberality of Miss Bruce, the Observatory of Harvard College, which has a station in Peru also, has undertaken independently to chart in detail the more interesting regions of the entire heavens, with the Bruce photographic telescope, a photographer's doublet consisting of four lenses, each 24 inches in aperture. A section of a recent chart obtained with this great instrument is shown opposite. The plates are 14×17 inches; about two thousand will be required to cover the entire sky. On the original plate of which the illustration is part were counted no less than 400,000 stars. Also Kapteyn has measured and catalogued about 300,000 stars on plates taken at Capetown.

Proper Motions of the Stars.—If Ptolemy or Kepler or any great astronomer of the past were alive to-day, and could look at the stars, and constellations as he did in his own time, he would be able to discern no change whatever in either the brightness of the stars or their apparent positions relatively to each other. Consequently they seem to have been

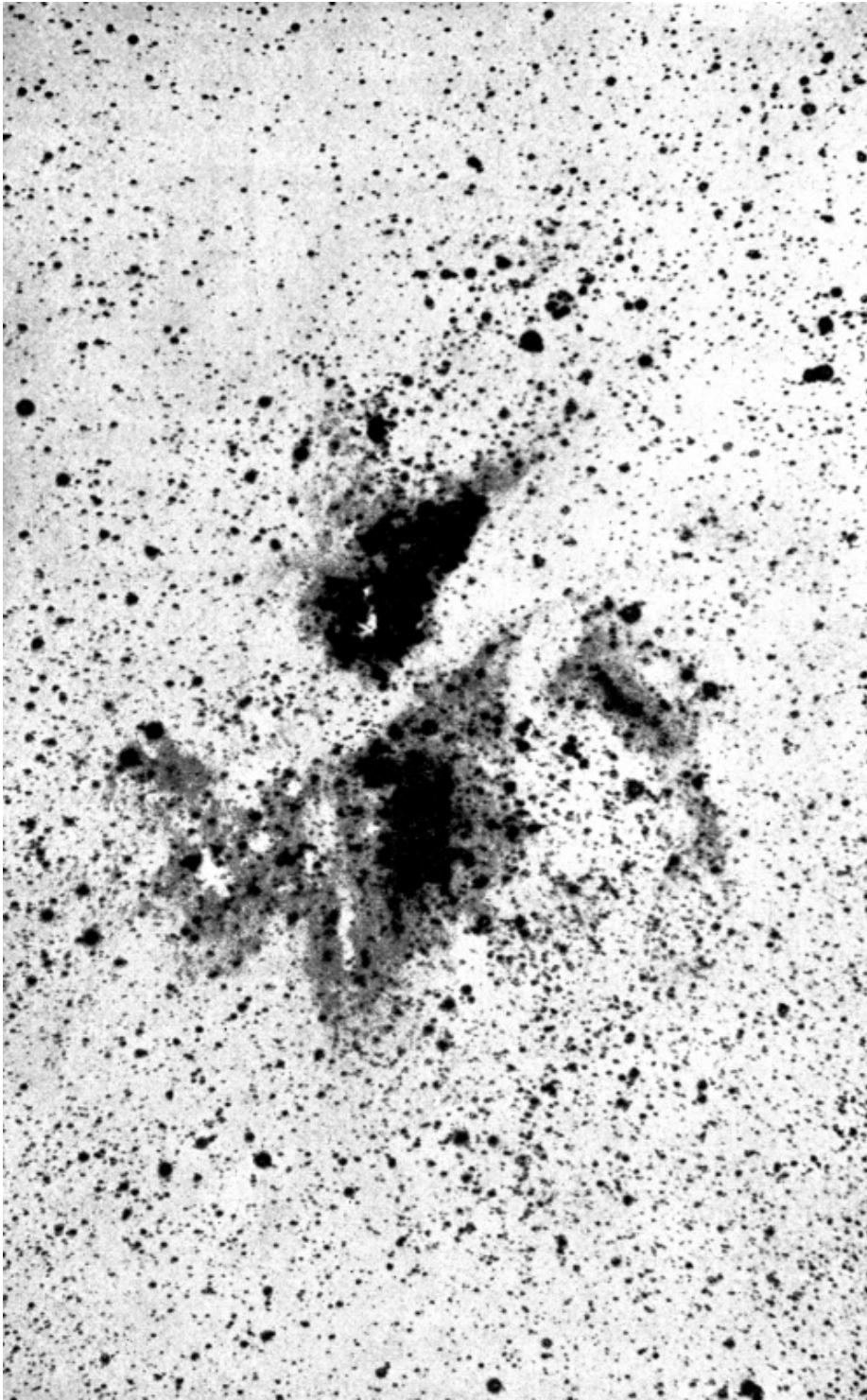

The Vicinity of η Carinae (Eta Argûs), R 10 h. 41 m., Decl. S. 59° (photographed by Bailey with the Bruce Telescope, 1896. Exposure 4 hours)

well named *fixed stars*. If, however, we compare closely the right ascensions and declinations of stars a century and a half ago with their corresponding

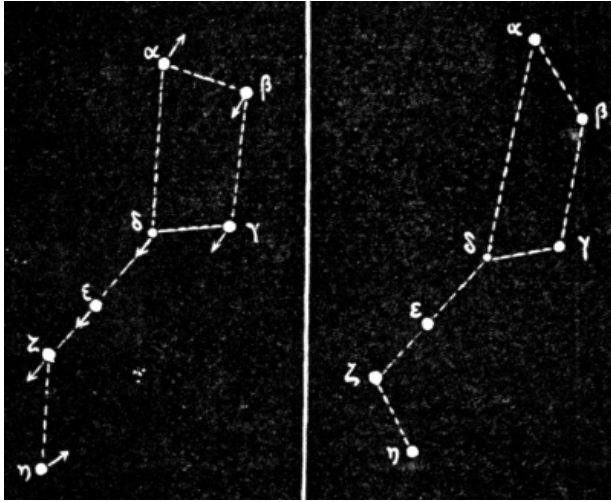

Ursa Major now, and after 400 Centuries

positions at the present day, we find that very great changes are taking place; but these changes relatively to the imaginary circles of the celestial sphere are in the main due to precessional motion of the equinox. A star's annual proper motion in right ascension is the amount of residual change in its right ascension in one year, after allowance for aberration, and motion of the equinox. The proper motion in declination may be similarly defined. Proper motion is simply an angular

change in position athwart the line of vision, and may correspond to only a small fraction of the star's real motion in space.

As a whole, proper motion of the brighter stars exceeds that of the fainter ones, because they are nearer to us; and proper motion is a combined effect of the sun's motion in space and of the stars among each other. Ultimately these two effects can be distinguished. Still, even the largest proper motion yet known, that of an orange yellow star of the eighth magnitude in the southern constellation of Pictor, is not quite $9''$; and about two centuries must elapse before it would seem to be displaced so much as the breadth of the moon. The average proper motion of first magnitude stars is about $0''.25$; and of sixth magnitude stars, only one sixth as great. Among European astronomers Auwers has contributed most to these critical studies, and Porter in America has published a catalogue of proper motions.

Secular Changes in the Constellations.—The accumulated proper motion of the stars of a given asterism will hardly change its naked-eye appearance appreciably within 2000 years. But when intervals of 15 to 20 times greater are taken, the present well-known constellation figures will in many cases be seriously distorted.

Particularly is this true of Cassiopeia, Orion, and Ursa Major. In the left-hand diagram above is shown the present asterism of the Dipper, to each star

of which is attached an arrow indicating the direction and amount of its proper motion in about 400 centuries. The companion diagram at the right is a figure of the same constellation (according to Proctor) after that interval has elapsed: though much distorted, it would be recognized as Ursa Major still. As indicated by the direction of the arrows, the extreme stars, Alpha and Eta, seem to move almost in the opposite direction from the others, and observations with the spectroscope confirm this result. As the spectra of the five intermediate stars are quite identical, it is likely that they originally formed part of a physically connected system. Most of the brighter stars of the Pleiades are also moving in one and the same direction, and this community of proper motion has received the name star drift.

Apex of the Sun's Way.—When riding upon the rear platform of a suburban electric car, where the ties are not covered under, observe that they seem to crowd rapidly together as the car swiftly recedes from them. If possible to watch from the front platform, precisely the opposite effect will be noticed: the ties

seem to open out and separate from each other just as rapidly. In like manner the stars in one part of the celestial sphere, when taken by thousands, are found to have a common element of proper motion inward toward a center or pole; while in the opposite region, they seem to be moving radially outward, as if from the hub and along the spokes of a wheel. This double phenomenon is explained by a secular motion of the sun through space, transporting his entire family of planets,



Earth's Helical Path in Space

satellites, and comets along with him. This hub or pole toward which the solar system is moving is called the *sun's goal*, or *the apex of the sun's way*; and determinations by L. Struve, Boss, Porter, and Dyson make it practically coincident with the star Vega. Similarly the point from which we are receding is known as the *sun's quit*, and it is roughly a point halfway between Sirius and Canopus. So vast is this orbit of the sun that no deviation

from a straight line is yet ascertained, although our motion along that orbit is about 12 miles every second.

This result is verified both by discussion of proper motions, and by finding the relative movement of stars 'fore and aft' by means of the spectroscope. As yet, however, there is no indication of a 'central sun,' a favorite hypothesis in the middle of the 19th century. This motion of the sun does not interfere with the relations of his family of planets to him; but simply makes them describe, as in the figure just given, vast spiral circumvolutions through interstellar space.

Stellar Motions in the Line of Sight.—From a bridge spanning a rivulet, whose current is uniform, we observe chips floating by, one every 15 seconds. Ascending the stream, we find their origin: an arithmetical youth on the bank has been throwing them into mid-stream at regular intervals, four chips to the minute. We interfere with his programme only by asking him first to walk down stream for two minutes, then to return at the same uniform speed; and to repeat this process several times, always taking care to throw the chips at precisely the same intervals as before. Returning to the bridge to observe, we find the chips no longer pass at intervals of 15 seconds as at first; but that the interval is less than this amount while the boy who tosses them is walking down stream, and greater by a corresponding amount while he is going in the opposite direction. By observing the deviation from 15 seconds, the speed at which he walks can be found. Similarly with the motions of stars toward or from the earth; the boy is the moving star, and the chips are the crests of light waves emanating from it. When the star is coming nearer, more than the normal number of waves reach us every second, and a given line in the star's spectrum is displaced toward the violet. Likewise when a star is receding, the same line deviates toward the red. This effect was first recognized in 1842 by Doppler, from whom comes the name 'Doppler's principle.' Research of this character is an important part of the programme at Greenwich (on the facing page), and at the Yerkes Observatory (page 7).

The spectral observation is an exceedingly delicate one; but by measuring the degree of displacement of stellar lines, as compared with the same lines due to terrestrial substances artificially vaporized (titanium is often used), the motions of many hundred stars have been ascertained. The limit of accuracy is a fraction of a kilometer per second. The observed radial velocities of stars not situated at the poles of the ecliptic, or near them, require a correction depending on the earth's orbital motion round the sun. So accurate, indeed, have these measurements become that the velocity of the earth in its orbit has been ascertained with such precision as to give a new and trustworthy value for the sun's parallax and

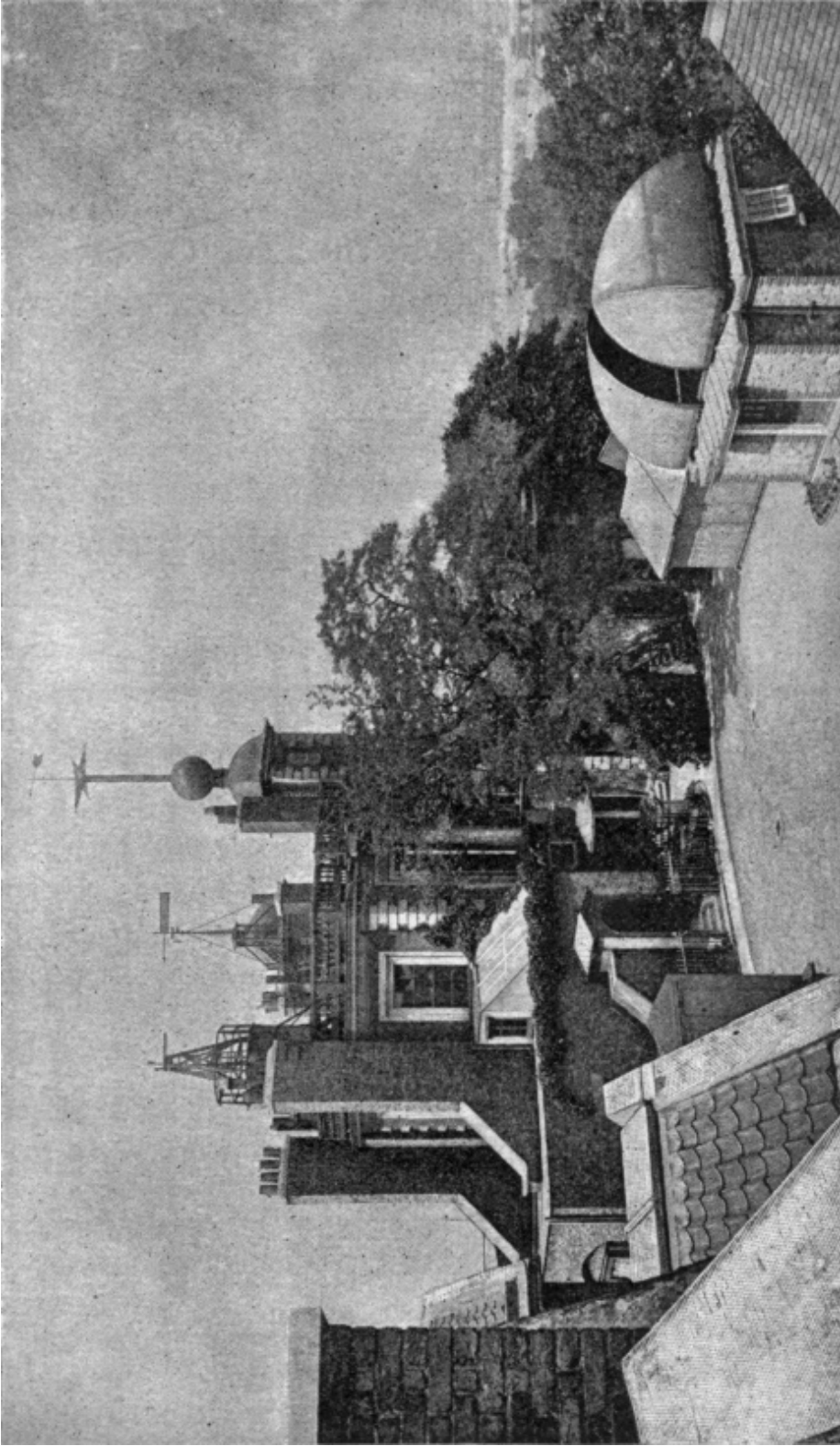

The Royal Observatory, Greenwich. W. H. M. Christie, F.R.S., Astronomer Royal

Founded by CHARLES THE SECOND in 1675, for the main purpose of advancing our knowledge of the movements of the heavenly bodies, in order to improve the means of finding the position of ships at sea. The work of the Royal Observatory now includes many other important lines as well.

its distance from the earth. The radial velocities of many stars are found to vary slowly, in some cases appearing to indicate orbital motion of their own.

Motion of the Solar System by Radial Velocities.—The early years of the 20th century saw the inception of a comprehensive plan for applying measures of radial velocity to solving the problem of the sun's motion in space—its precise direction and its exact velocity. By coöperation of many observatories possessing very powerful spectroscopes—Pulkowa in Russia, Potsdam in Germany, Cambridge in England, also among others the Lick and Yerkes Observatories in America,—the spectra of stars in all regions of the northern heavens are systematically recorded by photography. Also the southern stars were included by the Mills Expedition sent out in 1903 from the Lick Observatory to Santiago, Chile. Preliminary discussion of the line-of-sight measures confirms the result already given (page 431) for the apex of the sun's way (the star Vega), and the sun's velocity about 12 miles per second. The average velocity of stars so far observed is about 20 miles per second; but a few have been discovered with a motion three or four fold greater.

Relation of Brightness to Distance of the Stars.—Were the stars all of the same real size and brightness, their apparent magnitudes, combined with their direction from us, would make it possible to state their precise arrangement throughout the celestial spaces. But all assumptions of this character are unfounded, and lead to erroneous conclusions. The very little yet known about the real distances of the stars and their motions, when taken in connection with their apparent magnitudes, proves conclusively that many of the fainter stars are relatively near the solar system; also that several of the brighter stars are exceedingly remote, and therefore exceptionally large and massive. Apparent brightness, therefore, is no certain criterion of distance. This subject of investigation is so vast and intricate that very little headway has yet been securely made. What we really know may be put in a single brief sentence: Only as a very general rule is it true that the brighter stars are nearer and larger than the great mass of fainter ones; and to this rule are conspicuous and important exceptions. Our knowledge is rather negative than positive; and we may be certain that (1) the stars are far from equally distributed throughout space, and (2) they are far from alike in real brightness and dimensions.

How Stellar Distances are found.—Recall the instance of the earth and moon (page 210): we found the moon's distance from us by measuring her displacement among the stars, as seen from two observatories at the ends of a diameter of our globe, or as near its extremities as convenient. But this earth is so small, that, as seen from a star, even its entire diameter

would appear as an infinitesimal; we must therefore seek another base line. Only one is feasible; and although 25,000 times greater, still it is hardly long enough to be practicable.

Imagine the earth replaced by a huge sphere, whose circle equals our orbit round the sun. From the ends of a diameter, where we are at intervals of six months, we may measure the displacement of a star, just as we measured the displacement of the moon from the two observatories. We find, then, that half this displacement represents the star's parallax, just as half the moon's displacement gave the lunar parallax. And just as in the case of moon, sun, and planets we employ the term *diurnal parallax*, so in the case of stars we call *annual parallax* the angle at the star subtended by the radius of earth's orbit. Measurement of a star's annual parallax is one of the exceedingly difficult problems that confront the practical astronomer; so small is the angle that its measurement is much as if a prisoner who could only look out of the window of his cell were given instruments of utmost precision and compelled to ascertain the distance of a mountain 20 miles away.

A Star's Parallaxic Ellipse.—Stand a book on the table, and place the eye about two feet from the side of it. Hold the point of a pen or pencil steadily, at distances of about 5, 10, and 20 inches from the eye, and between it and the book. For each position of the pencil move the head around in a nearly vertical circle about two inches in diameter, noticing in

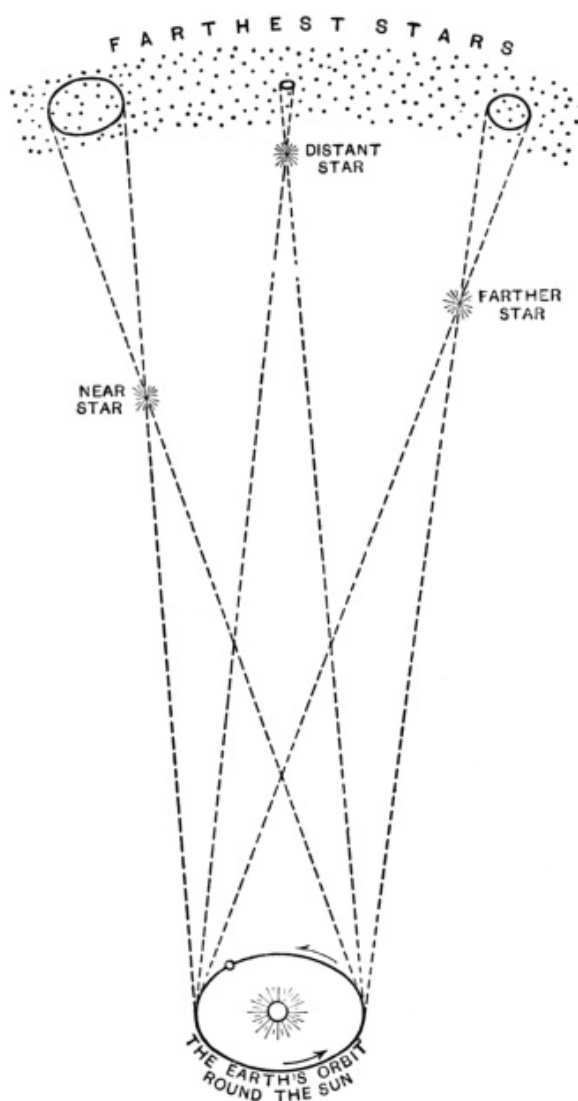

The Nearest Star describes the Largest Apparent Ellipse among the Farthest Stars

noticing in

each case the size of the circle which the pen point appears to describe when projected on the book. This conclusion is quickly reached: the farther the pencil from the eye, the smaller this circle. Now imagine the eye replaced by the earth in its orbit (as at the bottom of the diagram), the pencil by the three stars shown, and the book by the farthest stars. Evidently the earth by traveling round the sun makes the stars appear to describe elliptic orbits whose size is precisely proportioned inversely to their distance from the solar system. The eccentricity of the parallactic ellipse of a star is exactly the same as that of its aberration ellipse already figured on page 142: a star at the pole of the ecliptic describes a circle, and those situated in the ecliptic simply oscillate forth and back in a straight line. Stars in intermediate latitudes describe ellipses whose eccentricities are dependent upon their latitude. There are these two important differences:

(1) in the aberration ellipse, the star is always thrown 90° forward of its true position, while in the parallactic ellipse, it is just 180° displaced; (2) the major axis of the aberration ellipse is the same for all stars, but in the parallactic ellipse its length varies inversely with the distance of the star. Measurement of the major axis of this ellipse affords the means of ascertaining how far away the star is, because the base line is the diameter of the earth's orbit. This is called the *differential method*, because it determines, not the star's absolute parallax, but the difference between its parallax and that of the remotest star, assumed to be zero. Researches on stellar distances have been prosecuted by Gill at Capetown and Elkin at Yale Observatory with a high degree of accuracy by the heliometer.

The Distance of 61 Cygni.—The star known as 61 Cygni has become famous, because it is the first star whose distance was ever measured. This great

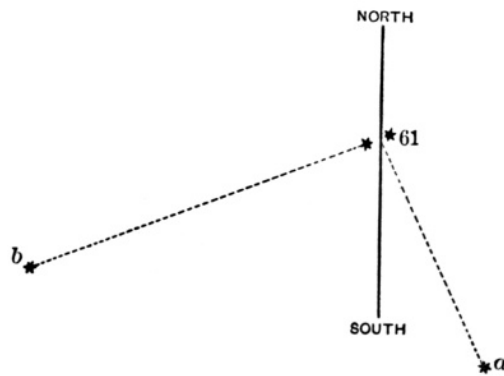

Bessel's Measures of Distance of 61 Cygni

step in our knowledge of the sidereal universe was taken about 1840 by the eminent German astronomer Bessel, often called the father of practical astronomy, because he introduced many far-reaching improvements conducing to higher accuracy in astronomical methods and results. This star is a double star, standing at an angle with the hour circle (north-south), as the diagram shows. Two small stars are in the same field of view, *a* and *b*, nearly at right angles in their direction from the double star; and Bessel had reason for believing that they were vastly farther

away than 61 Cygni itself. So at opposite seasons of the year he measured with the heliometer the distances between each of the components of 61 Cygni and both the stars *a* and *b*. What he found on putting his measures together was that these apparent distances change in the course of the year; and that the

nature of the change was exactly what the star's position relatively to the ecliptic led him to expect. The measured amount of that change, then, was the basis of calculation of the star's distance from our solar system. Within recent years photography has been successfully applied to researches of this character, with many advantages, including increased accuracy of the results obtained.

Illustration of Stellar Distances.—The nearest of all the fixed stars is Alpha Centauri, a bright star of the southern hemisphere. Its parallax is $0''.75$, and it is 275,000 times more distant from our solar system than the sun is from the earth. But there is little advantage in repeating a mere statement of numbers like this. Try to gain some conception of its meaning. First, imagine the entire solar system as represented by a tiny circle the size of the dot over this letter *i*. Even the sun itself, on this exceedingly reduced scale, could not be detected with the most powerful microscope ever made. But on the same scale the vast circle centered at the sun and reaching to Alpha Centauri would be represented by the largest circle which could be drawn on the floor of a room 10 feet square. Or the relative sizes of spheres may afford a better help. Imagine a sphere so great that it would include the orbits of all the planets of the solar system, its radius being equal to Neptune's distance from the sun. Think of the earth in comparison with this sphere. Then conceive all the stars of the firmament as brought to the distance of the nearest one, and set in the surface of a sphere whose radius is equal to the distance of that star from us. So vast would this star sphere be that its relation to the sphere inclosing the solar system would be nearly the same as the relation of this latter sphere to the earth. When studying the sun and the large planets, it seemed as if their sizes and distances were inconceivably great; but great as they are, even the solar system itself is as a mere drop to the ocean, when compared with the vastness of the universe of stars.

The Unit is the Light Year.—In expressing intelligently and conveniently a distance, the unit must not be taken too many times. We do not state the distance between New York and Chicago in inches, or even feet, but in miles. The earth's radius is a convenient unit for the distance of the moon, because it has to be taken only 60 times; but it would be very inconvenient to use so small a unit in stating the distances of the planets. By a convention of astronomers, the mean radius of our orbit round the sun is the accepted unit of measure in the solar system. Similarly the adopted unit of stellar distance is, not the distance of any planet nor the distance of any star, but the distance traveled by a light wave in a year. This unit is called the *light year*.

The velocity of light is 186,300 miles per second, and it travels from the sun to the earth in 499 seconds. The light year is equal to $63,000 \times 93,000,000$ miles, because the number of seconds in a year is about $499 \times 63,000$; or, the light year

Table 16.3: STELLAR DISTANCES AND PARALLAXES

STAR'S NAME	MAGNITUDE	APPROXIMATE [1900.0]			PROPER MO- TION	PARALLAX	DISTANCE IN—			
		R. A.		DECL.			LIGHT YEARS	TRIL- LIONS OF MILES		
		h.	m.	°	'	"	"			
α Centauri	-0.1	14	33	S.	60	25	3.67	0.75	$4\frac{1}{3}$	25
61 Cygni	6.1	21	2	N.	38	15	5.16	0.45	$7\frac{1}{5}$	43
Sirius	-1.4	6	41	S.	16	35	1.31	0.38	$8\frac{1}{2}$	50
Procyon	0.5	7	34	N.	5	29	1.25	0.27	12	71
Altair	0.9	19	46	N.	8	36	0.65	0.20	16	94
α^2 Eridani	4.4	4	11	S.	7	48	4.05	0.19	17	100
Groombridge 1830	6.5	11	47	N.	38	30	7.65	0.13	25	147
Vega	0.2	18	34	N.	38	41	0.36	0.12	27	158
Aldebaran	1.0	4	30	N.	16	18	0.19	0.10	32	191
Capella	0.1	5	9	N.	45	54	0.43	0.10	32	191
Polaris	2.1	1	23	N.	88	46	0.05	0.07	47	276
Arcturus	0.2	14	11	N.	19	41	2.00	0.02	160	950

is equal to $5\frac{7}{8}$ trillion miles. Obviously, as stellar parallax has a definite relation to distance, parallax must be related to the light year also: the distance of a star whose parallax is $1''$ is about $3\frac{1}{4}$ light years. So that, if we divide $3\frac{1}{4}$ by the parallax (in seconds of arc), we shall have the star's distance in light years.

Distances of Well-known Stars.—Although the parallaxes of hundreds of stellar bodies have been measured, only about 50 are regarded as well known. Twelve are given in Table 16.3, together with their corresponding distance in light years.

Most of these are bright stars, but a considerable number of faint stars have large parallaxes also. Relative distances and approximate directions from the solar system are shown in next illustration, for a few of the nearer and best determined stars. The scale is necessarily so small that even the vast orbit of Neptune has no appreciable dimension. The outer circle corresponds nearly to a parallax $0.''1$. The distances of many stars have been ascertained by Sir Robert Ball; also in America by Flint.

Dimensions of the Stars.—After we had found the distance of the sun and measured the angle filled by his disk, it was possible to calculate his true dimensions. But this simple method is inapplicable to the stars, because their distances are so vast that no stellar disk subtends an appreciable angle. Indirect

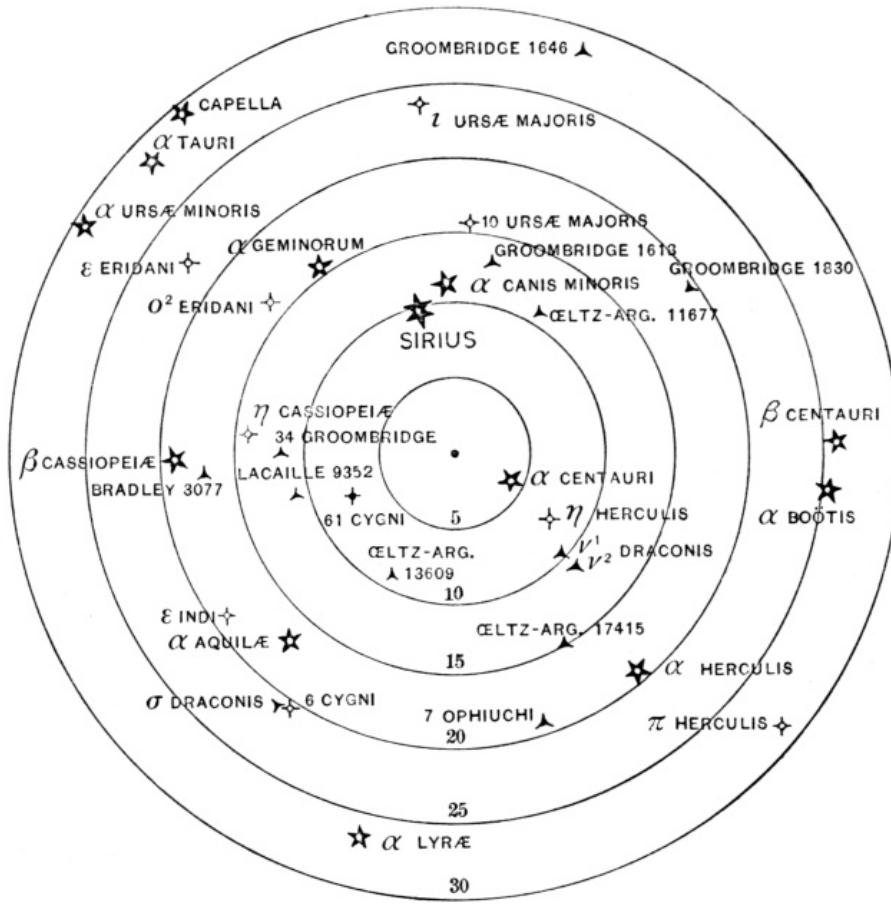

Distances of Stars from the Solar System in Light Years (according to Ranyard and Gregory)

means must therefore be employed to ascertain their sizes; and it cannot be said that any method has yet yielded very satisfactory results. Combining known distance with apparent magnitude, Maunder has calculated the absolute light-giving power of the following stars, that of the sun being unity, as shown in Table 16.4.

But these are far from indicating their real magnitudes; for amount of light is dependent upon intrinsic brightness of the radiating surface, as well as its extent. Among the giant stars are Arcturus, possibly a hundredfold the sun's diameter; also Vega and Capella, likewise much larger than the sun. Algol, too, must have a diameter exceeding a million miles, and its dark companion (page 391) is about the size of the sun—results reached by means of the spectroscope, which measures the rate of approach and recession of Algol when the invisible attendant

Table 16.4:

SIRIAN STARS		SOLAR STARS	
Procyon	25	Aldebaran	70
Altair	25	Pollux	170
Sirius	40	Polaris	190
Regulus	110	Capella	220
Vega	2050	Arcturus	6200

is in opposite parts of its orbit. The law of gravitation gives the mass of the star and size of its orbit, so that the length of the eclipse tells how large the dark, eclipsing body must be.

Types of Stellar Spectra.—Sir William Huggins in 1864 first detected lines indicating the vapor of hydrogen, calcium, iron, and sodium in the atmospheres of the brighter stars. Stellar spectra have been classified in a variety of ways, but the division into four types, proposed in 1865 by Secchi, has obtained the widest adoption. They are illustrated on the next page:—

Type I is chiefly characterized by the breadth and intensity of dark hydrogen lines; also a decided faintness or entire lack of metallic lines. Stars of this type are very abundant. They are blue or white; Sirius, Vega, Altair, and numerous other bright stars belong to this type, often called Sirian stars, a class embracing perhaps more than half of all the stars.

Type II is characterized by a multitude of fine dark, metallic lines, closely resembling the solar spectrum. They are yellowish like the sun; Capella and Arcturus (page 387) illustrate this type, often called the solar stars, which are rather less numerous than the Sirian stars. According to recent results of Kapteyn, absolute luminous power of first type stars exceeds that of second type stars seven-fold; and stars least remote from the sun are mostly of the second type.

Type III is characterized by many dark bands, well defined on the side toward the blue, and shading off toward the red end of the spectrum—a ‘colonnaded spectrum,’ as Miss Clerke very aptly terms it. Orange and reddish stars, and a majority of the variables, fall into this category; Alpha Herculis, Mira, and Antares are examples of this type. Type IV is characterized by dark bands, or flutings as they are often technically called, similar to those of the previous type, only reversed as to shading—well defined on the side toward the red, and fading out toward the blue. Stars of this type are few, perhaps 50 in number, faint, and nearly all blood-red in tint. Their atmospheres contain carbon.

Type V has been added to Secchi’s classification by Pickering, and is

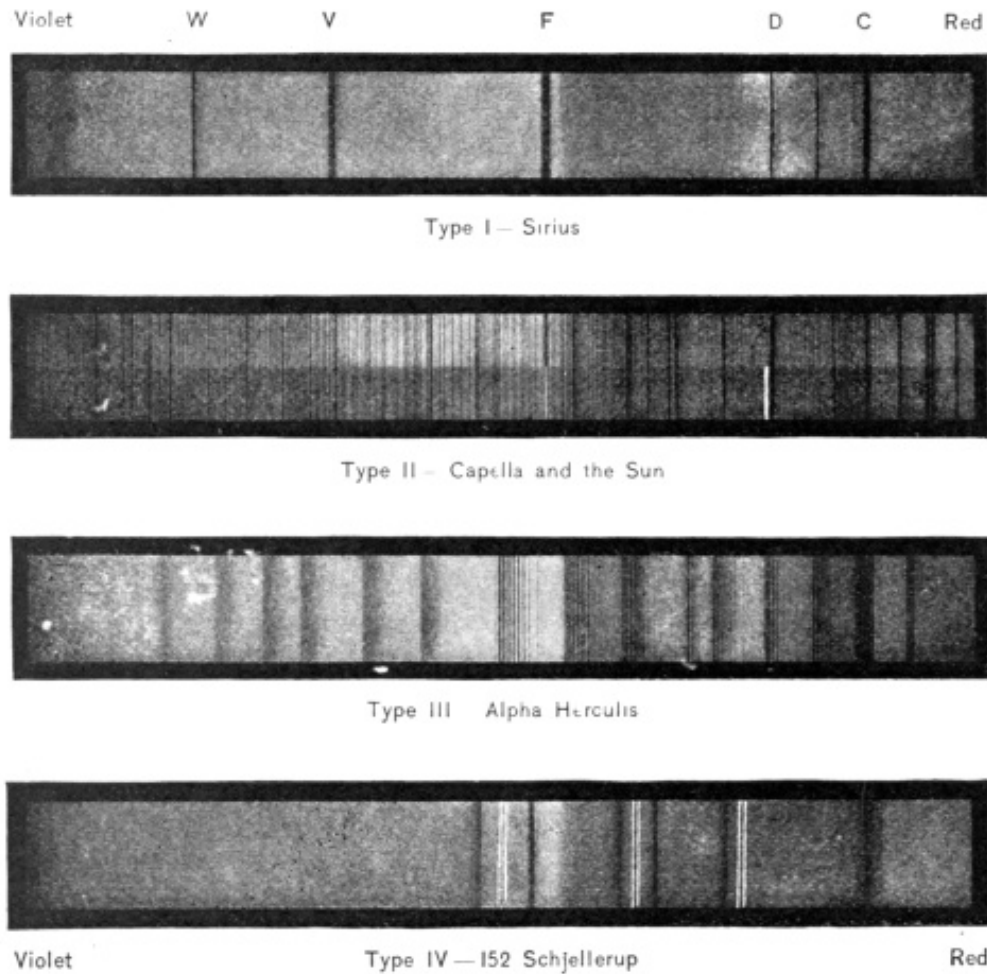

Secchi's Four Types of Stellar Spectra

characterized by bright lines. From two French astronomers who first investigated objects of this class, they are known as Wolf-Rayet stars. They are all near the middle of the Galaxy, and their number is about 70. They are a type of stellar objects quite apart by themselves, of which Campbell has made an especial study. Many objects called planetary nebulae yield a spectrum of this type.

A classification by Vogel combines Secchi's types III and IV into a single type. It is not yet determined whether these differences of spectra are due to different stages of development, or whether they indicate real differences of stellar constitution. Most likely they are due to a combination of these causes.

How a Star's Spectrum is commonly photographed.—The light of a fixed star comes to the earth from a definite point on the dome of the sky, so that

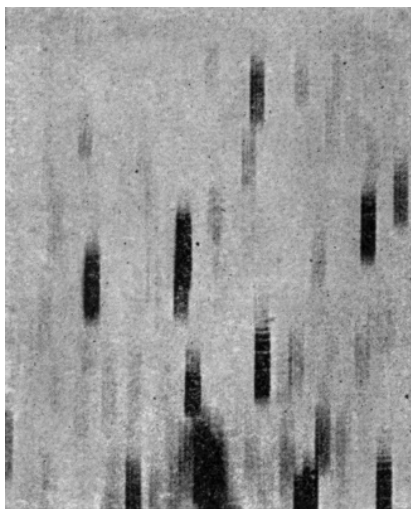

Spectra of Stars in Carina (Pickering)
(Exposure 2 h. 20 m.)

a stellar image, when produced by the object glass of a telescope, is also a point. Now suppose that a glass prism is attached to the telescope in front of its objective, as was first done in 1824, by Fraunhofer, and consider what takes place; the light of the star first passes through this prism, called the 'objective prism,' and then through the object glass, which brings the rays all to a focus. The star's image, however, is no longer a point, but spread out into a line, made up of many colors from red to violet. It is at this focus that the sensitive dry plate is inserted, and allowed to remain until the exposure is judged sufficient to produce the desired impression. Perhaps three hours are necessary; and during all this time the adjustment of the photographic telescope is so maintained that when the plate is developed, the spectra of all the stars will appear, not as lines, but as tiny rectangular patches, or bits of ribbon with light stripes across them. A 25th part of such a negative is pictured on this page, as obtained with the Bache telescope of the Boyden Observatory, by exposure in 1893 to the stars of the constellation Carina. On it were 1000 spectra sufficiently distinct for classification.

The Draper Catalogue.—With an identical instrument, similarly equipped with prisms, stellar spectrum photography has been vigorously conducted at Harvard College Observatory since 1886. The prisms are mounted with their edges east and west; and the clock motion is regulated according to the degree of dispersion employed, as well as the magnitude and color of the stars in the photographic field. Upon a single plate are often many hundred spectra; and in studying them, the great advantage of such close juxtaposition is at once apparent. For example, the spectra of about 50 stars in the Pleiades show at a glance practical identity of chemical composition. These researches, conducted under the superintendence of Edward C. Pickering, at the charges of a fund provided by Mrs. Draper as a memorial to her husband, gave to astronomers in 1890 the 'Draper Catalogue of stellar spectra,' including more than 10,000 stars down to the eighth magnitude. Nearly all the tedious and time-consuming labor of examining the plates was performed by Mrs. Fleming, Miss Maury, and others. This comprehensive system of registering spectra naturally paved the way for a more detailed classification of the stars than Secchi's; and with subsequent work

at the same observatory, has led to their division into about 20 groups. Also the peculiarities of spectra have led to the detection of numerous variable stars, and several new or temporary stars (page 389).

Stellar Spectra of High Dispersion.—Vega is the first star whose spectrum was successfully photographed by Henry Draper in 1872. Brightest stars afford sufficient light for the photography of their spectra, even after a high degree of dispersion by a train of several prisms, or by a diffraction grating. Multitudes of lines are thus recorded, especially in stars of the solar type. A part of the photographic spectrum of Arcturus is shown on the current page, almost a duplicate of the solar spectrum. In addition to the fine results obtained at Cambridge by Pickering, and at South Kensington by Sir Norman Lockyer, must be mentioned those of Vogel and Scheiner at Potsdam, near Berlin; and of Deslandres at Paris, who has lately detected in the spectrum of Altair a series of fine, bright, double lines, bisecting the dark hydrogen and other bands. He regards them as indication that this star is enveloped by a gaseous medium like that of the solar chromosphere.

Variable Stars.—A star whose brightness has been observed to change is called a variable star, or simply a ‘variable.’ About 3000 such objects are now recognized. This change may be either an increase or a decrease; and it may take place either regularly or irregularly. Other classes of variables rise and fall in different ways: some exhibiting several fluctuations of brightness in every complete period (like Beta Lyræ, a well known variable with a period of 12 d. 21 h. 47.4 m., whose spectrum presents a complexity of hydrogen lines and helium bands); some in simple periods only a few hours (the shortest at present known is ω Centauri 91, $6\frac{1}{5}$ h.); others changing slowly through several months. In general the last, which are usually reddish in tint, change as rapidly when near minimum as when near maximum, their light-curves being

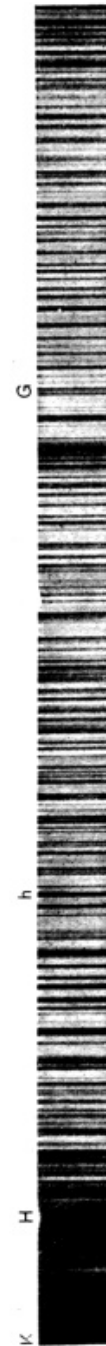

Part of the Photographic Spectrum of Arcturus (Sir Norman Lockyer)

like deep waves with sharp crests. Astronomers term these ‘Omicron Ceti variables,’ after the type star of this name, also known as Mira, or ‘the marvelous,’ whose variability has been known for three centuries. Their average period is about a year, and perhaps half of the recognized variables are of this type. Allied to them are the temporary stars described in a subsequent section. Of a type whose variation is the reverse of Mira are the ‘Algol variables,’ about 20 in number, whose light suddenly drops at regular intervals, as if some invisible body were temporarily to intervene.

Knowledge of the variable stars has been greatly advanced by the labors of Chandler and Sawyer, of Cambridge. Chandler’s catalogues contain about 500 classified variables. Such an object, previously without a name, is designated by letters R, S, T, U, and so on, in order of discovery in the especial constellation where found. The average range in recently discovered variables is less than one magnitude.

Distribution and Observation of Variables.—As to their distribution over the heavens, variable stars are most numerous in a zone inclined about 18° to the celestial equator, and split in two near where the cleft in the Galaxy occurs. Almost all the temporary stars are in this duplex region. A discovery of much significance was made by Bailey, in 1896, of an exceptional number of variables among the components of stellar clusters, more than 100 being found among the stars of a single cluster; and the mutations of magnitude are marked within a few hours. Variables are most interesting objects, and observations of great value may be made by amateurs. First the approximate times of greatest or least brightness must be ascertained; these are given each year in the ‘Companion’ to *The Observatory* (edited by Lewis and published at Greenwich), and in *Popular Astronomy* (issued monthly by Wilson at Northfield, Minnesota). In Table 16.5 are a few variables, easily found from star charts.

A small telescope or opera glass is a distinct help in observing a variable. When its brightness is changing, repeated comparison and careful record of its magnitude with that of other stars in the same field, will make it possible to ascertain the time of maximum or minimum. Such observations are of use to the professional investigator of periods of variable stars. Hagen’s new atlas is a great assistance.

Temporary Stars, or New Stars.—A variable star which, usually in a few weeks’ time, vastly increases in brightness, and then slowly wanes and disappears entirely, or nearly so, is called a temporary star. Accounts of several such are contained in ancient historical records. In the Chinese annals is an allusion to such an outburst in Scorpio, B.C. 134; it was observed by Hipparchus, and led to his construction of the first known catalogue of stars, made with reference to the detection of similar phenomena in the future. Tycho Brahe carefully observed a remarkable object of this class near

Table 16.5: VARIABLE STARS

STAR'S NAME	POSITION (1900.0)				VARIATION		TYPE OF VARIABLE
	R. A.		DECL.		PERIOD	RANGE	
	h.	m.	°	'	Days	Magnitude	
Omicron Ceti . .	2	14	S.	3 26	331	1.7 to 9.5	Mira.
Beta Persei	3	2	N.	40 34	$2\frac{7}{8}$	2.3 to 3.5	Algol.
Zeta Geminorum	6	58	N.	20 43	$10\frac{1}{7}$	3.7 to 4.5	
R Leonis	9	42	N.	11 54	313	5.2 to 10	
Delta Libræ	14	56	S.	8 7	$2\frac{1}{3}$	5 to 6.2	Algol.
Alpha Herculis .	17	10	N.	14 30	$90\pm$	3.1 to 3.9	Irregular.
X Sagittarii	17	41	S.	27 48	7	4 to 6	
Beta Lyræ	18	46	N.	33 15	12.9	3.4 to 4.5	
Delta Cephei . . .	22	25	N.	57 54	$5\frac{1}{3}$	3.7 to 4.9	

Cassiopeia, which, in the latter part of 1572, surpassed the brightness of Jupiter, was for a while visible in broad daylight, and, in a year and a half, had completely disappeared. In 1604–5 a new star of equal brightness was seen by Kepler in Ophiuchus; it also disappeared. None were recorded in the 18th century. Similar objects appeared and passed through like stages near our own day in—

- 1866 in Corona Borealis;
- 1876 in Cygnus;
- 1885 in the Great Nebula in Andromeda;
- 1891–92 in Auriga;
- 1901 in Perseus.

Such a star is often called *Nova*, with the genitive of its constellation added, as *Nova Cygni*. Temporary stars remain unchanged in apparent position during their great fluctuations of brightness, and no new star has been found to have a measurable parallax. Probably *Nova Andromedæ* was connected with the nebula in which it appeared. The new stars of 1866 and 1892, after dropping to a low telescopic magnitude, had a secondary rise in brightness, though not to their original magnitude, after which they faded to their present condition as very faint telescopic objects. *Nova Aurigæ* has become a faint nebulous star. Thorough search by Mrs. Fleming of the photographic charts and spectrum plates of the Harvard College Observatory, obtained

in both hemispheres, has led to the detection of many new stars that would otherwise have escaped observation. Among them are Nova Normæ (1893) and Nova Aquilæ (1899).

The New Star in Perseus.—The most brilliant temporary star of modern times appeared in the constellation Perseus in February, 1901. At maximum on the 23d, it outshone Capella. Its waning light exhibited many unusual fluctuations of brightness. In August, 1901, a nebula surrounding it was discovered; and a month later, certain wisps of this nebulosity appeared to have moved bodily, at a speed seventy-fold greater than ever previously observed in the stellar universe. This unprecedented appearance is best explained by the meteoritic hypothesis of Sir Norman Lockyer, according to which a vast nebulous region has been invaded, not by one, but by many meteor swarms, under conditions such that the effects of collision vary greatly in intensity. The result of the most violent collision was the new star Nova Persei itself, and the least violent occurred subsequently in other parts of the disturbed nebula, almost immeasurably removed. Thus there is no necessity of supposing actual motion through space at velocities heretofore unobserved and inconceivably high.

Spectra of New Stars.—The spectroscope has proved itself a powerful adjunct in the observation of temporary stars. First employed on the Nova of 1866, it demonstrated the presence of incandescent hydrogen. Nova Cygni, ten years later, gave a similar spectrum, added to which were the lines of helium, long known in the sun, but only in 1895 identified as a terrestrial element. Nova Andromedæ (1885) to most observers presented a continuous spectrum; but Nova Aurigæ (1892) gave a distinctly double and singularly complex spectrum. Many pairs of lines indicated clearly a community of origin as to substance, and accurate measurement showed a large displacement which indicated a relative velocity of nearly 900 kilometers, or more than 500 miles per second; and this type of spectrum remained characteristic for more than a month. For each bright hydrogen line displaced toward the red there was a dark companion line or band, about equally displaced toward the violet. It was as if the strange light were due to a solid globe moving swiftly away from us, and plunging into an irregular nebulous mass swiftly approaching us. Tests for parallax placed Nova Aurigæ at the distance of the Galaxy, so that this marvelous celestial display must actually have occurred in space as remotely as the beginning of the 19th century. Nova Normæ was characterized by a spectrum almost identical with that of Nova Aurigæ, as also Nova Persei, with calcium, hydrogen, and helium lines.

Irregular Variables.—These objects are not numerous, but some of them are very remarkable; for example, Eta Argûs, an erratic variable in the southern hemisphere (shown in the midst of the nebulosity on page 373). Halley, who visited Saint Helena in 1677, recorded its magnitude as the fourth. Between 1822 and 1836 it fluctuated between the first and second magnitudes; but in 1838 the light became tripled, rivaling all the stars except Sirius and Canopus.

In 1843 it was even brighter, but since then it has declined more or less steadily, reaching a minimum of the $7\frac{1}{2}$ magnitude in 1886. Probably it has no regular period, although one of a half century has been suggested. Later the brightness of Eta Argûs exhibited a slight increase. A few other stars vary in this irregular manner, though their fluctuations are confined to a much narrower range.

Variables of the Algol Type.—Algol is the name of the star Beta Persei, the best known object of this class. As a rule, the periods of this type of variables are short, and they remain at maximum brightness during nearly the whole. Then almost suddenly they drop within a few hours to minimum light, remain there but a fraction of an hour, and almost as rapidly return to full brightness again. The spectra of all Algol variables are of the first type.

Figure 16.12 represents the light-curves (between maximum and minimum) of four stars of this type, as determined by E. C. Pickering at the Harvard College Observatory. The star W Delphini, although telescopic, is the most pronounced object of this type so far discovered. It remains at full brightness rather more than four days; then from the 9.3 magnitude (upper left-hand corner of the diagram) it drops in seven hours to the 12.0 magnitude, becoming so faint as to be invisible in a four-inch telescope. Algol, in $4\frac{1}{4}$ hours, drops a little more than 1.0 magnitude, and returns to its full brightness in $5\frac{1}{4}$ hours, as the curve shows. Its period, or interval from one minimum to the next, is very accurately known; at present it is 2 d. 20 h. 48 m. 55.4 s., and is very gradually lessening. At full brightness Algol is of the 2.2 magnitude, and is therefore a conspicuous star. It remains at minimum only about 15 minutes. Algol is best observed from early autumn to the middle of spring. Belonging to a type regarded by some as new, though at first classified with Algol stars, are a few such rapid variables as S Antliae which was discovered by Paul in 1888. These compound stars would seem to constitute a binary system whose members swing round each other almost in contact (page 407).

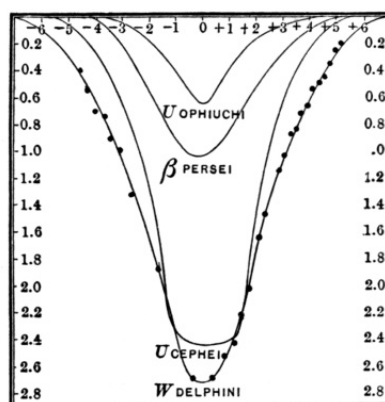

Light-Curves near Minimum of Four Algol Variables (Pickering)

Causes of Variability.—No general explanation seems possible covering the variety in mutations of brightness of all classes of variables. Those of the Algol type are readily accounted for by the theory of a dark eclipsing body, smaller than the primary, and traveling round it in an orbit lying

nearly edgewise to us. The illustration shows this: in the upper figure the system appears as we look at it; in the lower, as it would seem if we could

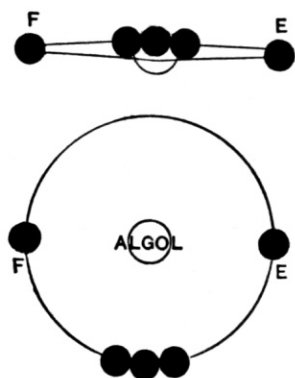

Orbit of Algol's Dark Companion

look perpendicularly upon it. Gravitation of a massive dark companion would, by its movement round Algol, displace it alternately toward and from the earth, when in the positions *E* and *F*; because the two bodies must revolve round their common center of gravity. Just such a motion of Algol in the line of sight has been detected with the spectroscope, proving that the star alternately recedes from and advances toward us at the rate of 26 miles per second, in a period synchronous with that of its variability.

For variables of other types, a comprehensive explanation is found in vast areas of spots, similar to spots on the sun, taken in connection with the star's rotation on its axis and a periodicity of the spots themselves. The new stars are more likely due to tremendous outbursts of glowing hydrogen; perhaps in some cases to vaporization of dark bodies caused by their brushing past each other, or to a faint star's actual plunging through a gaseous region of space. Sir Norman Lockyer's theory for variables of the Omicron Ceti class is made clear by the illustration: variable stars are still in the condition of meteoric swarms; and the orbital revolution of lesser swarms around larger aggregations must produce multitudes of collisions, periodically raising hosts of meteoric particles to a state of incandescence.

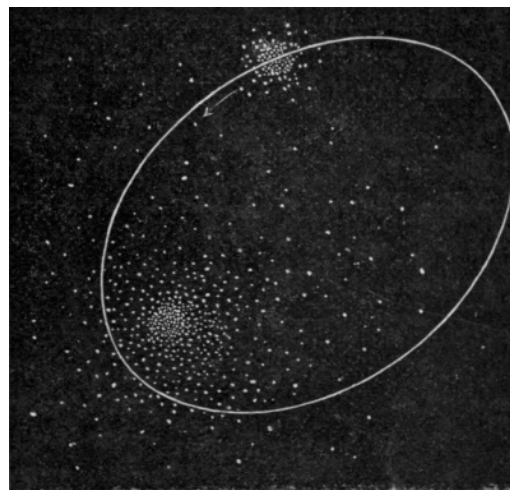

Sir Norman Lockyer's Meteoritic Theory of Variables

Double Stars.—Many stars which to the unassisted eye look simply as one, are separated by the telescope into more than one. According to the number, these are called double, triple, quadruple, or multiple stars. When the components of a pair

appear to be associated together in space, it is catalogued as a double star. A few stars, however, are only apparently double, having no actual relation to one another in space, and only seeming in proximity because they happen to be nearly in the line of sight from the earth. They are remote from each other, as well as from the solar system. Such pairs of stars are called *optical doubles*.

Although a few double stars were known earlier, history of the discovery and measurement of these objects may be said to have begun with Sir William Herschel in 1779. The Struves, father and son, and Baron Dembowski, among others, have prosecuted these researches vigorously. More than 10,000 double stars are now known, and discoveries have been rapidly made in recent years, particularly by Burnham of Chicago. The next illustration shows a dozen of the easier doubles, within reach of small telescopes. Instruments of greater diameter than six inches are necessary to divide the components of a double star whose apparent distance from one another is less than $0''.8$. Bond and Gould were pioneers in the application of photography to observation of the wider ‘doubles’; but here the assistance of this new method is not as important as in other departments of astronomy. Among other European observers of double stars are Bigourdan of Paris and Glasenapp of Saint Petersburg; and in America A. Hall, Comstock, and Leavenworth.

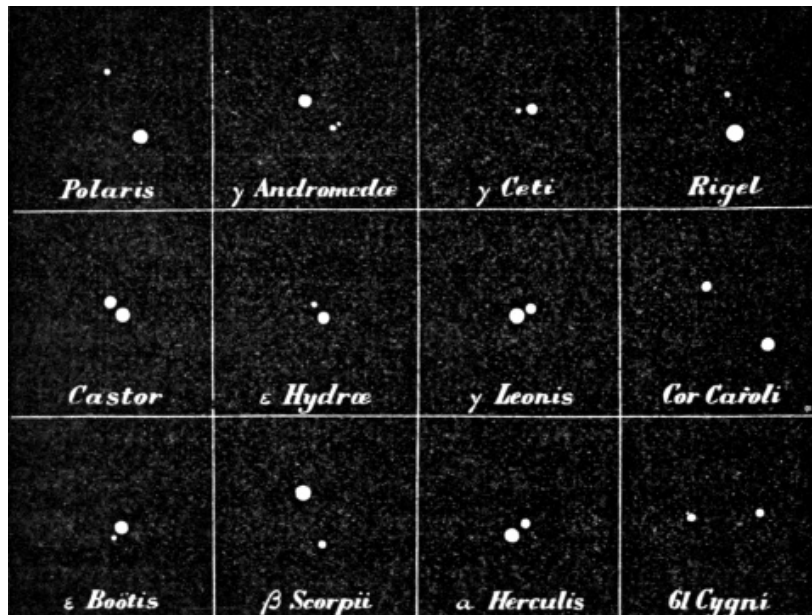

Twelve Typical Double Stars

Binary Stars.—Careful and protracted observations are necessary to determine the class to which any pair of stars belongs. If the components of a ‘double’ are found to revolve in a closed or elliptic orbit, they are called a *binary star*. It is assumed, and doubtless rightly, that this motion depends upon gravitation.

About 200 binaries are now known, and the orbits of perhaps 50 of them are well ascertained. In his *Researches on the Evolution of the Stellar Systems* (1896), See has presented a summary of present knowledge of these bodies. According to Miss Everett’s investigation, the planes of their orbits sustain no definite relation to any fundamental plane of the heavens. The star known as β 883 (star No. 883 discovered by Burnham) is the shortest known binary, its period being $5\frac{1}{2}$ years; the longest is Zeta Aquarii, not less than 1500 years. Several binary stars are recognized, one component of which is dark. These can be discovered only by the effect which the attraction of the dark star produces in changing the position of the bright one. The giant Sirius is a star of this kind, having a faint attendant only bright enough to be detected with large telescopes, and known as the companion of Sirius. Its orbit as determined by Burnham from observations 1862–96 is shown adjacent. Before actual discovery (by A. G. Clark in 1862), not only its existence but its true position had been predicted by Auwers. The companion’s period is 49 years; and its motion, and distance both from Sirius and from the solar system, show that the mass of the companion equals that of the sun, while that of the Dog Star itself exceeds that of the sun $2\frac{1}{5}$ times.

But the best known binary system is the one first discovered (by Richaud in 1689), Alpha Centauri, also the nearest of all the fixed stars. Its components are of the first and second magnitude. The period of the stars’ revolution is 81 years, the masses of the two components are very nearly equal, and their combined mass is twice that of the sun. The stars of a binary system are said to be in *periastron* when nearest to one another in space; and in *apastron* when farthest. At periastron the components of Alpha Centauri are about as far apart as Saturn is from the sun; in apastron their distance from each other greatly exceeds that of Neptune from us.

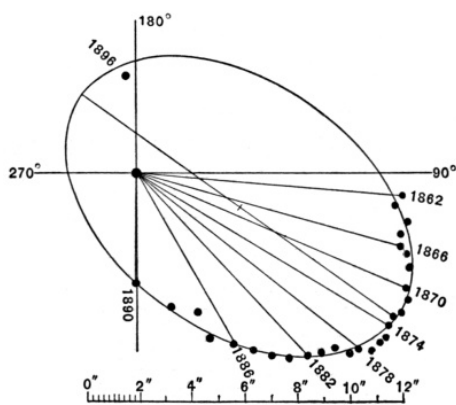

Orbit of Sirius (Burnham)

Eccentricities and Masses of Binary Stars.—The orbits of binary

stars are remarkable for great eccentricity; also for the large mass-ratios of their components, always comparable, and in some cases nearly equal. In these respects they differ greatly from the bodies of the planetary system, the orbits in which are nearly circular, and none of the planets have more than a small fraction of the sun's mass. See explains the exceptionally high eccentricity of binary orbits, according to the principles of tidal evolution, from orbits which were nearly circular in the beginning. Originally the system was a single rotating nebulous mass, which became modified into a dumb-bell figure as a result of its own contraction. The average eccentricity of the best known binaries is 0.48, while that of the planets and satellites in our system is less than 0.04, or only $\frac{1}{12}$ as great; and this extraordinary relation may be accepted as the expression of a fundamental law of nature. Recalling the principles by which the mass of a planet is compared with that of the sun, it is evident that a like method will give the mass of a binary system, also in terms of the sun. First we must measure the major axis of the orbit, and observe the period of revolution; also it is necessary to assume that the Newtonian law of gravitation governs their motion. Then:—

$$\frac{\left[\begin{array}{c} \text{Moon's distance} \\ \text{from earth} \end{array} \right]^3}{\left[\begin{array}{c} \text{Moon's sidereal} \\ \text{period} \end{array} \right]^2 \times \left[\begin{array}{c} \text{Earth's mass} \\ + \text{moon's} \end{array} \right]} = \frac{\left[\begin{array}{c} \text{Distance between components} \\ \text{of Alpha Centauri} \end{array} \right]^3}{\left[\begin{array}{c} \text{Period of their} \\ \text{revolution} \end{array} \right]^2 \times \left[\begin{array}{c} \text{Sum of masses} \\ \text{of components} \end{array} \right]}$$

Masses of the few binary systems ascertained in this manner are about twofold or threefold that of the sun.

Binaries discovered by the Spectroscope.—It was Bessel who first wrote of the ‘astronomy of the invisible,’ and his prediction has been marvelously fulfilled by the recent discovery of spectroscopic binaries. They are binaries whose components are so near each other that the telescope cannot divide them, and whose spectra therefore overlies. As the orbits of binary systems stand at all possible angles in space, a few will appear almost edge on. Let the two components be in conjunction, as referred to the solar system; clearly their spectra will be identical. But when they reach quadrature, one will be receding from the earth and the other coming toward it. A given line in the compound spectrum, then, will appear double, on account of displacement due to motion of the components in opposite directions. Measure the displacement, and observe the period of its recurrence. This gives the velocity of the components relatively to each other, the dimensions of their orbit, and their mass in terms of the sun, always assuming that the same law of gravitation is regnant among the stars.

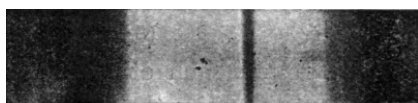

1889, Dec. 30 d. 17.6 h., G.M.T.
(single)

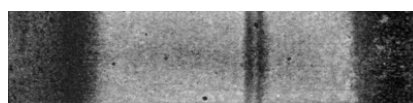

1889, Dec. 31 d. 11.5 h., G.M.T.
(double)

Spectra of β Aurigæ (Pickering)

The binaries so far discovered by this method have relatively short periods; the shortest known is μ^1 Scorpii, only 35 hours. Beta Aurigæ is a remarkable star of this class, the doubling of its lines taking place on alternate nights, giving a period of four days; and the combined mass of both stars is more than twice that of the sun. The region of its spectrum is here shown, with lines both double and single. New stars of this type are continually coming to light; but if the orbits lie perpendicular to the line of sight, the duplicity is not discoverable in this manner. Nearly one tenth of all the stars so far examined reveal orbital motion. Possibly the star unattended by dark companions may, Campbell thinks, prove to be the rare exception. Relative velocities of the components are in some cases as large as 300 or even 400 miles per second. Among pronounced spectroscopic binaries are Capella, Castor, Mizar, Polaris, and Spica. Campbell's first catalogue of these bodies (1905) contains nearly 150, distributed all over the sky, and there are numerous new discoveries each year. Other discoverers in this field are B elopolsky, Frost, Vogel, and Wright.

Multiple Stars.—Numerous stars have more than two components in the same field of view. These are generally called *multiple stars*, though the terms *triple star* for three components, *quadruple* for four, and so on, are often used. In isolated instances a star may be optically multiple; that is, the components appear to be associated together, from the fact that they are in or near the line of sight, while in reality they are at vastly different distances from the sun, and are in no sense related to each other. Nearly all multiple stars are physically multiple; that is, connected together in a real system. Such a system is the star Epsilon Lyræ, the well-known fourth-magnitude star, near Vega. A keen eye, even without optical assistance, will split it into a double. A small telescope will divide each of the two components into a pair, forming a beautiful quadruple system; while large telescopes show at least three other faint stars, one of them very difficult, between the pairs. Not only do the two stars of each pair revolve round each other, in periods of several hundred years, but the pairs themselves have a grander orbital motion round each other in a vast period not yet determined. A multiple star having more than seven or eight components

would be classed as a *star cluster*.

Stellar Clusters.—Seeming aggregations of stars in the sky are called *stellar clusters*, or simply *clusters*. Broadly speaking, they are embraced in two classes: The loose clusters, so called because the stars are not very thickly scattered, of which the Pleiades are a very conspicuous type; and the close clusters, in which the stars appear to be thickly aggregated. The Pleiades contain six stars visible to the ordinary naked eye, though seven, nine, and even as many as thirteen stars have in rare instances been seen in this group without a telescope. A medium glass shows about 100 stars, and a photographic plate exposed an hour displays more than 2000 stars in and close to the Pleiades. An exposure of six hours shows 4000 stars. The longer the exposure, the more stars appear on the plate. By an exposure of 17 h. 30 m., continued on nine nights, and covering a region of four square degrees, nearly 7000 stars are counted in the Pleiades. Recent counts make them fewer in the immediate regions of the bright stars than in adjacent portions of the sky of equal area; and very much fewer than in many parts of the Milky Way. Also by photography Barnard has discovered extensive nebulosities surrounding the Pleiades, which the glare of the larger stars makes difficult to see with a telescope. They have crudely the shape of a horseshoe.

One type of close clusters is known as the *globular cluster*, in which the stars are compacted together as if in a seemingly circular area, or in space a nearly globular mass. The adjacent picture is an excellent illustration of this type. The more nearly spherical a cluster is, the older it is thought to be; for the individual components of clusters are no doubt subject to the laws of central attraction, and the more perfect approach to a spherical figure would indicate that the action of central forces had been longer continued. Thus it is possible to infer the maturity of a cluster from the relative disposition of its component numbers. One of the finest objects in the sky is the double cluster, excellently reproduced in the photograph on the following page. It forms part of the Milky Way in Perseus, and each component approaches the globular form. The clusters are made up of stars of all sizes, and are without doubt at stellar distances from us, though no parallax of a cluster has yet been

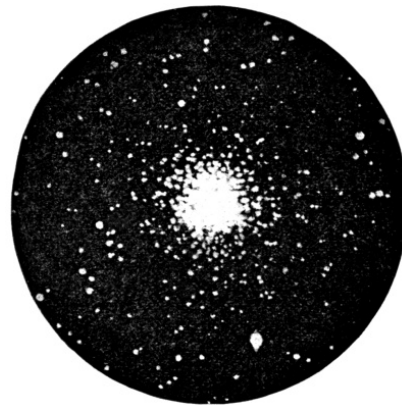

Globular Cluster 15 Pegasi
(Roberts)

measured. In all, about 200 clusters and nebulae have been photographed, so that a half century hence it may be possible to ascertain what changes are taking place.

The Galaxy, or Milky Way.—Lying diagonally across the dome of the sky, at varying angles and elevations in different seasons of the year, may be seen on clear, moonless nights an irregular belt or zone of hazy light of uneven brightness, about three times the breadth of the moon, and

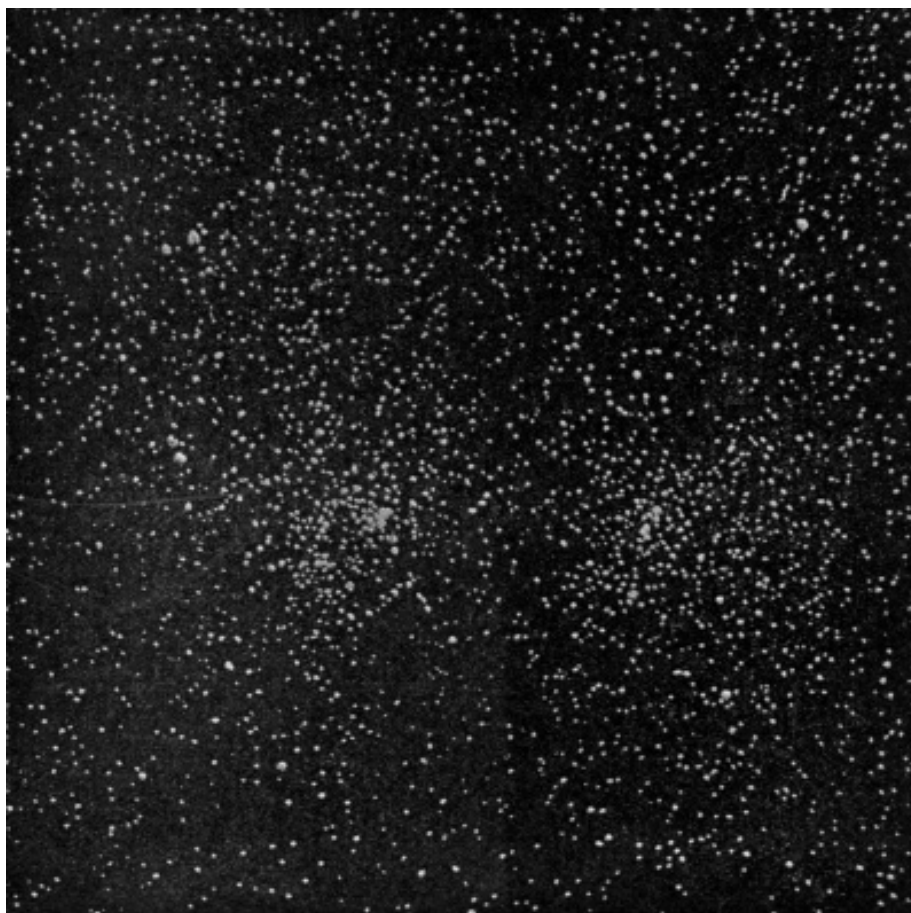

The Double Cluster in Perseus (photographed by Roberts)

stretching from horizon to horizon. This is part of the Galaxy, or Milky Way. It is really a ring of light, reaching entirely round the celestial sphere, roughly in a great circle; and usually about half of it will be above the horizon and half below. It intersects the ecliptic near the solstices, at an angle of about 60° . Early in September evenings it nearly coincides with a vertical circle lying northeast and southwest. The Galaxy is fixed in relation

to the stars, and part of it lies so near the south pole of the heavens that it can never be seen in our northern latitudes. From Cygnus to Scorpio it is a divided belt, or double stream. Even a small telescope shows at once that the Milky Way is composed of millions of faint stars, nearly every one of them individually too faint for naked-eye vision, but whose vast numbers give us collectively the gauzy impression of the Galaxy. On page 13 is an excellent reproduction from one of the finest of Barnard's photographs of the Milky Way, and equally striking photographs have been obtained by Wolf, and of the Southern Milky Way by Russell. All these stars are suns, and probably comparable in size and constitution with the sun himself.

They are not evenly scattered, but in many regions are aggregated into close clusters of stars; for example, the double cluster in the sword hilt of Perseus, shown opposite. It is readily visible to the naked eye on clear, moonless nights in the position shown in diagram on page 59. According to Easton, the galactic system accessible to our observation has but little depth in proportion to its diameter. Study of the photographs has led Maunder to direct attention to 'dark lanes' in the Milky Way, marking regions of real barrenness of stellar material, and perhaps indicant of galactic condensation progressing toward an ultimate globular cluster.

Distribution of the Stars.—As to their apparent distribution over the face of the sky, lack of uniformity is evident. The fact of their recognized division into constellations, even from the earliest ages, is proof of this. Clusters and starless vacuities are well known. Frequently there are found streams of stars, especially by exploration with the telescope. One general law is known to govern the apparent distribution in the heavens: at both poles of the Milky Way, the stars are scattered most sparsely; and the number in a unit of surface of the stellar sphere increases on all sides uniformly toward the plane of the Milky Way itself. This important discovery was made by Sir William Herschel, through a laborious process of actually counting the stars, technically called 'star gauges.' In Coma Berenices, for example, near the north pole of the Milky Way, are perhaps five stars in a given area; half way to the Galaxy the number has doubled; and in the Milky Way itself the average number is found to exceed 120, thus increasing more rapidly as this basal plane of the sidereal universe is approached. Kapteyn, a recent investigator of this supreme problem, likens the general shape of the stellar universe to that of the great nebula in Andromeda (opposite); the disk-shaped nucleus representing the cluster to which the sun belongs, and its exterior rings the flattened layers of stars surrounded by the zone of the Galaxy.

The Nebulæ.—A nebula is a celestial object, often of irregular form

and brightness, appearing like a mass of luminous fog. In all, over 10,000 are now known, and their positions among the stars determined. They differ

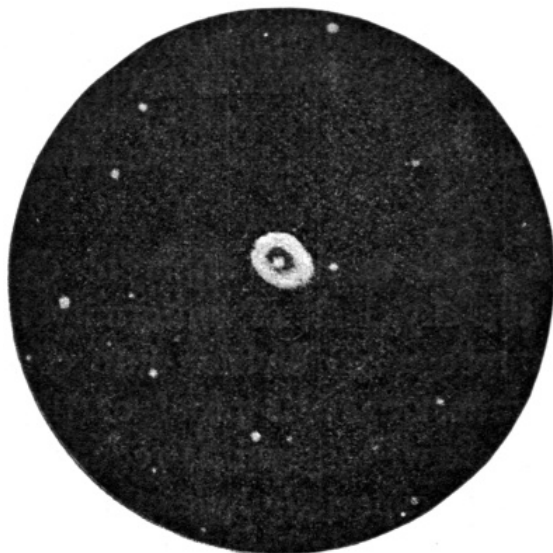

Ring Nebula in Lyra (Roberts)

greatly in brightness, form, and apparent size. Many of them are shown by the spectroscope to be glowing, incandescent gases, in large part hydrogen. These are greenish in tint; but a few whitish ones are resolvable; that is, composed of masses of separate stars too faint to be seen individually. The nebulae appear like the residue of the materials of original chaos out of which the sun, his planets, and the stars have through many millions of years come into being. A few of them are variable in brightness.

Classification of the Nebulae.—It is usual to divide the nebulae into five classes, based on their various forms: (1) annular nebulae, (2) spiral nebulae, (3) planetary nebulae, (4) nebulous stars, (5) irregular nebulae, for the most part large. Perrine estimates that the entire sky contains more than 500,000 very faint nebulae, within photographic reach of the great reflecting telescopes, which are better suited to this work than refractors. Especially fine photographs of nebulae have been made by Ritchey, Wolf, and Keeler, and Keeler concludes that spiral filaments seem to be the prevailing type of nebular structure. A very extensive catalogue of nebulae is by Dreyer.

By prolonged exposures fine photographs of the fainter nebulae have been obtained by von Gothard and others. A famous nebula of the irregular order surrounds the star Eta Argus (page 373). In recent years it has been frequently photographed by Gill and Russell with exposures of many hours' duration, and changes in its brightness are plainly indicated.

Remarkable Annular and Elliptic Nebulae.—A fine object of this class was discovered by Gale in 1894 in the southern constellation Grus; but the best-known annular nebula is in the constellation Lyra. A very faint object in small telescopes, the great ones reveal many stars within its interior spaces. The illustration on p. 400 is from a photograph of the nebula, but it does not show the complexity and irregularity of structure which some of the large telescopes indi-



The Great Nebula in Andromeda (Roberts)

cate. The star near its center is thought to be variable. Among elliptic nebulae, the signal object is the 'great nebula in Andromeda.' So bright is it that the unaided eye will recognize it, near Eta Andromedæ. Its vast size, too, as seen in the telescope, is remarkable—about seven times the breadth of the moon, and its width more than half as great. The illustration shows its striking structure, first clearly revealed by Roberts's splendid photographs in 1888. Apparently it

is composed of a number of partially distinct rings, with knots of condensing nebulosity, as if companion stars in the making. Its spectrum shows that it is not gaseous, still no telescope has yet proved competent to resolve it.

Spiral and Planetary Nebulæ.—The great reflecting telescope of Lord Rosse first brought to light the wonderful spiral nebulæ, the most



Spiral Nebula in Canes Venatici (Roberts)

conspicuous example of which is found in Canes Venatici. Its structure is such that photography has a vast advantage in depicting it, as the adjacent illustration reveals. The convolutions of the spiral are filled with many star-like condensations, themselves surrounded by nebulosity. The spectroscope indicates its stellar character, though, like the Andromeda nebula, it is yet unresolved, except in parts. Planetary nebulæ have this name because they exhibit a disk with pretty definite outlines,

round or nearly so, like the large planets, though very much fainter. They are nearly all gaseous in composition. Nebulous stars are stars completely enveloped as if in hazy, nebulous fog. They are mostly telescopic objects, and very regular in form, some with nebulosity well defined, others less so. One has luminous rings surrounding it.

Spectra of the Nebulæ.—Sir William Huggins, who in 1864 first applied the spectroscope to nebulæ, discovered bright lines in their spectra, indicating a community of chemical composition, due to glowing gas, in large part hydrogen. Helium has recently been added; but other lines are due to substances not yet recognized as terrestrial elements. The annular, planetary, and mostly the irregular nebulæ give the gaseous spectrum; and exceedingly high temperatures are indicated, or else a state of strong electric excitement. Both temperature and pressure appear to increase toward the nucleus of the nebula. Many nebulæ fail to yield bright lines; showing rather a continuous spectrum, prominently the

great nebula of Andromeda. Lack of lines may be interpreted as due to gases under extreme pressure, or to aggregations of stellar bodies. Another object of this character is the great spiral nebula in Canes Venatici, well depicted in the photograph by Roberts (opposite); but no telescope has yet been able to resolve either of these objects into discrete stars. The application of photography has revealed about 40 lines in the spectra of nebulae; and Keeler and Campbell have shown, in the case of the Orion nebula, that nearly every line in its spectrum is the counterpart of a prominent dark line in the spectra of the brighter stars of the same constellation.

The Great Nebula in Orion.—Just below the eastern end of Orion's belt is this greatest of all nebulae. So characteristically bright is this well-known object that it is readily distinguished without a telescope. It was the first nebula ever photographed—by Henry Draper in 1880. The spreading expanse of its nebulosity completely envelops the multiple star Theta Orionis, often called the 'trapezium' (not well shown in the photograph because the blur of the nebula overlaps it). In small instruments a very obvious feature is the wide opening at one side, or break in the general light, sometimes called the 'Fish's mouth.' A curdling or flocculent structure is excellently shown in the best photographs, and a greenish tinge has been recognized in

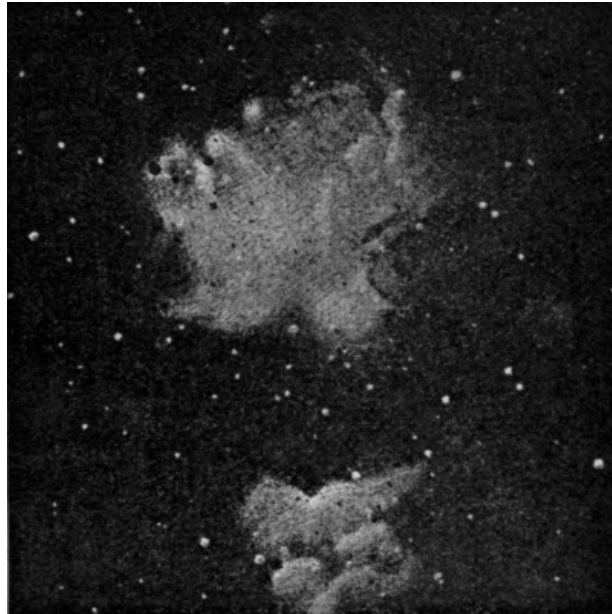

The Great Nebula in Orion (Bond)

its light. Extensive wisps of nebulosity reach out in many directions, involving other stars. W. H. Pickering's plates indicate an approach to the spiral figure in these outlying filaments, and Roberts's photographs show vortical areas within the nebula. Its spectrum reveals incandescent hydrogen and helium; also other substances not yet recognized among terrestrial elements. The nebula is as remote as the stars are; and, according to Keeler's observations, its distance from the sun is increasing at the rate of 11 miles every second. Also they prove an intimacy of relation between the nebula

and neighboring stars. There is no conclusive evidence of change of form in any part of the nebula, although Holden has investigated this question fully. The light of the nebula is far from homogeneous, being different in its spectral composition in different regions.

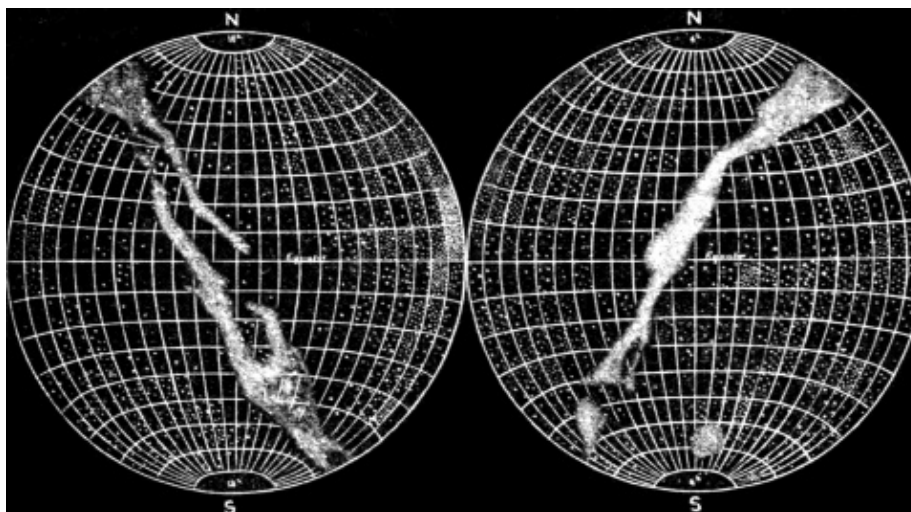

Path of Milky Way and Distribution of Nebulæ (according to Proctor)

Distribution of the Nebulæ.—It may be said that the nebulæ are distributed over the sky in just the opposite manner from the stars; for their number has a definite relation to the Milky Way. Reference to the preceding figure will show this at a glance. The small dots represent nebulæ, not stars; and it is at once evident that they are more strongly clustered the greater their angular distance from the Milky Way. The physical reason underlying this fact is not known. Neither is the distance of any nebula known. So that the distribution of the nebulæ throughout space can only be surmised. Measurement of the distance of a few nebulæ has been attempted, with the disappointing outcome that their parallax is exceedingly small, and probably beyond our power ever to ascertain. They are, therefore, at distances from our solar system estimable in light years, like those of the stars. Keeler's spectroscopic observations prove that the nebulæ are moving in space at velocities comparable with those of the stars; the bright nebula in Draco, for example, is coming toward the earth at the rate of 40 miles every second. None of the nebulæ, however, have yet been discovered to partake of proper motion.

The Cosmogony.—Cosmogony is the science of the development of the material universe. It has nothing to do with the origins of matter, and is concerned only with its laws and properties, and the transformations

resulting from them. The ancient philosophers avoided the question of the origin of matter by asserting that the universe always had its present form from eternity; many minds are still satisfied with a literal interpretation of the Old Testament account of the creation, that the Almighty Power, out of nothing, built the universe in six days, substantially as observed in our own age; according to the accepted cosmogony, the universe was in the beginning a widely diffused chaos, 'without form and void,' according to the Scriptures. Out of it has been evolved, by the long-continued action of fixed natural laws, the present orderly system of the universe.

The Universe is exceedingly Old.—In outline, the accepted cosmogony is this: Once in the inconceivably remote past, many hundreds of millions of years ago, all the matter now composing earth, sun, planets, and stars, was scattered very thinly through the untold vastness of the celestial spaces. The universe did not then exist, except potentially. Then, as now, every particle of matter attracted every other particle, according to the Newtonian law. Gradually centers of attraction formed, and these centers pulled in toward themselves other particles. As a result of the inward falling of matter toward these centers, the collision of its particles, and their friction upon each other, the material masses grew hotter and hotter. Nebulæ seeming to fill the entire heavens were formed—luminous fire mist, like the filmy objects still seen in the sky, though vaster, and exceedingly numerous.

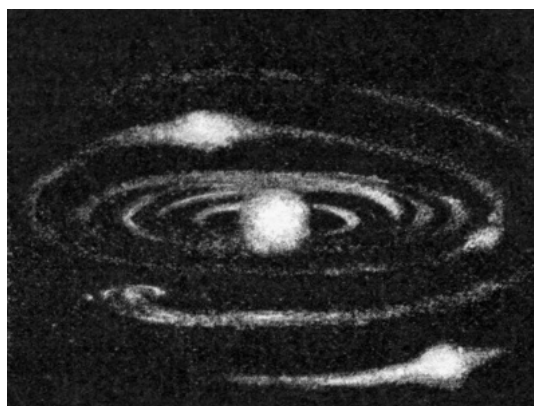

Ideal Genesis of Planetary System (Compare with actual nebula on page 401)

Stars and Suns from Nebulous Fire Mist.—Countless ages elapsed; the process went on, swifter in some regions of space than in others. Millions upon millions of nebular nuclei began to form; condensation progressed; because the particles could not fall directly toward their centers of attraction, vast nebular whirlpools were set in motion; axial rotation began; and temperature rose inconceivably high at centers where condensation was greatest. The sun was one of these centers; earth and all the other planets had not yet a separate existence, but the materials now composing them were diffused through the great solar nebula. Every star, whether lucid or telescopic, was such a center, or became one in the gradual evolution and

process of world building.

Planets from Nebulous Stars.—As contraction and condensation went on, the whirling became swifter, because gravitation brought the particles nearer to the axis round which they turned, and there was no loss of rotational moment of momentum. Centrifugal force gave the whole rotating mass the figure, first of an orange, then of a vast thickened disk, shaped like a watch. Eventually the masses composing its rim could no longer whirl round as swiftly as the more compact central mass; so a separation took place, the outlying nebulous regions being left or sloughed off as a ring, while all the central portion kept on shrinking inward from it. As shown opposite, the mass of the ring would rarely be distributed uniformly; but being lumpy, the more massive portions would in time draw in the less massive ones, and the ring would thus become a planet in embryo; and its time of revolution round the sun would be that of the parent ring. If still nebulous, the planet would itself go through the stages of the solar nebula, and slough off rings to gather into moons or satellites. Meanwhile the parent nebula went on contracting, and leaving other rings, which in the lapse of ages developed into inner planets, and their rings as a rule into satellites.

Early History of the Nebular Hypothesis.—Such in bare outline is the nebular hypothesis. Note that it is merely a highly plausible theory; it has never been absolutely demonstrated, and probably never can be. To its development many great minds have contributed. The Englishman Thomas Wright, the Swede Emanuel Swedenborg, and the German Immanuel Kant, all, independently and during the 18th century, appear to have originated the hypothesis under slightly variant forms. Of these, Kant's theory was the most philosophic; but his greater renown as a mental philosopher than as a physicist appears to have hindered attention to his important speculation. When, however, La Place lent the weight of his great name to an almost identical hypothesis, astronomers at once recognized that it must be based on sound dynamic conceptions. Then came the giant telescopes of the Herschels, father and son, and of Lord Rosse, adding the evidence of observation; for they discovered in the sky *nebulæ*, some globular in figure, some disk-like, others annular, and still others even spiral.

Later Developments.—But Lord Rosse's great telescope showed, too, that some at least of the *nebulæ* might be resolved into stars, thereby threatening the subversion of the nebular hypothesis, especially if all the *nebulæ* could be so resolved. Within a few years, however, and just after the middle of the 19th century, application of the principles of spectrum analysis to the *nebulæ* proved conclusively that many of them are composed of glowing gas, and therefore cannot be resolved into stars. About the same time von Helmholtz advanced the accepted theory of the sun's contraction

in explanation of the maintenance of solar heat; and Lane, an American, proved that a gaseous mass condensing as a result of gravitation might actually grow hotter, in spite of its immense losses of heat. Thus it was unnecessary to assume a high temperature of the nebula in the beginning. Also the genius of Lord Kelvin, the eminent English physicist, strengthened the hypothesis by computations on the heat of the sun, and his probable duration of about 20,000,000 years in the past.

Recent Additions.—Then came Darwin, who, in the latter part of the 19th century, demonstrated mathematically the remarkable effects producible by tidal friction, which had been neglected in all previous researches. The gathering of a ring into an embryo planet was a process not easy to explain; and Darwin showed that probably the moon had never been a ring round the earth, but that she separated from her parent in a globular mass, in consequence of its too rapid whirling. He showed, too, how the mutual action of great tides in the two plastic masses would operate to push the moon away to her present remote distance: the terrestrial tidal wave being in advance of the moon, our satellite would tend to draw it backward; also, the wave would tend to pull the moon forward, thereby expanding her orbit, and increasing her mean distance from us. His researches cleared up, also, the enigma of the inner satellite of Mars, revolving round its primary in less time than Mars himself turns on his axis; and no less the newly discovered fact that Mercury and

Venus keep a constant face to the sun, and satellites of Jupiter to their primary, just as the moon to the parent earth. Still later, by adapting these principles to stellar systems, See explained the fact of the great eccentricity of the binary orbits as a result of the long-

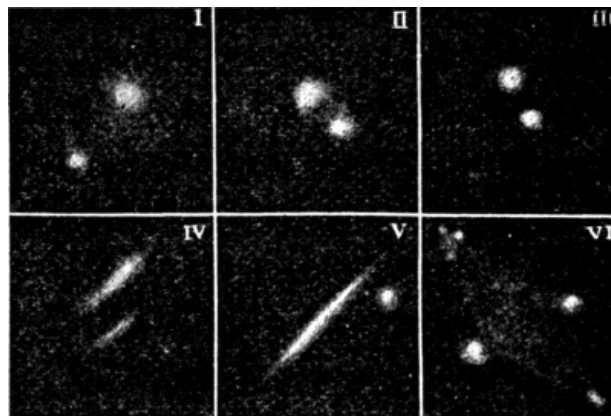

Various Types of Double Nebulæ (Lord Rosse)

continued or secular action of tidal friction. The double stars, then, were originally double nebulæ, separated by a process resembling 'fission' in the case of protozoans. Poincaré has proved mathematically that a whirling nebula, in consequence of contraction, is liable to distortion into a pear-shaped or hour-glass figure, and to ultimate separation. And there is excellent observational proof in the double nebulæ (p. 407) found in

different regions of the heavens.

Evidence supporting the Nebular Hypothesis.—To collect evidence from the entire universe, as at present known:—

(*a*) Scanning the heavens with the telescope, we find numerous nebulæ of forms required by the theory.

(*b*) Spectrum analysis proves a general unity of chemical composition throughout the universe.

(*c*) Stellar evolution necessitates the supposition of birth, growth, and decay of stars,—a requirement met by the fact that types of stellar spectra differ greatly, possibly indicating a wide variation in age of the stars, although this is not yet clearly made out in all detail.

(*d*) Our sun is a star, and its corona resembles such wisps of nebulous light as theory would lead us to expect.

(*e*) The maintenance of solar heat is best explained on the basis of the sun's continual contraction.

(*f*) The planets revolve round the sun, and the satellites round the planets, in nearly the same plane (with few exceptions not difficult to account for).

(*g*) The planets all rotate on their axes (so far as known), also revolve in their orbits round the sun, in the same direction.

(*h*) The zone of small planets circling about the sun, and the triple ring surrounding the planet Saturn, are eminently suggestive and seemingly permanent illustrations of a single stage of the interrupted process of world building in accordance with the nebular hypothesis.

Spiral Nebulæ and the Nebular Hypothesis.—Keeler in 1900 by means of photography made the highly important discovery, not only that the number of nebulæ is greatly in excess of 100,000, but that fully half of them conform in figure to the spiral type. As these objects are flat and their planes lie in all directions in space, the number that are actually spiral must largely exceed those that appear unmistakably so. So we find that, next to the star itself, the spiral nebula is the type of object most abundant in the heavens. Had La Place known of the existence of such nebulæ, he would unquestionably have modified his statement of the nebular hypothesis to accord with this very significant fact. In full accord with the principles of dynamics is the existence of such vast numbers of spiral nebulæ: the progressive development from a formless nebula tends toward the flat, circular, revolving disk, and contraction makes the inner regions revolve more and more rapidly; thus producing the spiral, or whirlpool, structure. Therefore the spiral nebula is a fundamental and pronounced natural form. Thousands of stellar systems, then (probably also our planetary system), came into being, not from rings left behind as the nebular disk contracted, but

by condensation into knots of nebulosity, here and there detached from the whirling nebulous mass, each knot subsequently contracting into a separate star (or planet). The figure on page 402 shows this, and numerous other spiral nebulae indicate the same process equally clearly. This simple modification of the nebular hypothesis obviates the most serious objection to it, viz., the great difficulty in explaining how rings could condense into planets. So Keeler's discovery has greatly strengthened the evidence in general favor of the nebular hypothesis.

Other Universes than Ours.—When considering known stellar distances, we found stars immensely remote from the solar system in all directions; and everywhere scattered among myriads remoter still, whose distances we can see no prospect of ever ascertaining. What is beyond? Outside the realm of fact, imagination alone can answer. We cannot think of space except as unlimited. The concept of infinite space precludes all possibility of a boundary. But the number of stars visible with our largest telescopes is far from infinite; for we should greatly overestimate their number in allowing but ten stars to every human being alive this moment upon our little planet. Are, then, the inconceivable vastnesses of space tenanted with other universes than the one our telescopes unfold? We are driven to conclude that in all probability they are. Just as our planetary system is everywhere surrounded by a roomy, starless void, so doubtless our huge sidereal cluster rests deep in an outer space everywhere enveloping illimitably. So remote must be these external galaxies that unextinguished light from them, although it speeds eight times round the earth in a single second, cannot reach us in millions of years. Verily, infinite space transcends apprehension by finite intelligence. Let us end with Newton, as we began. 'Since his day,' wrote one of England's greatest astronomers in his Cardiff address (1891), 'our knowledge of the phenomena of Nature has wonderfully increased; but man asks, perhaps more earnestly now than then, what is the ultimate reality behind the reality of the perceptions? Are they only the pebbles of the beach with which we have been playing? Does not the ocean of ultimate reality and truth lie beyond?'

INDEX

- Abbe, E. (1840–1905), Ger. ast., 175
aberration
 annual, 140
 constant of, 141
 ellipses, 142, 380
 stellar, 141
aberration time, 291
Achernar (α Eridani), 369
actinometer, 170
Adams, J. C. (1819–92), Eng. ast., 326
Agathocles (B.C. 320), eclipse of, 257
Al-Mamun (A.D. 810), Arab. caliph, 70
Alaska transferred to U. S., 164
Albategnius, M. J. (A.D. 900), Arab. ast., 219
Aldeb'aran, 52, 56, 369, 382, 384
Alexander, S. (1806–83), Am. ast., 263
Algol, 53, 383, 388, 389, 391
Almagest, *see* Ptolemy
Almanac, Nautical, 96, 147
almucantar defined, 26
Alpheratz (α Andromedæ), 59
Altair, 56, 369, 382, 384, 387
altazimuth, 41, 71
altitude
 defined, 40, 49
 measuring, 158
aluminum in sun, 245
Amherst College
 lunar eclipse at, 273
 meteorite collection, 359, 365
Anaximan'der (B.C. 580), Gk. phil., 22, 67
Andromeda, 53, 56
 nebula in, 401
 new star in, 389
Andromedes, meteors, 352, 361, 363
angle of the vertical, 76
angles
 instruments for measuring, 169, 183
 measure of, 38
 relation to distance, 38
Anta'res (α Scorpii), 56, 369, 370, 384
ap'sides, line of, defined, 121
apastron, 394
aphelion, 121
apogee, *see* moon, apogee
Aquarids, Delta, Eta, meteors, 361
Aquarius, 56
Aquila, 56
Archimedes (B.C. 250), Gk. geom., 219
Arcturus, 56, 369, 382, 384, 387
Argelander, F. W. A. (1799–1875), Ger. ast., 370
Argo, 56
Argüs, Eta, nebula, 373, 390, 400
Ariel, satellite of Uranus, 307
Aries, 56
 first of, 33, 95
Aristarchus (B.C. 270), Gk. ast., 219
Aristotle (B.C. 350), Gk. phil., 70, 219
Arzachel, A. (A.D. 1080), Heb. ast., 219
Assyria
 chronology of, 8
 tablets, 257
asteroids, 279, 296, 319
astrographic charts, 372
astrolabe, ecliptic, 47, 48
Astronomer Royal, *see* Bradley, *see*
 Flamsteed, *see* Maskelyne, *see* Halley,
 E., *see* Christie, Sir W. H. M.
astronomy
 before telescopes, 167
 defined, 7
 history, 7, 37, 48, 67, 70, 71, 85, 99, 112,
 115, 143, 167, 175, 178
 language of, 21
 practical defined, 37
 utility of, 8
atmosphere
 of earth, 79, 80
 of moon, 216
 of stars, 371
 of sun, 247
 steady, 168
Aurigæ, Beta, 396
Auriga, 53, 56, 389, 390
aurora, 81
 spectrum, 82
autumn
 in general, 133
 months of, 138
Auwers, A. (ow'verz), Ger. ast., 232, 374
axis, optical, 171
azimuth, defined, 40, 49

Bache, A. D. (bäch) (1806–67), Am.
 physicist, 386
Bailey, S. I., Am. ast., 373, 388
Ball, Sir R. S., Dir. Obs. Cambridge, Eng.,
 55, 382
Barnard, E. E., Prof. Univ. Chicago, 4, 13,
 17, 30, 31, 272, 296, 303, 310, 316,
 344, 350, 354, 356, 359, 397, 399
Bede (bead) 'The Venerable' (A.D. 700), Eng.
 author, 67
Beer, W. (bay'er) (1797–1850), Ger. banker
 and ast., 312
Bélopolsky, A., ast. Pulkowa Obs., 396
Berliner Astron. Jahrbuch, 320
Bessel, F. W. (1784–1846), Ger. ast., 380, 395
Betelgeux (bet-el-gerz'), 56, 369, 370
v. Biela, W. (bē'lä) (1782–1856), Aus. officer,
 350, 352, 358, 364

- Bielids (be'lidz), meteors, 352, 364
 Bigelow, F. H., U. S. Weather Bureau, 266
 Bigourdan, G. (be-goor-dong'), ast. Paris Obs., 393
 binary stars, 394
 eccentricities, 394
 masses, 394
 spectroscopic, 395
 Bisch'offsheim, R., Fr. banker and patron, 178
 Blanpain, M. (1779–1843), Fr. ast., 350
 Bode, J. E., (bō'dūh) (1747–1826), Ger. ast., law of, 295, 319
 bolometer, 170, 246, *see* spectro-bolometer
 Bond, G. P. (1825–65), Am. ast., 325, 393, 403
 Bond, W. C., (1789–1859), Am. ast., 306
 Boötes, 53, 56
 Boss, L., Dir. Dudley Obs., 372, 375
 box-transit, 103
 Boyden, U. A. (1804–79) Am. engineer and patron, 168, 386
 brachy-telescope, 179
 Bradley, J. (1693–1762), Ast. Royal, 141
 Brashear, J. A., 168, 178, 181, 241, 248
 Bredichin, T. A. (1831–1904), Russ. ast., 346
 Brenner, L., ast. Obs. Lussinpico, 325, 326
 British Museum meteorites, 359, 365
 Brooks, W. R., Dir. Obs. Geneva, 344, 350, 354, 358
 Brorsen, T. (1819–93), Ger. ast., 310, 344
 Bruce telescope, 12, 373
 Bruce, C. W. (1816–1900), Am. patron, 372
 Bulletin Astronomique (Paris monthly), 252
 Burnham, S. W., Univ. Chicago, 393, 394

 cadmium in sun, 245
 Cæsar, Julius, reforms calendar, 143
 calcium
 flocculi, 250
 in sun, 239, 245, 250
 calendar, 143
 reform of, 143, 144
 calorie defined, 253
 Camelopardalis, 53
 Campbell, W. W., Dir. Lick Obs., 308, 385, 396, 403
 canals of Mars, 314, 315
 Cancer, 56
 tropic of, 139
 Canes Venatici, 53, 56
 nebula in, 402
 Canis major, 56
 Canis minor, 56
 Cano'pus (α Argûs), 369, 375
 Cape of Good Hope
 Obs., 372
 tide, 154
 Capella, 53, 369, 370, 382–385, 390, 396
 Capricornus, 56
 tropic of, 139
 carbon
 in comets, 355
 in meteorites, 365
 in stars, 384
 in sun, 245
 cardinal
 directions in sky, 36
 points, 21
 Carina, Eta, 373
 spectra, 386
 Carnegie Solar Obs., 168, 180, 250
 Cassegrainian telescope, *see* telescope, Cassegrainian
 Cassini, J. D. (kas-se'ne) (1625–1712), It.-Fr. ast., 306, 314, 321, 325
 Cassiopeia, 53, 101, 374, 389
 Castor (α Geminorum), 56, 393, 396
 Centauri, Alpha, 18, 369, 381, 382, 394
 Centaurus, 56
 Cepheus (se'fuce), 53
 Ceres, first small planet discovered, 290, 295, 296, 319
 Cetus, 56
 Chaldean view of comets, 343
 Chandler, S. C., ed. *Astron. Jour.*, 83, 388
 Charles II (1630–85), Eng. king, 377
 Charlois, A. (shar-lwah'), ast. Nice Obs., 319
 Chinese annals, 257, 388
 chlorine
 in comets, 346
 not in sun, 245
 Christie, Sir W. H. M., Ast. Royal, 4, 377
 chromium in sun, 245
 chromosphere, solar, 248, 250
 chronograph, 170, 188
 photo-chronograph, 189
 printing, 189
 chronology, 8
 chronometer, marine, 148, 170
 circle
 division of, 37
 graduated, 169
 great, courses, 164
 great, defined, 26
 vertical, defined, 26, 49
 Clark, A. (1804–87), A. G. (1832–97), G. B. (1827–91), 15, 168, 178, 394
 Clarke, J. F. (1810–88), Am. theol., 55
 Clavius, C. (1537–1612), Ger. math., 219
 Cleome'des (A.D. 150), Gk. ast., 70
 clep'sydra, ancient, 99
 Clerke, A. M. (1842–1907), Eng. ast., 384
 clock, 170, 186
 error of, 187
 clusters
 globular, 397
 stellar, 397
 cobalt in sun, 245

- Coggia, G. (ko'jha), ast. Obs. Marseilles, 353, 354
- collimation, line of, 186
- collimator, 240
- Columba, 56
- colure, 48
 defined, 31, 49
 equinoctial, 58
- Coma Bereni'ces, 56
- comets, 18, *see* Donati's comet, 343
 appearance, 344
 changes, 345
 chemical composition, 355
 collision, 357
 coma, 344
 connection with meteors, 364
 constitution, 346
 density, 356
 dimensions, 349
 discoveries, 344, 356
 disintegration, 352, 358
 earth passes through, 357
 families, 349
 greatest, 353
 groups, 351
 head, 344
 light, 355
 mass, 356
 motion, 349
 next to come, 354
 nucleus, 344
 number, 351
 observations, 347
 orbit, 347
 origin, 358
 periodic, 349
 photography, 355
 remarkable, 353, 354
 superstitions, 343
 tail, 345–347
 tandem, 351, 358
 velocity, 347
- Common, A. A. (1841–1903), Eng. ast., 180, 322
- Comstock, G. C., Dir. Obs. Univ. Wis., 393
- conjunction
 in right ascension, 282
 moon's, 206
 planets', 280, 282
- constellations, 14, 51, 374
- contacts
 in eclipses, 264
 in transits, 300
- Copernicus, N. (1473–1534), Ger. ast., 85, 219, 343
- Copernicus, N. (1473–1534), Ger. ast., 219, 222, 223, 278
- copper in sun, 245
- Cornu, M. A. (1841–1902), Fr. physicist, 124, 247
- corona, 253, 257, 263, 265, 266
 periodicity, 266
 rotation, 266, 268
 spectrum, 266, 268
 streamers, 267
- Corona Australis, 56
- Corona Borealis, 56
 nova, 389
- coronium, 266, 268
- Corvus, 56
- Cosmas (A.D. 550), Egypt. geographer, 67
- cosmogony, 367, 404
- cotidal lines, 154
- Coudé (coo-day'), equatorial, 192
- Crater, 56
- crater, *see* Triesnecker crater
- crater, lunar, 219, 220, 222
- Crew, H., Prof. Northwestern Univ., 239
- Cygni, *see* Deneb
- Cygni 61, 380, 382, 393
- Cygnus, 53
 nova of, in 1876, 389
- d'Alembert, J. B. le R. (dä-long-bêr')
 (1717–83), Fr. math., 219
- d'Arlandes, F. L. (där-lond') (1742–1809), Fr. marquis, 258
- D'Arrest, H. L. (där-rest') (1822–75), Ger. ast., 350
- Daguerre, L. J. M. (dä-gêr') (1789–1851), Fr. painter, 193
- Darwin, G. H., Prof. Univ. Cambridge, Eng., 299, 407
- day, 87, *see* night
 apparent solar, 95
 astronomical, 96
 change of, 163
 civil, 96
 length of, 92
 mean solar, 96
 sidereal, 94
 sidereal and solar compared, 126
- De Vico, F. (1805–48), It. ast., 350
- declination
 axis, 45
 circle, 45
 defined, 43, 49
 parallels of, 30
- decrecent, *see* moon, decrecent
- deferent circle, 278
- Delphinus, 56
 variable in, 391
- Dembowski, L. (1815–91), Ger. ast., 393
- Deneb, (α Cygni), 53, 369
- Denning, W. F., Eng. ast., 321, 350, 361
- Deslandres, H. (day-londr'), ast. Meudon Obs., 249, 266, 267, 387

- Di'ò-ne, satellite of Saturn, 306
 diamond in meteorites, 365
 diffraction
 rings, 176
 spectroscope, 241
 spectrum, 242
 dip of the horizon, 160
 Dipper, 53, 101, 374
 directrix of parabola, 348
 distance, *see* sun, distance, *see* moon,
 distance
 stars, 378–382
 diurnal, motion and arc, 27
 Doerfel, G. S. (1643–88), Ger. ast., 219
 Dollond, J. (1706–61) Eng. opt., 175
 Dona'ti, G. B. (1826–73), It. ast., 344
 Donati's comet (of 1858), 18, 344–346, 349,
 353
 Doolittle, C. L., Dir. Obs. Univ. Penn., 75, 83
 Doppler's principle, 246, 247, 376, 395
 Doppler, C. (1803–53), Ger. physicist, 376
 double stars, 392, *see* binary stars, 393
 colored, 370
 optical doubles, 393
 orbits, 394
 origins, 407
 Douglass, A. E., Am. ast., 305, 309, 310
 Draconis, Alpha, 113
 Draper catalogue, star spectra, 386
 Draper, H. (1837–82), Am. ast., 181, 355,
 387, 403
 Mrs. H., 386
 Dreyer, J. L. E., Dir. Obs. Armagh, 400
 Dunér, N. C., Dir. Obs. Upsala, 239
 Dyson, F. W., Eng. ast., 375
- Earth
 density, 297
 diameter, 296
 distance, 290
 eccentricity, 288
 period, 289
 earth
 affected by sun spots, 238
 ancient idea of, 67
 atmosphere, 79
 axial inclination, 298
 axis moving in space, 112
 curvature, 67
 direction of motion in space, 117
 ellipticity, 298
 form found by pendulums, 77
 mass, 78
 measurement, 70
 motion in orbit, 122, 125
 oblateness, 72
 orbit, *see* orbit (earth), 286, 313
 path in space, 375
 proof of motion, 141, 142
 revolves around the sun, 115
 rotation, 298
 size, 72
 size of orbit, 124
 turns on its axis, 85, 86
 uniformity of rotation, 109
 volume, 72
 why it does not fall into the Sun, 335
 earthquakes and moon, 217
 Easter Sunday, 145
 Eastman, J. R., U. S. Navy (ret.), 190
 Easton, C., Dutch ast., 399
 eclipse seasons, 273
 eclipses of Jupiter's satellites, 304
 eclipses, lunar, 269, 270
 dates of, 272
 frequency of, 272
 moon visible during, 271
 recurrence, 274
 total, 272
 eclipses, solar, 257–269
 ancient, 257
 annular, 259, 263
 causes of, 258
 dates of, 263, 268, 269
 frequency of, 272
 life history of, 274
 number in year, 261
 partial, 259, 262
 prediction of, 19, 269, 274
 recurrence, 274
 total, i, 257, 259, 263, 264
 ecliptic, 47, 49, 56, 116
 apparent motion, 34
 north polar distance, 47
 origin of, 260
 ecliptic limit
 lunar, 271
 solar, 261
 ecliptic system
 circles of, 26, 32, 49
 glides over horizon system, 33
 origin of, 47
 Edgecomb, W. C., Am. opt., 181
 Elkin, W. L., Dir. Yale Obs., 320, 359, 380
 Ellery, R. L. J. (1827–1907), Eng. ast., 184
 ellipse
 comet orbit, 347
 defined, 120
 eccentricity, 120
 how to draw, 120
 limits of, 120
 parallactic, 379
 Enceladus, satellite of Saturn, 306
 Encke, J. F. (eng'küh) (1791–1865), Ger. ast.,
 346, 349, 350, 352
 Ephemeris, 104, 106, 305
 epicycle, 278
 equation of time, 97

- explained, 130
 equator, 56
 celestial defined, 30, 49
 terrestrial, daily motion of stars at, 63
 equator system
 circles of, 26, 29, 49
 glides over horizon system, 32
 origin of, 42
 equatorial girdle of stars, 56
 equatorial telescope, 44, 168
 adjusting, 45
 mounted
 at equator, 65
 at poles, 65
 equinoctial, defined, 43
 equinoxes, 33
 defined, 33
 how to find, 58
 motion of, 110
 position of, 112, 113
 precession, 110, 341
 Er'icsson, J. (1803–89), Swed.-Am. eng., 253
 Eratos'thenes (B.C. 240), Alex. geom., 70
 Eros, 291
 escapement, 187
 gravity, 187
 ether, luminiferous, defined, 38, 123
 Euclid (B.C. 280), Gk. geom., 37, 43
 Eudoxus (B.C. 370), Gk. ast., 51, 219
 Everett, Miss A., Eng. ast., 394
 evolution, tidal, 299, 407
 eyepiece, 170, 182
 negative, 182
 positive, 182
- faculæ, *see* sun, faculæ
 Fargis, G. A., Am. ast., 190
 Faye, H. A. E. A. (fy) (1814–1902), Fr. ast., 350
 Fernel, J. (fair-nel') (1497–1558), Fr. geod., 70
 Finlay, W. H., ast. Capetown Obs., 350
 Flammarion, C. (flam-ma-re-ong'), Dir. Juvisy Obs. (Paris), 57, 156
 Flamsteed, J. (1646–1719), Ast. Royal, 219
 Fleming, Mrs. W. P., Am. ast., 386, 389
 Flint, A. S., Am. ast., 382
 flocculi, 250
 Fomalhaut (fō'mal-ō), 56, 369
 Fornax, 56
 Foucault, J. B. L. (foo-kō') (1819–68), Fr. physicist, 87
 Fracastor, J. (1483–1553), It. physician, 219
 v. Fraunhofer, J. (frown'hō-fer) (1787–1826), 168, 386
 Fraunhofer lines, 240, 243, 245, 247, 250
 Frost, E. B., Prof. Univ. Chicago, 7, 253, 396
- Gale, W. F., Australian ast., 356, 400
 Galile'i, G. (1564–1642), It. ast., 12, 167, 172, 282, 303, 327
 gases, kinetic theory of, 216
 Gassendi, P. (1592–1655), Fr. ast., 219, 301
 gegenschein (gay'gen-shine), 280, 310
 Gemini, 56
 Geminids, meteors, 361
 Geminus (B.C. 50), Gk. ast., 219
 geodesy, 8
 defined, 70
 Gerrish, W. P., Am. ast., 319
 Gill, Sir D., Scotch ast., 320, 372, 380, 400
 Glasenapp, S. P. (gläz'näp), Dir. Obs. Saint Petersburg Univ., 393
 glass
 Jena (yay'na), 194
 new, 175, 194
 optical, 172
 gnomon, 21, 70, 99
 goal, sun's, 375
 v. Gothard, E. (go'tar) (1857–1909), Hungarian ast., 400
 Gould, B. A. (1824–96), Am. ast., 369, 393
 Graham, T., (graim) (1805–69), Scot. chem., 366
 gravitation, 19
 argument for universal, 327
 explains tides, 338
 holds moon in orbit, 330
 holds planets in orbit, 331
 law of, 291, 334, 336, 395
 gravity
 common center of, 333
 distinct from gravitation, 336
 terrestrial, 76
 Great Bear, 53, 54
 great circle, *see* circle, great
 Greek alphabet, 51
 Green, N. E. (1823–99), Eng. ast., 312
 Greenwich
 in navigation, 150, 159
 meridian of, 107
 Observatory, 178, 322, 376
 Gregorian telescope, *see* telescope, Gregorian
 Gregory XIII, reforms calendar, 143
 Gregory, J. (1638–75), Scot. math., 178
 Gregory, R. A., Eng. ast., 383
 Grimaldi, F. M. (1618–63), It. physician, 219
 Groombridge, S. (1755–1832), Eng. ast., 382
 Grubb, Sir H., Brit. opt., 178
 Grubb, T., (1800–78), Brit. opt., 180

- Hadley, J. (1682–1744), Eng. math., 158
Hagen, J. G., Dir. Vatican Obs. Rome, 388
Hale, G. E., Dir. Carnegie Solar Obs., 4, 238, 248, 249
Hall, A., Jr., Am. ast., 337
Hall, A. (1829–1907), Am. ast., 303, 393
Hall, C. M. (1703–71), Eng. math., 175
Halley, E. (1656–1742), Ast. Roy., 345, 349, 352, 354, 390
Hamilton, Sir W. R. (1805–65), Brit. math., 7
Hansen, P. A. (1795–1874), Ger. ast., 130
Harkness, W. (1837–1903), Am. ast., 267
Harvard College
 meteorite collection, 359
 obs., 10, 12, 180, 251, 368, 372, 386, 389, 391
Hastings, C. S., Prof. Yale Univ., 168, 175
heat, *see* moon, heat, *see* sun, heat
 at summer solstice, 135
 sun's greatest at midday, 135
helium, 169, 231, 232, 380
helioscope, 233
helium, 248
 in meteorites, 366
 in nebulae, 402
 in stars, 387, 390
v. Helmholtz, H. L. F. (1821–94), Ger. physicist, 254, 406
Henderson, A., Eng. ast., 322
Henry, A. J., U. S. Weather Bureau, 9
Henry, Paul (ong-ree') (1848–1905), Fr. ast., 14, 178, 220, 356
Henry, Prosper (ong-ree') (1849–1903), Fr. ast., 14, 178, 220, 356
Hercules, 53, 56
Herodotus (B.C. 460), Gk. hist., 67, 219
Herschel, Miss C. L. (1750–1848), Eng. ast., 344
Herschel, Sir F. W. (1738–1822), Eng. ast., 179, 180, 219, 307, 314, 325, 393, 399, 406
Herschel, Sir J. F. W. (1792–1871), Eng. ast., 295, 357, 406
Hesperia, on Mars, 318
Hevelius, J. (1611–87), Ger. ast., 219, 239
Higgs, G., Eng. physicist, 244
Hill, G. W., Am. ast., 197
Hipparchus (B.C. 140), Gk. ast., 57, 112, 219, 278, 371, 388
Holden, E. S., Am. ast., 404
Holmes, E., Eng. ast., 350
horizon
 apparent, 23
 dip of, 160
 ocean, 24
 rational, 25, 49
 sensible, 23
 visible, 23
horizon system
 circles of, 26
horology, 187
Horrox, J. (1617–41), Eng. ast., 302
Hough, G. W. (huff) (1836–1909), Am. ast., 189, 322
hour circle, 30, 49
 of telescope, 45
Huggins, W. (1824–1910), Eng. ast., 355, 384, 402
Huxley, T. H. (1825–95), Eng. biologist, 2
Huygenian eyepiece, 182
Huygens, C. (hy'genz) (1629–95), Dutch ast., 167, 306, 312, 324
hydrocarbons, in comets, 346, 355
hydrogen
 in earth's atmosphere, 216
 in meteorites, 366
 in moon's atmosphere, 216
 in nebulae, 402
 in stars, 384, 387, 390
 in sun, 245
 outbursts in stars, 392
Hype'ron, satellite of Saturn, 306
hyperbola
 comet orbit, 347
Iapetus (e-ap'e-tus), satellite of Saturn, 306
instruments classified, 169
iron
 in comets, 346, 355
 in sun, 245
James, A. C., D. W., Am. patrons, 2
Janssen, P. J. C. (1823–1907), Fr. ast., 234
Jena glass, *see* glass, Jena
Jeroboam II (B.C. 770), Assyrian monarch, 8
Jewell, L. E., Am. physicist, 239, 244
Juno, small planet, 295, 296, 319
Jupiter
 albedo, 294
 atmosphere, 308
 belts, 320
 center of gravity of sun and, 297
 chart of, 322
 color, 294
 density, 297
 diameter, 296
 distance, 290, 295
 drawings, 16, 320–322
 eccentricity, 288
 ellipticity, 298
 family of comets, 350
 great red spot, 321
 libration, 299
 mass, 297
 naked-eye appearance, 279
 orbit, 287
 period, 289
 phase, 283

- photography, 322
- rotation, 298
- satellites, 303–305
- surface, 320
- variation in size, 294
- Kant, I. (kânt) (1724–1804), Ger. phil., 11, 406
- Kapteyn, J. C., Univ. Groningen, 372, 384, 399
- Keeler, J. E. (1857–1900), Am. ast., 308, 309, 320, 325, 400, 403, 404, 408
- Kepler, J. (1571–1630), Ger. ast., 122, 219, 327, 343, 372, 389
 - laws, 289, 325, 330, 331, 333, 335, 337
- Kimball, A. L., Prof. Amherst College, 4
- Kirchhoff, G. R. (keerk'hof) (1824–87), Ger. physicist, 167, 243
- Klein, H. J., Ger. ast., 55
- Kranz, W. (krönts), Ger. painter, i
- La Grange, J. L. (lā-grönzh') (1736–1813), Fr. math., 122, 292
- La Place, P. S. de (lä-plass') (1749–1827), Fr. ast. and math., 2, 292, 406, 408
- Lacerta, 56
- Landreth, O. H., Prof. Union Coll., 192
- Lane, J. H. (1819–80), Am. physicist, 407
- Langley, S. P. (1834–1906), Am. ast. and physicist, 217, 246, 247, 253, 308
- Lassell, W. (1799–1880), Eng. ast., 180, 307
- latitude
 - finding at sea, 159
- latitude (celestial), 47, 49
 - parallels of, 33
 - precession does not effect, 113
- latitude (terrestrial)
 - equals altitude of pole, 61
 - finding, 61, 72, 74
 - length of degrees, 75
 - origin of term, 67
 - variation of, 83
- latitude-box, 71, 72
- Le Verrier, U. J. J. (lüh-vay-rya') (1811–77), Fr. ast., 130, 326
- Leavenworth, F. P., Prof. Univ. Minn., 393
- v. Leibnitz, G. W. (līb'nits) (1646–1716), Ger. math. and phil., 219
- Leibnitz Mountains, 222
- lenses, 170–175, 177, 182
- Leo, 56
- Leo Minor, 56
- Leonids, meteors, 361–364
- Lepus, 56
- Lexell, A. J. (1740–84), Swed. math., 350
- Libra, 56
- Lick Observatory, 168, 181, 186, 221, 304, 316, 322, 356, 378
- Lick telescope, 178, 369
- light
 - moves in straight lines, 38
 - velocity of, 123, 305
- light year, unit of distance, 381
- Lindsay, Lord, Scot. noble and ast., 266
- Lockyer, Sir J. N., Eng. ast., 387, 390, 392
- Loewy, M. (1833–1907), Fr. ast., 192
- longitude
 - (terrestrial) ascertaining by telegraph, 107
 - defined, 107
 - finding at sea, 159
 - of stars changes by precession, 113
- longitude (celestial), 48, 49
 - length of degrees, 75
 - origin of term, 67
- Lovell, J. L., photographer, 101, 348
- Lowell, P., Am. ast., 310–312, 315–318
- lunar eclipses, *see* eclipses, lunar
- lunation, *see* moon, lunation
- Lynx, 56
- Lyræ
 - beta, 387, 389
 - epsilon (ep-si'lon), 396
- Lyra, 56
 - ring nebula in, 400
- Lyrids, meteors, 361
- v. Mædler, J. H. (med'ler) (1794–1874), Ger. ast., 312
- magnesium
 - in comets, 355
 - in sun, 245
- magnetic disturbances, 217, 238
- magnifying power, 183
- manganese in sun, 245
- Mantoiis, M. (man-twä'), Fr. glass-maker, 15
- Mars, *see* canals of Mars
 - albedo, 294
 - atmosphere, 308
 - axial inclination, 298
 - color, 294
 - density, 297
 - diameter, 296
 - distance, 290, 295
 - eccentricity, 288
 - ellipticity, 298
 - libration, 299
 - markings on, 315
 - mass, 297, 338
 - naked-eye appearance, 279
 - oases, 314
 - opposition, 313
 - orbit, 286, 313
 - period, 289
 - phase, 283
 - polar caps, 308, 314, 316
 - rotation, 298
 - satellites, 303
 - seasonal changes, 318

- surface of, 312
 terminator, 313
 twilight arc, 308
 variation in size, 293
 water on, 312
 Martin, M. A. (mär-tang'), Fr. opt., 178, 180
 Mascari, A., ast. Catania Obs., 311
 Maskelyne, N. (1732–1811), Ast. Royal, 219
 Maunder, E. W., ast. Obs. Greenwich, 383, 399
 Maury, Miss A. C., Am. ast., 386
 mean noon, *see* noon (mean)
 Mercury
 albedo, 294
 atmosphere, 307
 color, 294
 conjunctions, 280
 density, 297
 diameter, 296
 distance, 290, 295
 eccentricity, 288
 greatest brilliancy, 280
 greatest elongation, 281
 inclination, 288
 libration, 299
 mass, 297
 naked-eye appearance, 278
 orbit, 286
 period, 289
 phase, 282
 rotation, 298
 surface of, 310
 transits, 300, 301
 meridian, 26, 49
 arc, 72
 circle, 75, 168, 192
 mark, 101
 Messier, C. (mes'se-ā) (1730–1817), Fr. ast., 344
 meteorites, 18, 359
 analysis, 365
 carbon in, 365
 falls of, 364
 form irregular, 365
 meteoritic theory, 390, 392
 meteors, 18, 343, 359–362, 364
 Meudon Observatory, 178
 Michelson, A. A., Prof. Univ. Chicago, 124
 micrometer, 169, 183, 184
 midnight sun, 92
 midsummer, 28, 129
 midwinter, 127, 128, 136
 Milky Way, 13, 398
 lanes, 399
 Mimas, satellite of Saturn, 306
 Mira, 384, 388, 389
 Mizar, star in Ursa Major, 101, 396
 Molesworth, P. B. (1867–1908), Eng. ast., 317
 Monc'eros, galaxy in, 13, 56
 Montaigne, M. (1716–85), Fr. ast., 352
 moon, 14, 197, *see* crater, lunar, *see* eclipses,
 lunar
 angular unit, 40
 apogee, 202, 207
 apparent diameter, 211
 apparent orbit, 205
 apparent size, 214
 atmosphere, 216
 changes on, 221
 daily retardation, 201
 decreascent, 201
 deviation, 211
 dimensions, 211
 distance, 207, 210
 earth shine on, 201
 features, 218
 gibbous, 199
 gravity at surface, 214
 harvest, 202, 203
 heat, 217
 hunter's, 202
 inclination of orbit, 205
 librations, 215
 light, 217
 lunation, 205
 maps, 219
 mass, 214
 motion, 197
 mountains on, 221, 222
 nodes, 205, 206, 260, 261
 north and south motion, 201
 orbit in space, 206
 parallax, 208, 209
 Paschal, 145
 perigee, 202, 207
 period, 203, 204
 phases, 198–200
 photographs, 14, 219
 quadrature, 199
 rills, 224
 rotation, 215
 seas, 218
 streaks, 222
 syzygy, 206
 temperature, 217
 terminator, 198
 visit to, 224
 volcanoes, 221
 water on, 216
 weather, 217
 Moreux, T. (mo-rō'), Fr. ast., 11
 motion
 curvilinear, 332, 334
 defined, 327
 laws of, 327–329
 of stars in sight line, 376
 Mouchot, A. (moo-show'), Fr. phys., 253
 museums, astronomical, 48

- nadir, 22
 defined, 22
- Naples, Bay of, 221
- navigation, 8
 astronomy of, 147, 377
- nebulae
 annular, 400
 classified, 400
 distance, 404
 double, 407
 elliptic, 400
 irregular, 400
 Orion, 403
 planetary, 385, 400, 402
 spectra, 402
 spiral, 400, 402, 408
- nebular hypothesis, 406, 408
- Neptune
 albedo, 294
 atmosphere, 309
 axial inclination, 298
 Bode's law, 295
 color, 294
 density, 297
 diameter, 296
 discovery of, 326, 333
 distance, 295
 eccentricity, 288
 mass, 297
 orbit, 287
 period, 289
 rotation, 298
 satellite, 304, 307
 sun seen from, 368
 surface of, 325
- Newcomb, S. (1835–1909), *Am. ast.*, 4, 110, 124, 145, 197, 319, 372
- Newton, H. A. (1830–96), *Am. ast.*, 359
- Newton, Sir I. (1642–1727), *Eng. ast.*, 70, 168, 172, 173, 219, 327–329, 334, 342, 343, 409
- Newtonian law, 291, 334
- Newtonian telescope, *see* telescope, Newtonian
- Nice (nēce), Observatory of, 178
- nickel in sun, 245
- night, 87, *see* day
 at equator, 90
 at equinoxes, 88
 at solstices, 89
 long polar, 93
 south of equator, 89
- nitrogen
 in meteorites, 366
 not in sun, 245
- nodes, *see* moon, nodes
- noon (mean), 96
 sidereal time of, 105
- Norma, 56
 new star in, 390
- north polar distance, defined, 43
- north polar heavens, 53
- north, finding true, 100
- notation system
 Eng., 35
 Fr., 35
- nutration, 341
- Oberon, satellite of Uranus, 307
- objective, 170
 achromatic, 174
 efficiency, 175
- obliquity, 130
 of ecliptic, 130
- observatories, 167
 best sites, 168
- occlusion of gases, 366
- occultations, 274
 Jupiter's satellites, 305
- Oceanus, river of mythology, 67
- Olbers, H. W. M. (1758–1840), *Ger. ast.*, 320
- Omicron (o-mi'kron) Ceti variables, 388, 389
- Ophiuchus (oph-i-ū'kus), Kepler's star in, 389
- opposition of planets, 282
- orbit (earth), 116, 121, 122
 an ellipse, 119
- orbit (planetary), 285
 elements, 292
 experimental, 332
 secular variations, 122, 292
- Ori'on, 56, 374
- Orionids, meteors, 361
- oxygen in sun, 245
- Palisa, J. (pa-le'sa), *ast. Vienna Obs.*, 319
- Pallas, small planet, 295, 296, 319
- Panthéon (pon-tā-awng), Paris, 87
- parabola
 comet orbit, 347, 348
- parallactic ellipse, star's, 379
- parallax, *see* moon, parallax, *see* sun,
 parallax
 annual, 379
- Paris
 Museum, meteorites, 359
 Observatory, 48, 107, 178, 181, 192, 220, 221
- Paschal moon, *see* moon, Paschal
- Paul, H. M., Prof. U. S. Navy, 391
- Payne, W. W., *Am. ast.*, 350
- Pegasus, square of, 56, 59
- Peirce, C. S. (purse), *Am. geom.*, 78
- pendulum, 77, 186, 187
- periastron, 394
- perigee, *see* moon, perigee
- perihelion, defined, 121
- perpetual apparition, 63
- perpetual occultation, 63

- Perrine, C. D., Dir. Argentine Nat. Obs., 304, 400
- Perrotin, J. H. (1846–1904), Fr. ast., 316
- Perseids, meteors, 361, 363, 364
- Perseus (per'suce), 53, 56, 389, 390, 397, 398
- personal equation, 189
machine, 190
- Petavius, D. (1583–1652), Fr. chronologist, 219
- Peters, C. H. F. (1813–90), Am. ast., 319
- Phoebe, satellite of Saturn, 306
- photo-chronograph, 189
- photography
celestial, 193, 322, 323
discoveries by, 195, 397
of moon, 14, 219, 398
of nebulae, 400–403
of stars, 13
of sun, 234, 238, 240, 243, 246, 248, 250
spectra, 378, 386
- photometer, 170
- photosphere, 234, 235, 250
- Piazzi, G. (pe-at'si) (1746–1826), It. ast., 319
- Picard, J. (pe-car') (1620–82), Fr. geom., 70, 167
- Pickering, E. C., Dir. Harv. Coll. Obs., 4, 194, 368, 384, 386, 387, 391
- Pickering, W. H., Prof. Harv. Univ., 305, 306, 316, 317, 403
- Pigott, E. (1768–1807), Eng. ast., 350
- Pilâtre de Rozier, J. F. (pee-löttr' düh-ro-ze-ä') (1756–85), Fr. aeronaut, 258
- Pisces, 56
- Piscis Australis, 56
- planetary system, evolution of, 405, 406
- planets, 16, *see* Jupiter, Mars, Mercury, Neptune, Saturn, Uranus, Venus, 277
albedo, 294
apparent motions, 277
apparent size, 293
aspects, 280
atmospheres, 307
axial inclination, 298
classifications, 279
colors, 294
configurations, 280, 282
conjunction, 280
densities, 297
different from stars, 16
dimensions, 296
disk of, 16, 283, 293
distance, 288, 290, 295
eccentricity, 288
ellipticity, 298
elongation, 281
evolution, 406
exterior, 279
exterior to Neptune, 326
farthest, 291
heliocentric movements, 286, 287
inclination, 288
inferior, 279, 280
inferior, configuration, 280
intramercurian, 279
laws of, 289
libration, 298
loop of path, 283
major, 279
mass found (by satellite), 337
mass found (without satellite), 337
masses, 297
measuring diameter, 184
minor, 279
motion (in epicycle), 278
naked-eye appearance, 278
nearest, 291
nodes, 288, 301, 302
opposition, 282
orbit elements, 292
orbits, 286, 287
periods, 288, 289
phases, 282
quadrature, 282
relative sizes, 296
retrograde motion, 284
rotation, 298
satellites, 303
secular variations, 122, 292
small, 279, 319
superior, 279, 280
superior, configuration, 282
superior, loop of path, 283
surfaces, 309
terrestrial, 279, 285
transits, 300
- Plato (B.C. 390), Gk. phil., 67, 219
- Pleiades (ple'ya-deez), 112, 195, 210, 375, 386, 397
- plumb-line, 22
- Poincaré, H. (pwang-kä-ray'), Prof. Univ. Paris, 407
- polar axis, 44
- Polaris, 29, 52–54, 59, 61, 382, 384, 393, 396
- pole
celestial north, defined, 30
finding the, 29
wandering terrestrial, 82
- Pole Star, *see* Polaris
- Pollux (β Geminorum), 56, 369, 384
- Pons, J. L. (1761–1831), Fr. ast., 344, 352
- Popular Astronomy* (monthly), 316, 350, 388
- Porter, J. G., Dir. Cincinnati Obs., 374, 375
- Posidonius (B.C. 260), Gk. phil., 70
- Pratt, H. (1838–91), Eng. ast., 323
- precession, 110, 341
effects of, 112, 371
model to illustrate, 110

- Preston, E. D. (1851–1906), *Am. phys.*, 78, 83
 prime vertical, defined, 26, 49
Principia, Newton's, 327
 prism, comparison, 244
 Pritchett, C. W. (1823–1910), *Am. ast.*, 321
 Pritchett, H. S., *Am. ast.*, 267
 Proclus (A.D. 450), *Gk. phil.*, 219
 Proctor, R. A. (1837–88), *Am. ast.*, 55, 375, 404
 Procyon, 56, 382, 384
 prominences, 9, 10, 248, 249, 251
 Ptolemaic system, 278
 Ptolemy, C. (tol'-em-mi) (A.D. 140), *Alex. ast.*, 71, 219, 278, 372
 Almagest, 278
 Pulkowa (pul-ko'va) *Obs.*, 178, 195, 378
 pyrheliometer, 170
 Pythagoras (B.C. 530), *Gk. phil.*, 67, 343
- Quadrantids, meteors, 361
 quadrature, *see* moon, quadrature, *see* planets, quadrature
 Quéniisset, F. (kay-nis'say), *Fr. ast.*, 346
 quit, sun's, 375
- radian, angular unit, 40
 radiant, meteoric, 360
 radius vector, 119, 121
 Ramsay, W., *Prof. Univ. Col. London*, 248
 Ramsden, J. (1735–1800), *Eng. opt.*, 182
 Ranyard, A. C. (1845–94), *Eng. ast.*, 383
 Rayet, G. (ry-ā'), *Univ. Bordeaux*, 385
 Rees, J. K. (1851–1907), *Am. ast.*, 83
 reflector, 169, 172, 178–181
 refraction, atmospheric, 79
 refractor, 169, 171, 172, 178, 181
 Regulus (α Leonis), 56, 369, 384
 Repsold, J. A., *Ger. instrument maker*, 178
 reticle, 184–186
 reversing layer, 250, 265, 268
 Rhea, satellite of Saturn, 306
 Riccioli, G. B. (rit-se-o'le) (1598–1671), *It. ast.*, 220
 Richaud, M. (re-show') (1650–1700), *Fr. ast.*, 394
 Richer, J. (re-shay') (1640–96), *Fr. ast.*, 77
 Rigel (β Orionis), 56, 369, 393
 right ascension, defined, 43, 49
 Ritchey, G. W., *Am. ast.*, 194, 400
 Roberts, I. (1829–1904), *Eng. ast.*, 4, 397, 398, 400–403
 Roemer, O. (reh'mer) (1644–1710), *Danish ast.*, 184, 305
 Rogers, W. A. (1832–98), *Am. ast.*, 55
 Rordame, A., *Am. ast.*, 346
 Rosse, Lord (1800–67), *Brit. ast.*, 180, 402, 406, 407
 Rowland, H. A. (rō'land) (1848–1901), *Am. physicist*, 168, 242, 244
- Runge, C. (roong'eh), *Ger. physicist*, 245
 Russell, H. C. (1836–1907), *Eng. ast.*, 322, 399, 400
- Saegmüller, G. N. (seg'miller), 190
 Safford, T. H. (1836–1901), *Am. ast.*, 372
 Sagittarius, 56
 Saros, cycle of eclipses, 274
 Saturn
 albedo, 294
 atmosphere, 308
 axial inclination, 298
 color, 294
 density, 297
 diameter, 296
 distance, 290, 295
 drawings, 17, 323
 eccentricity, 288
 ellipticity, 298
 inclination, 288
 libration, 299
 mass, 297, 337
 naked-eye appearance, 279
 orbit, 287
 period, 289
 phase, 283
 photographs, 322
 polar flattening, 323
 satellites, 304, 306
 surface, 322
 Sawyer, E. F., *Am. ast.*, 388
 scandium in sun, 245
 Schaeberle, J. M. (sheb'bur-ly), *Am. ast.*, 266, 356
 Scheiner, J., *ast. Potsdam Obs.*, 387
 Schiaparelli, G. V. (skap-pa-rell'ly) (1835–1910), *It. ast.*, 315, 316
 Schickard, W. (1592–1635), *Ger. math.*, 219
 Schiehallion, Mt., in Scotland, 78
 Schiller, J. C. F. (1759–1805), *Ger. poet*, 219
 Schjellerup, H. C. F. C. (1827–87), *Danish ast.*, 385
 Schuster, A., *Prof. Victoria Univ.*, 267, 356
 Schwahn, Dr. P., i
 scintillation, 38, *see* stars, scintillation
 Scorpio, 56
 new star in, 388
 seasons, 131, 133, 138, 139
 Secchi, A. (seck'key) (1818–78), *It. ast.*, 235, 384–386
 secular variations, 122, 292
 See, T. J. J., *Am. ast.*, 311, 394, 395, 407
 Serpens, 56
 Serviss, G. P., *Am. ast.*, 55
 Sextans, 56
 sextant, 157
 adjustments, 158
 shadows of heavenly bodies, 258, 259, 269, 270

- shooting stars
 see meteors, 359
 sidereal system, 367
 sidereal time of mean noon, 105
 sight
 model, 41
 taking a, 159
 silicon in sun, 245
 silver in sun, 245
 Sirian stars, 384
 Sirius, 56, 368–371, 382–385, 394
 slit
 dome, 168
 spectroscope, 244
 Snell, W. (1591–1626), Dutch math., 71
 sodium
 in comets, 355
 in sun, 245
 solar constant, 253
 solar disk, the winged, 227
 solar eclipses, *see* eclipses, solar
 solar stars, 384
 solar system
 described, 280
 evolution of, 405
 Solis Lacus on Mars, 315
 solstices, 33, 48, 127, 129
 Sosig'enes, Alex. st., 143
 Southern Cross, 161
 space, infinite, 409
 spectral image test, 176
 spectro-bolometer, 246
 spectroheliogram, spectroheliograph, 238,
 239, 248–250
 spectroscope, 170, 239–243
 spectrum, 239, *see* corona, spectrum, 387
 analysis, 240, 243, 406, 408
 continuous, 240
 discontinuous, 240
 normal solar, 241
 solar, 243–246
 stellar, 384–387, 390
 sun spot, 245
 speculum, 172, 179–181
 sphere
 armillary, 27
 celestial, 25, 37
 parallel, 62
 right, 63, 64
 terrestrial, 24
 Spica (α Virginis), 56, 369, 396
 Spitaler, R., ast. Prague Obs., 350
 Spoerer, F. W. G. (1822–95), Ger. ast., 238
 spring
 in general, 132
 months of, 138
 stadium (pl. stadia), 70
 standard time, *see* time, standard
 star trails, 29–31, 191
 stars, *see* constellations, 367, *see* double
 stars, *see* variable stars, *see* spectrum,
 stellar
 are suns, 17, 367
 brightest, 368
 brightness related to distance, 378
 by night, 11
 catalogues and charts, 52, 53, 56, 371
 circumpolar, 28, 54
 colors, 370
 constitution, 384, 387, 390, 392, 394
 dark, 391
 dimensions, 382
 distances, 382, 383
 distances illustrated, 17, 381
 distances, how found, 378
 distribution, 399
 drift, 375
 grouping, 397, 398
 Herschel's gauges, 399
 in their courses, 51
 light from, 370
 magnitudes of, 52, 367
 motion in line of sight, 375, 378
 multiple, 392, 396
 new, 387, 388, 390
 number of, 11, 12, 368
 parallax, 379, 381, 382
 planets belonging to, 17
 pole, *see* Polaris
 proper motions, 372
 quadruple, 392, 396
 scintillation, 38, 80
 secular changes, 374
 streams, 399
 telling time by, 94
 temporary, 387, 388, 390
 triple, 392, 396
 visible in daytime, 11
 Steinheil, R. (stȳn'hile), Ger. opt., 178
 Stoney, G. J., Brit. physicist, 314
 Struve, F. G. W. (stroo'vũh) (1793–1864),
 Ger.-Russ. ast., 393
 Struve, L., Dir. Kharkov Obs., 375
 v. Struve, O. W. (1819–1905), Ger. ast., 393
 summer
 in general, 132
 months of, 138
 Sumner's method, 160
 Sumner, T. B. (1810–70), Am. navigator, 160
 sun, *see* prominences, 227, *see* photosphere,
 see spectrum, solar, *see* atmosphere,
 of sun, *see* calcium, *see* chromosphere,
 solar, *see* reversing layer, *see* solar
 constant
 absorption by its atmosphere, 247
 apparent annual motion, 115, 127
 brilliance of, 253
 central, 376

- constitution, 244
 contraction of, 254
 declination of, 74, 75
 density, 232
 dimensions, 230, 231
 distance a unit, 228
 distance of, 123, 125, 228, 230
 duration, 407
 eclipses of, *see* eclipses, solar
 elements, 244
 envelopes, 250
 evolution, 405
 faculæ, 234, 235, 238, 239
 fictitious, 96
 gravity at surface, 233
 heat, 253, 407
 light of, 253
 maintenance, 254
 mass, 232, 338
 metals, 244
 midnight, 92
 midsummer, 28, 129
 midwinter, 127, 136
 observing, 233
 overhead at noon, 161
 parallax, 229
 past and future of, 255
 rays at equinox and solstice, 127
 rice grains, 234
 rotation, 239
 ruler, 227
 secular motion, 375
 spherical, 232
 spots, 9, 11, 235
 stellar magnitude, 368
 strength of attraction, 336
 temperature, 254
 veiled spot, 235
 volume, 232
 way (apex), 375, 378
 sundial, 100
 sunrise and sunset, 91, 97
 survey
 gravimetric, 77
 U. S. Coast & Geod., 70, 153
 Swe'denborg, E. (1688–1772), Swed. phil., 406
 Swift, L., Am. ast., 344, 350
 symbols, usual astronomical, 34
 synodic period, *see* moon, period
 syzygy, *see* moon, syzygy

 Tacchini, P. (1838–1905), It. ast., 250
 Taurus, 56
 Taylor, H. D., Eng. opt., 175
 telescope, *see* equatorial telescope, *see* zenith
 telescope, *see* reflector, *see* refractor
 achromatic, 174, 175
 astronomy before, 167
 Cassegrainian, 179
 classified, 169
 early, 173
 great, of future, 179
 Gregorian, 179
 invention, 167, 172, 178
 kinds of, 171
 making a small, 177
 mistakes about, 193
 Newtonian, 179–181
 testing, 176
 tube, 170
 telespectroscope, 243
 telluric lines, 244, 247
 Tempel, E. W. L. (1821–89), Ger. ast., 344,
 350
 terminator, *see* moon, terminator
 Tethys (teth'iz), satellite of Saturn, 306
 Tewfik (teff'ik) (1852–92), Egypt. khedive,
 356
 Thales (B.C. 600), Gk. phil., 67, 257
 Themis, satellite of Saturn, 306
 thermopile, 170
 Thulis, M. (tu-lee') (1750–1805), Fr. ast., 344
 tidal bore, 156
 tidal evolution, 299
 tidal, friction, 407
 tides, 152
 explained by gravitation, 338
 time, 8, *see* equation of time
 all over the world, 111
 apparent, 95
 distribution of, 108
 mean, 96
 measurement of, 99, 100
 observatory, 104
 on board ship, 151
 sidereal and solar, 104
 signals, 163
 standard, 107, 108, 163, 164
 sundial, 100
 telling by the stars, 94
 time-ball, 8, 108, 162, 163
 Tisserand, F. F. (1845–96), Fr. ast., 4
 Titan, satellite of Saturn, 306, 322
 Titania, satellite of Uranus, 307
 titanium in sun, 245
 Titius, J. D. (1726–96), Ger. math., 295
 transit instrument, 169, 183–185
 adjusting, 185
 room, 168
 rudimentary, 102
 transit, triangle, 103
 transits of inferior planets, 300
 transneptunian planets, 326
 triangulation, 71, 229
 Triangulum, 56
 Triesnecker crater, 219, 223, 224
 Trouvelot, L. (1827–92), Fr. ast., 10, 250, 251
 Trowbridge, M. L., photographer, 39

- Tuttle, H. P. (1839–92), Am. ast., 350
twilight, 81
twinkling, *see* stars, scintillation
Tycho Brahe (1546–1601), Danish ast., 48,
219, 343, 388
- U. S. Naval Obs., 178
U. S., National Museum, meteorites, 359, 365
Ulugh-Beg (1394–1449), Arab. ast., 371
Umbriel, satellite of Uranus, 307
unit
 angular, 38
 of celestial distance, 123, 381
universe
 other universes, 409
 stellar, 367
Upton, W., Dir. Brown Univ. Obs., 55
uraninite, 248
Uranus
 albedo, 294
 atmosphere, 309
 axial inclination, 298
 Bode's law, 295
 color, 294
 density, 297
 diameter, 296
 discovery, 325
 distance, 290, 295
 drawings, 326
 eccentricity, 288
 ellipticity, 298
 mass, 297
 meteors near, 362
 naked-eye appearance, 279
 orbit, 287
 period, 289
 rotation, 298
 satellites, 304, 306, 307
 surface of, 325
Ursa Major, 54, 56, 101, 374
Ursa Minor, 53
- vanadium in sun, 245
variable stars, 370, 387, 389, 391
 distribution and observing, 388
Vega, 28, 53, 113, 375, 382–384
Venus, 16
 albedo, 294
 atmosphere, 307
 chart, 312
 color, 294
 conjunctions, 280
 density, 297
 diameter, 296
 distance, 290, 295
 drawings, 311
 eccentricity, 288
 greatest brilliancy, 280
 greatest elongation, 281
 illuminated hemisphere, 311
 inclination, 288
 mass, 297
 naked-eye appearance, 278
 nearest planet, 291
 orbit, 286
 period, 289
 phase, 282, 293
 rotation, 298
 supposed satellite, 303
 transits, 300, 302, 303, 308
 variation in size, 293
vertical circle, defined, 26, 49
Very, F. W., Am. ast., 217
Vesta, small planet, 279, 295, 296, 319
Vienna, meteorites, 359, 364
Virgo, 56
Vogel, H. C. (1841–1907), Ger. ast., 385, 387,
396
volcanoes, 221
Vulpecula, 56
- Walther (1430–1504), Ger. ast., 219
Warner & Swasey, 15, 46, 75, 178, 188
Washington
 Capitol, 85
 meridian of, 107
Watson, J. C. (1838–80), Am. ast., 319
Webb, T. W. (1807–85), Eng. ast., 57
week, 143
Wesley, W. H., Libr. Roy. Ast. Soc., 267
Widmannstätten (vid-mön-stet'yän) figs.,
365
Williams, A. S., Eng. ast., 316, 322
Wilson, H. C., Dir. Carleton Col. Obs., 316,
356, 388
winter
 months of, 138
Wolf, C., Prof. Univ. Paris, 385
Wolf, M., Prof. Univ. Heidelberg, 319, 359,
399, 400
Wolf, R. (1816–93), Ger. ast., 350
Wolfer, A., Dir. Obs. Zurich, 238
Wollaston, W. H. (1766–1828), Eng.
 physicist, 168
Wood, R. W., Johns Hopkins Univ., 332
Wright, W. H. (1711–86), Am. ast., 396
- Yale University, meteorites, 359, 365
year, 142
 anomalous, 143
 sidereal, 142
 tropical, 142
Yerkes, C. T. (yer'kez) (1837–1905), Am.
 patron
 observatory, 7, 176, 376, 378
 telescope, 15, 178, 369
Young, C. A. (1834–1908), Am. ast., 239,
248, 249, 265

- yttrium in sun, 245
- zenith, 22
 - defined, 22, 49
 - distance, defined, 40
- zenith telescope, 74, 75
- zinc in sun, 245
- zirconium in sun, 245
- zodiac, 57, 58
 - signs of, 35
- zodiacal light, 280, 309
- zones, Spörer's law of, 238
- zones, terrestrial, 138

License

A

End of the Project Gutenberg eBook of A New Astronomy, by David Peck Todd

*** END OF THIS PROJECT GUTENBERG EBOOK A NEW ASTRONOMY ***

***** This file should be named 35261-pdf.pdf or 35261-pdf.zip *****

This and all associated files of various formats will be found in:

<http://www.gutenberg.org/3/5/2/6/35261/>

Produced by Susan Skinner, Jonathan Webley, Marilynda
Fraser-Cunliffe and the Online Distributed Proofreading
Team at <http://www.pgdp.net>

Updated editions will replace the previous one--the old editions
will be renamed.

Creating the works from public domain print editions means that no
one owns a United States copyright in these works, so the Foundation
(and you!) can copy and distribute it in the United States without
permission and without paying copyright royalties. Special rules,
set forth in the General Terms of Use part of this license, apply to
copying and distributing Project Gutenberg-tm electronic works to
protect the PROJECT GUTENBERG-tm concept and trademark. Project
Gutenberg is a registered trademark, and may not be used if you
charge for the eBooks, unless you receive specific permission. If you
do not charge anything for copies of this eBook, complying with the
rules is very easy. You may use this eBook for nearly any purpose
such as creation of derivative works, reports, performances and
research. They may be modified and printed and given away--you may do
practically ANYTHING with public domain eBooks. Redistribution is
subject to the trademark license, especially commercial
redistribution.

*** START: FULL LICENSE ***

THE FULL PROJECT GUTENBERG LICENSE
PLEASE READ THIS BEFORE YOU DISTRIBUTE OR USE THIS WORK

To protect the Project Gutenberg-tm mission of promoting the free
distribution of electronic works, by using or distributing this work
(or any other work associated in any way with the phrase "Project
Gutenberg"), you agree to comply with all the terms of the Full Project
Gutenberg-tm License (available with this file or online at
<http://gutenberg.net/license>).

Section 1. General Terms of Use and Redistributing Project Gutenberg-tm
electronic works

1.A. By reading or using any part of this Project Gutenberg-tm
electronic work, you indicate that you have read, understand, agree to
and accept all the terms of this license and intellectual property
(trademark/copyright) agreement. If you do not agree to abide by all
the terms of this agreement, you must cease using and return or destroy

all copies of Project Gutenberg-tm electronic works in your possession. If you paid a fee for obtaining a copy of or access to a Project Gutenberg-tm electronic work and you do not agree to be bound by the terms of this agreement, you may obtain a refund from the person or entity to whom you paid the fee as set forth in paragraph 1.E.8.

1.B. "Project Gutenberg" is a registered trademark. It may only be used on or associated in any way with an electronic work by people who agree to be bound by the terms of this agreement. There are a few things that you can do with most Project Gutenberg-tm electronic works even without complying with the full terms of this agreement. See paragraph 1.C below. There are a lot of things you can do with Project Gutenberg-tm electronic works if you follow the terms of this agreement and help preserve free future access to Project Gutenberg-tm electronic works. See paragraph 1.E below.

1.C. The Project Gutenberg Literary Archive Foundation ("the Foundation" or PGLAF), owns a compilation copyright in the collection of Project Gutenberg-tm electronic works. Nearly all the individual works in the collection are in the public domain in the United States. If an individual work is in the public domain in the United States and you are located in the United States, we do not claim a right to prevent you from copying, distributing, performing, displaying or creating derivative works based on the work as long as all references to Project Gutenberg are removed. Of course, we hope that you will support the Project Gutenberg-tm mission of promoting free access to electronic works by freely sharing Project Gutenberg-tm works in compliance with the terms of this agreement for keeping the Project Gutenberg-tm name associated with the work. You can easily comply with the terms of this agreement by keeping this work in the same format with its attached full Project Gutenberg-tm License when you share it without charge with others.

1.D. The copyright laws of the place where you are located also govern what you can do with this work. Copyright laws in most countries are in a constant state of change. If you are outside the United States, check the laws of your country in addition to the terms of this agreement before downloading, copying, displaying, performing, distributing or creating derivative works based on this work or any other Project Gutenberg-tm work. The Foundation makes no representations concerning the copyright status of any work in any country outside the United States.

1.E. Unless you have removed all references to Project Gutenberg:

1.E.1. The following sentence, with active links to, or other immediate access to, the full Project Gutenberg-tm License must appear prominently whenever any copy of a Project Gutenberg-tm work (any work on which the phrase "Project Gutenberg" appears, or with which the phrase "Project Gutenberg" is associated) is accessed, displayed, performed, viewed, copied or distributed:

This eBook is for the use of anyone anywhere at no cost and with almost no restrictions whatsoever. You may copy it, give it away or re-use it under the terms of the Project Gutenberg License included with this eBook or online at www.gutenberg.net

1.E.2. If an individual Project Gutenberg-tm electronic work is derived from the public domain (does not contain a notice indicating that it is posted with permission of the copyright holder), the work can be copied and distributed to anyone in the United States without paying any fees or charges. If you are redistributing or providing access to a work with the phrase "Project Gutenberg" associated with or appearing on the work, you must comply either with the requirements of paragraphs 1.E.1 through 1.E.7 or obtain permission for the use of the work and the Project Gutenberg-tm trademark as set forth in paragraphs 1.E.8 or 1.E.9.

1.E.3. If an individual Project Gutenberg-tm electronic work is posted with the permission of the copyright holder, your use and distribution must comply with both paragraphs 1.E.1 through 1.E.7 and any additional terms imposed by the copyright holder. Additional terms will be linked to the Project Gutenberg-tm License for all works posted with the permission of the copyright holder found at the beginning of this work.

1.E.4. Do not unlink or detach or remove the full Project Gutenberg-tm License terms from this work, or any files containing a part of this work or any other work associated with Project Gutenberg-tm.

1.E.5. Do not copy, display, perform, distribute or redistribute this electronic work, or any part of this electronic work, without prominently displaying the sentence set forth in paragraph 1.E.1 with active links or immediate access to the full terms of the Project Gutenberg-tm License.

1.E.6. You may convert to and distribute this work in any binary, compressed, marked up, nonproprietary or proprietary form, including any word processing or hypertext form. However, if you provide access to or distribute copies of a Project Gutenberg-tm work in a format other than "Plain Vanilla ASCII" or other format used in the official version posted on the official Project Gutenberg-tm web site (www.gutenberg.net), you must, at no additional cost, fee or expense to the user, provide a copy, a means of exporting a copy, or a means of obtaining a copy upon request, of the work in its original "Plain Vanilla ASCII" or other form. Any alternate format must include the full Project Gutenberg-tm License as specified in paragraph 1.E.1.

1.E.7. Do not charge a fee for access to, viewing, displaying, performing, copying or distributing any Project Gutenberg-tm works unless you comply with paragraph 1.E.8 or 1.E.9.

1.E.8. You may charge a reasonable fee for copies of or providing access to or distributing Project Gutenberg-tm electronic works provided that

- You pay a royalty fee of 20% of the gross profits you derive from the use of Project Gutenberg-tm works calculated using the method you already use to calculate your applicable taxes. The fee is owed to the owner of the Project Gutenberg-tm trademark, but he has agreed to donate royalties under this paragraph to the Project Gutenberg Literary Archive Foundation. Royalty payments must be paid within 60 days following each date on which you prepare (or are legally required to prepare) your periodic tax

returns. Royalty payments should be clearly marked as such and sent to the Project Gutenberg Literary Archive Foundation at the address specified in Section 4, "Information about donations to the Project Gutenberg Literary Archive Foundation."

- You provide a full refund of any money paid by a user who notifies you in writing (or by e-mail) within 30 days of receipt that s/he does not agree to the terms of the full Project Gutenberg-tm License. You must require such a user to return or destroy all copies of the works possessed in a physical medium and discontinue all use of and all access to other copies of Project Gutenberg-tm works.
- You provide, in accordance with paragraph 1.F.3, a full refund of any money paid for a work or a replacement copy, if a defect in the electronic work is discovered and reported to you within 90 days of receipt of the work.
- You comply with all other terms of this agreement for free distribution of Project Gutenberg-tm works.

1.E.9. If you wish to charge a fee or distribute a Project Gutenberg-tm electronic work or group of works on different terms than are set forth in this agreement, you must obtain permission in writing from both the Project Gutenberg Literary Archive Foundation and Michael Hart, the owner of the Project Gutenberg-tm trademark. Contact the Foundation as set forth in Section 3 below.

1.F.

1.F.1. Project Gutenberg volunteers and employees expend considerable effort to identify, do copyright research on, transcribe and proofread public domain works in creating the Project Gutenberg-tm collection. Despite these efforts, Project Gutenberg-tm electronic works, and the medium on which they may be stored, may contain "Defects," such as, but not limited to, incomplete, inaccurate or corrupt data, transcription errors, a copyright or other intellectual property infringement, a defective or damaged disk or other medium, a computer virus, or computer codes that damage or cannot be read by your equipment.

1.F.2. LIMITED WARRANTY, DISCLAIMER OF DAMAGES - Except for the "Right of Replacement or Refund" described in paragraph 1.F.3, the Project Gutenberg Literary Archive Foundation, the owner of the Project Gutenberg-tm trademark, and any other party distributing a Project Gutenberg-tm electronic work under this agreement, disclaim all liability to you for damages, costs and expenses, including legal fees. YOU AGREE THAT YOU HAVE NO REMEDIES FOR NEGLIGENCE, STRICT LIABILITY, BREACH OF WARRANTY OR BREACH OF CONTRACT EXCEPT THOSE PROVIDED IN PARAGRAPH 1.F.3. YOU AGREE THAT THE FOUNDATION, THE TRADEMARK OWNER, AND ANY DISTRIBUTOR UNDER THIS AGREEMENT WILL NOT BE LIABLE TO YOU FOR ACTUAL, DIRECT, INDIRECT, CONSEQUENTIAL, PUNITIVE OR INCIDENTAL DAMAGES EVEN IF YOU GIVE NOTICE OF THE POSSIBILITY OF SUCH DAMAGE.

1.F.3. LIMITED RIGHT OF REPLACEMENT OR REFUND - If you discover a

defect in this electronic work within 90 days of receiving it, you can receive a refund of the money (if any) you paid for it by sending a written explanation to the person you received the work from. If you received the work on a physical medium, you must return the medium with your written explanation. The person or entity that provided you with the defective work may elect to provide a replacement copy in lieu of a refund. If you received the work electronically, the person or entity providing it to you may choose to give you a second opportunity to receive the work electronically in lieu of a refund. If the second copy is also defective, you may demand a refund in writing without further opportunities to fix the problem.

1.F.4. Except for the limited right of replacement or refund set forth in paragraph 1.F.3, this work is provided to you 'AS-IS' WITH NO OTHER WARRANTIES OF ANY KIND, EXPRESS OR IMPLIED, INCLUDING BUT NOT LIMITED TO WARRANTIES OF MERCHANTABILITY OR FITNESS FOR ANY PURPOSE.

1.F.5. Some states do not allow disclaimers of certain implied warranties or the exclusion or limitation of certain types of damages. If any disclaimer or limitation set forth in this agreement violates the law of the state applicable to this agreement, the agreement shall be interpreted to make the maximum disclaimer or limitation permitted by the applicable state law. The invalidity or unenforceability of any provision of this agreement shall not void the remaining provisions.

1.F.6. INDEMNITY - You agree to indemnify and hold the Foundation, the trademark owner, any agent or employee of the Foundation, anyone providing copies of Project Gutenberg-tm electronic works in accordance with this agreement, and any volunteers associated with the production, promotion and distribution of Project Gutenberg-tm electronic works, harmless from all liability, costs and expenses, including legal fees, that arise directly or indirectly from any of the following which you do or cause to occur: (a) distribution of this or any Project Gutenberg-tm work, (b) alteration, modification, or additions or deletions to any Project Gutenberg-tm work, and (c) any Defect you cause.

Section 2. Information about the Mission of Project Gutenberg-tm

Project Gutenberg-tm is synonymous with the free distribution of electronic works in formats readable by the widest variety of computers including obsolete, old, middle-aged and new computers. It exists because of the efforts of hundreds of volunteers and donations from people in all walks of life.

Volunteers and financial support to provide volunteers with the assistance they need are critical to reaching Project Gutenberg-tm's goals and ensuring that the Project Gutenberg-tm collection will remain freely available for generations to come. In 2001, the Project Gutenberg Literary Archive Foundation was created to provide a secure and permanent future for Project Gutenberg-tm and future generations. To learn more about the Project Gutenberg Literary Archive Foundation and how your efforts and donations can help, see Sections 3 and 4 and the Foundation web page at <http://www.pgla.org>.

Section 3. Information about the Project Gutenberg Literary Archive Foundation

The Project Gutenberg Literary Archive Foundation is a non profit 501(c)(3) educational corporation organized under the laws of the state of Mississippi and granted tax exempt status by the Internal Revenue Service. The Foundation's EIN or federal tax identification number is 64-6221541. Its 501(c)(3) letter is posted at <http://pglaf.org/fundraising>. Contributions to the Project Gutenberg Literary Archive Foundation are tax deductible to the full extent permitted by U.S. federal laws and your state's laws.

The Foundation's principal office is located at 4557 Melan Dr. S. Fairbanks, AK, 99712., but its volunteers and employees are scattered throughout numerous locations. Its business office is located at 809 North 1500 West, Salt Lake City, UT 84116, (801) 596-1887, email business@pglaf.org. Email contact links and up to date contact information can be found at the Foundation's web site and official page at <http://pglaf.org>

For additional contact information:

Dr. Gregory B. Newby
Chief Executive and Director
gbnewby@pglaf.org

Section 4. Information about Donations to the Project Gutenberg Literary Archive Foundation

Project Gutenberg-tm depends upon and cannot survive without wide spread public support and donations to carry out its mission of increasing the number of public domain and licensed works that can be freely distributed in machine readable form accessible by the widest array of equipment including outdated equipment. Many small donations (\$1 to \$5,000) are particularly important to maintaining tax exempt status with the IRS.

The Foundation is committed to complying with the laws regulating charities and charitable donations in all 50 states of the United States. Compliance requirements are not uniform and it takes a considerable effort, much paperwork and many fees to meet and keep up with these requirements. We do not solicit donations in locations where we have not received written confirmation of compliance. To SEND DONATIONS or determine the status of compliance for any particular state visit <http://pglaf.org>

While we cannot and do not solicit contributions from states where we have not met the solicitation requirements, we know of no prohibition against accepting unsolicited donations from donors in such states who approach us with offers to donate.

International donations are gratefully accepted, but we cannot make any statements concerning tax treatment of donations received from outside the United States. U.S. laws alone swamp our small staff.

Please check the Project Gutenberg Web pages for current donation

methods and addresses. Donations are accepted in a number of other ways including including checks, online payments and credit card donations. To donate, please visit: <http://pglaf.org/donate>

Section 5. General Information About Project Gutenberg-tm electronic works.

Professor Michael S. Hart is the originator of the Project Gutenberg-tm concept of a library of electronic works that could be freely shared with anyone. For thirty years, he produced and distributed Project Gutenberg-tm eBooks with only a loose network of volunteer support.

Project Gutenberg-tm eBooks are often created from several printed editions, all of which are confirmed as Public Domain in the U.S. unless a copyright notice is included. Thus, we do not necessarily keep eBooks in compliance with any particular paper edition.

Most people start at our Web site which has the main PG search facility:

<http://www.gutenberg.net>

This Web site includes information about Project Gutenberg-tm, including how to make donations to the Project Gutenberg Literary Archive Foundation, how to help produce our new eBooks, and how to subscribe to our email newsletter to hear about new eBooks.